

AXOR



SALES BOOK

Contents

AXOR BRAND

AXOR brand story	6
AXOR history	8
AXOR designers	10
WHY AXOR	14
AXOR Services	16

AXOR COLLECTIONS

AXOR One	20
AXOR Edge	34
AXOR MyEdition	44
AXOR Starck	56
AXOR Starck V	68
AXOR Starck Organic	74
AXOR Citterio	84
AXOR Citterio E	100
AXOR Citterio M	108
AXOR Urquiola	116
AXOR Massaud	124
AXOR Uno	128
AXOR Montreux	138

AXOR PROGRAMS

AXOR Showers	150
AXOR Accessories	176
AXOR Electronic Mixers	194
AXOR base set, drain and overflow set	198

AXOR INDIVIDUALIZATION

AXOR FinishPlus	204
AXOR Signature	210

PLANNING AND INSTALLATION

Planning Examples	216
Checklist	234

AXOR INSPIRATION	238
------------------	-----

AXOR DESIGN DICTIONARY	252
------------------------	-----

AXOR SALES BOOK 2022

Modern bathroom planning is increasingly about expressing personal style. For more than 25 years, AXOR has stood for the design of personal bathrooms. To this end, customers have access to an impressive range of around 2,000 products from the AXOR collections and AXOR programs. The collection and program overviews in the AXOR Sales Manual list all products – from classic to avantgarde – including the key sales arguments to get your customers on board with AXOR. With the AXOR FinishPlus and AXOR Signature customization services, AXOR offers even more options for designing individual bathrooms. Find out how AXOR uses new materials to turn the faucet into a sensuous experience in terms of feel and look in the chapter on customization. Support for shower planning with select product combinations, as well as concrete installation tips, can be found in the Planning and Installation chapter. In the AXOR Inspiration chapter, you will find projects from all over the world that show how AXOR products contribute to the unique style of a hotel or residence. Our Design Lexicon serves as a reference for your sales meetings with design-savvy customers. Here, you will find color-coded explanations of the most important terms from the world of architecture and design.

008

AXOR BRAND



018

AXOR COLLECTIONS

148

AXOR PROGRAMS



204

CUSTOMIZATION

214

PLANNING AND
INSTALLATION

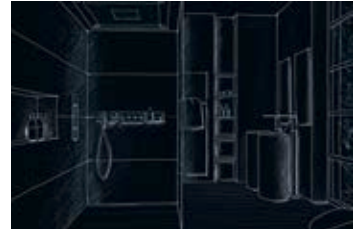

238

AXOR INSPIRATION

252

AXOR DESIGN LEXICON

For us, rooms are more than a home. They are sources of inspiration that turn everyday actions into conscious rituals. The objects used in the process reflect not just the taste, but also the personality of their inhabitants.

From personalities –

7

Our iconic objects for luxury bathrooms and kitchens are created in collaboration with some of the best designers of our time, whose ideas challenge our habits of perception and change our everyday lives. People who live individuality and understand design as an expression of personality.

for personalities

The bathroom and kitchen are among some of our most intimate living spaces, places where we often just take care of ourselves. The element of water we use to do so is a precious commodity. Through outstanding design, we give it a form that unmistakably expresses this appreciation.

FROM PERSONALITIES FOR PERSONALITIES

The AXOR Success Story

For almost 30 years, AXOR has been helping architects, interior designers, and discerning customers express their personalities. AXOR has permanently changed the design and understanding of faucets and bathrooms like no other brand has – from functional sanitary spaces to individual places of wellbeing.

In 1981, Klaus Grohe commissions the first designer faucet for the Hansgrohe Group: Allegroh, designed by Esslinger Design, origin of the famous Frog Design studio. The first faucet collection in color, UNO, becomes an innovative market sensation. In the 1990s, design becomes a hallmark of prestige, and Klaus Grohe discovers its potential for the sanitation industry. This marks the beginning of AXOR's success story as a design brand for luxurious products to make the bathroom and kitchen more personal – inspired and created by world-famous, renowned designers.



- 2006 AXOR Massaud and AXOR Montreux
- 2007 AXOR Citterio M
- 2008 AXOR ShowerCollection – the first shower product range
- 2009 AXOR Urquiola
- 2012 AXOR Starck Organic
- 2013 AXOR WaterDream and product launch of AXOR Showers designed by Front and Nendo

8

1993

Establishment of the AXOR Brand

2003

AXOR Citterio



- 1994 AXOR Starck: Presentation with Salon d'eau by Philippe Starck
- 2000 AXOR WaterDream with PHOENIX – an innovative concept bathroom
- 2003 AXOR Citterio
- 2004 AXOR Starck – Redesign
- 2005 AXOR WaterDream with Patricia Urquiola, Jean-Marie Massaud and Ronan & Erwan Bouroullec



2014

AXOR Starck V,
AXOR Citterio E and
AXOR Universal Accessoires



2017

AXOR Showers
PowderRain

- 2015 AXOR One shower products designed by Barber Osgerby and AXOR WaterDream with the ÉCAL design school
- 2016 AXOR WaterDream "Create your own spout"
- 2017 AXOR Uno redesign and AXOR Showers with the innovative PowderRain spray mode
- 2018 AXOR MyEdition

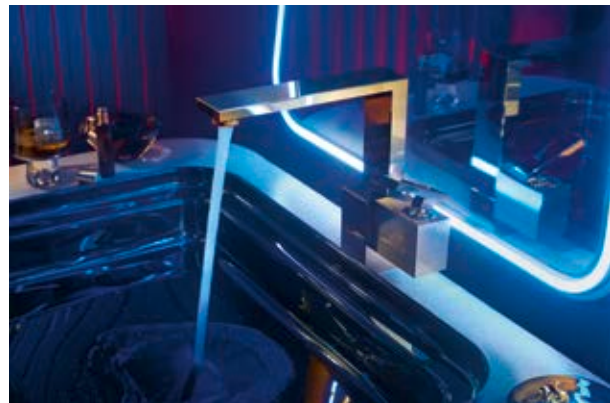

2019 AXOR Edge

2021



2021 AXOR One
AXOR Citterio lever handle variants
AXOR Universal Circular Accessoires

Philippe Starck

DESIGN VISIONARY

Philippe Starck is one of the most famous designers and interior architects of our time. A free spirit with an unconventional style, extroverted and surprising. Starck changes visual habits and plays with materials. As a vision of a better world, his creations bear witness to responsibility to society and the environment.



10



Barber Osgerby

AGENTS OF INTERACTION DESIGN

Barber Osgerby embody the philosophy of interaction design. They stand for the interaction of the user with the product – what they see, hear and need. An art of design that's led to international public commissions and international awards, including the title of Royal Designer for Industry and the Order of the British Empire.

Jean-Marie Massaud

DESIGN ART THAT CONNECTS PEOPLE
AND SPACES

Massaud's unmistakable style provides refreshing stimulation – from product design to architecture. His creations are meant to touch people and provide a better place to live. Strongly influenced by the beauty and utility of nature, he creates synergies between people, design, and space.



Antonio Citterio

MASTER OF ELEGANCE

Nobody else has had an impact on Italian design like Antonio Citterio. As an architect, designer and perfectionist, he creates luxurious objects, interiors and architectural concepts for leading international brands. His signature shows an uncompromising combination of timeless forms and high-quality materials, always under the credo of perfection, of Italian elegance.



Patricia Urquiola

VIRTUOSA OF STYLE FUSION

The Spanish designer enriches the international architecture and design scenes with her feminine design objects. She skillfully combines styles, patterns and materials. She surprises with floral decor, a sensual feel and arouses curiosity with her creations.

12

PHOENIX

DESIGN FOR REAL LIFE

PHOENIX's creations are tailored to people's real needs and desires in their everyday lives. Touching and forward-looking, always driven by logic, morality, and magic.



Nendo

POETIC DESIGN FROM JAPAN

Oki Sato's creations break with convention. And are easy to understand. The name of his office translates as "modeling clay." An indication that his designs are created in a very playful way. This approach has put him at the top of the international design scene.



13

Front

THE SWEDISH "AVANTGARDISTES"

Their design isn't typically Scandinavian. It is experimental, a play with visual effects inspired by fashion, film, and science. Their trademark is their ironic point of view and the joy of surprise. Qualities that have the international design scene buzzing.



Why

SIX REASONS TO CHOOSE AXOR

01 Design diversity

AXOR collaborates with internationally renowned designers. With their highly distinct signatures, they shape the great stylistic diversity and product depth of the AXOR range. Their design approaches set standards again and again – in terms of their avantgarde designs, which are innovative and timeless at the same time. As part of AXOR WaterDreams, designers from completely different disciplines create their vision of the bathroom of the future, completely detached from a product-oriented development. With their ideas, they provide new inspiration for the development of the space, its use, and matching products.

In the following collections, unique water designs create extraordinary haptic and visual experiences – with innovative spray modes and a completely new way of presenting water:

- AXOR Massaud with a natural looking waterfall
- AXOR Starck Organic with the gentle shower spray on a faucet for the first time
- AXOR Starck V with powerful water vortex
- AXOR MyEdition with PowderRain – fitting the faucet design



02 Individualization

The exclusive AXOR FinishPlus and AXOR Signature customization services meet customers' increasing demand for more options to customize bathroom products. With colored PVD surfaces and customized solutions, AXOR products become unmistakably unique.

03 Made in Germany

At AXOR's own factory at its headquarters in Schiltach, Germany, the first-class brand products are created with German engineering quality and a deep commitment to precision – in every detail. This know-how builds on the Hansgrohe Group's more than 120 years of experience, as well as the expertise of every single skilled worker. AXOR is also a pioneer in innovative manufacturing technologies, such as the latest generation diamond drilling machine for ultra-precision milling of surfaces in the AXOR Edge collection.



04 Worldwide presence

As part of the Hansgrohe Group, AXOR has 32 subsidiaries and 22 sales offices worldwide and supplies its products to over 146 countries. AXOR faucets, showers, and kitchen faucets can be found in the world's finest homes, hotels, and restaurants. International architects, planners, and builders trust AXOR quality in products and expert advice.

15

05 Understanding sustainability

Efficient use of resources is important to AXOR – from water-saving products and resource-efficient material use in production to durability in design, functionality, and quality. One example: the AXOR Starck Organic basin faucet with particularly low water consumption.

06 International design awards

AXOR's design achievements – marked by independent, internationally renowned industry experts – are confirmed by the numerous awards the brand has received for first-class product design since the very beginning. These include:

- Red Dot Best of Best for AXOR Edge
- German Design Award for AXOR MyEdition
- iF Design Award in Gold for AXOR One and AXOR Uno
- Green Design Award for AXOR Starck Organic



reddot design award

Maximum services



AXOR FINISHPLUS AND AXOR SIGNATURE

With these customization services, AXOR answers customers' personal wishes and the demand for distinctive design. More at: [axor-design.com](https://www.axor-design.com)



FIVE-YEAR MANUFACTURER'S GUARANTEE

The manufacturer's warranty extends beyond the legally required period and underlines AXOR's quality claim. In addition, strict quality management is already applied during the manufacturing process to ensure products meet the high requirements of independent testing institutes and legal regulations. Please note the warranty conditions at: [axor-design.com/us/service/product-guarantee](https://www.axor-design.com/us/service/product-guarantee)



15 YEARS GUARANTEED AVAILABILITY

Fifteen years guaranteed availability for spare parts for AXOR products ensures a secure investment. All information and products is fast and easy to find online in the Spare Parts Shop: [spares.hansgrohe.com](https://www.spares.hansgrohe.com)



PROFESSIONAL WEBSITE

On the portal, specialist retailers, architects, and installers can find information, planning data, and prices for all products, as well as practical tips and tools for professional bathroom planning and advice. More at: [pro.hansgrohe.com](https://www.pro.hansgrohe.com)

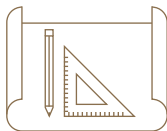

PLANNING DATA

Installation and service instructions, dimensional drawings, BIM planning data and 3D data for optimal bathroom planning with AXOR products can also be found in the professional portal: [pro.hansgrohe.com](https://www.pro.hansgrohe.com)



COMFORTZONE TEST

Create the perfect combinations of faucets and sinks in this internal test center. For this purpose, matching sinks from leading manufacturers are tested with AXOR products for optimal functionality and appearance. All recommended combinations can be found on the AXOR website on the respective collection page: axor-design.com



MEISTERSERVICE

AXOR service specialists are trained sanitation experts with advice on technical issues - by phone, email, or chat. In special cases, a specialist for building services can also be available on site. If required, local contacts are available by phone or e-mail: service@axor-design.com



PROJECT CONSULTATION

AXOR offers professional support and advice for project tenders and planning worldwide. If required, please contact your local contact partner or send an email to: service@axor-design.com

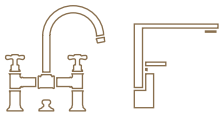

BATHROOM EXHIBITION

Experience AXOR live worldwide: The WaterStudios in architectural and design metropolises are sources of inspiration and meeting places, design and training centers for trade partners, architects, and interior designers. In the Aquademie at the brand's headquarters in Schiltach, Germany, visitors and trade partners can experience a bathroom and kitchen world over 1,000 square meters with a museum on the history of the bathroom, the company, and the brand, regular events, and a Showerworld for test showers.



ONLINE AQUADEMIE

You can access the newly developed Hansgrohe Online Aquademie via the trade partner website. Here, partners in the trade and crafts can benefit from detailed knowledge on the topics of products and sanitation technology, as well as from non-technical highlights. More information at: aquademie-seminars.hansgrohe.com

AXOR Collections

Each AXOR collection has its own character. The respective mixers, showers, wash basins, bathtubs and accessories – all of uniform design. The unique variety of styles from classic to modern was developed in cooperation with world renowned designers.



AXOR ONE
The essence of simplicity

20



AXOR EDGE
The power of architectonics

34



AXOR MY EDITION
A personal statement

44



AXOR STARCK
Minimalist bathroom design

56



AXOR STARCK V
The vitality of water

68



AXOR STARCK ORGANIC
Sense and sensibility

74



AXOR CITTERIO
A celebration of water

84

AXOR CITTERIO E
The essence of elegance

100



AXOR CITTERIO M
Urban lifestyle

108



AXOR URQUIOLA
Poetry for the senses

116



AXOR MASSAUD
The peace of nature

124



AXOR UNO
The power of simplicity

128



AXOR MONTREUX
The tradition of industrial design

138





AXOR ONE

The essence of simplicity

A bathroom collection so elegant, elemental and pure, it could be realized only through radical innovation. Whether at the wash basin, bathtub or shower, familiar archetypes have been reinvented for greater clarity, enhanced function and superior control. Timeless by design, and available in Chrome, Matt Black and an array of exclusive AXOR FinishPlus surfaces, AXOR One brings exquisite beauty to any bathroom.

Design: Barber Osgerby

“AXOR ONE PROVOKES THE MEMORY OF WATER BUT HERALDS A NEW WAY OF CONTROLLING IT THAT IS MUCH MORE PRECISE AND INCREDIBLY REFINED.”

Edward Barber and Jay Osgerby

CHARACTERISTIC DESIGN FEATURE:

Minimalist design: A familiar archetype with new, innovative interaction.

THE DESIGNER'S IDEA:

Challenging the archetype through the pursuit of art and science, invention and interaction.

SPECIAL COLLECTION HIGHLIGHTS:

- / Holistic design language of slender silhouettes, flat surfaces, soft corners and balanced **proportions**
- / Using Select technology: The mechanical faucet handles enable precise, water-saving on/off and temperature control
- / A collection of elegant archetypes for the wash basin, bathtub and shower
- / The action is effortless, intuitive and ultra-precise, and this same inventive design thinking characterizes the entire collection
- / Maximum **individualization:** The exclusive lacquered surface finish Matt Black

The essence of simplicity with new interaction

A collection of elegant archetypes for the wash basin, bathtub and shower, AXOR One is unified by a holistic design language of slender silhouettes, flat surfaces, soft corners and balanced proportions. The iconic mixers feature a gentle taper to their curved spouts, a subtle detail that signals exceptional quality of design and manufacturing. Utilizing Select technology, the mechanical mixer handles enable precise, water-saving on/off and temperate control.

FAMILIAR ARCHETYPE

The archetypical round arch lends the faucet a familiar design, while innovations make it a new, state-of-the-art product

GENTLE TAPERED SPOUT

A subtle detail that signals both precision and exceptional quality of design and manufacturing

MINIMALIST DESIGN

Reduced to the minimum, the product is simple in form and function

MATT BLACK

New lacquered surface finish Matt Black, exclusively available for AXOR One

SELECT TECHNOLOGY

WITH COOLSTART FUNCTION

The mechanical Select handle enables effortless, intuitive and ultra-precise control and includes a preset CoolStart function

22



ON/OFF:

Press down on its all-in-one controller – the Select handle – to start or stop the water.

TEMPERATURE CONTROL:

Swivel clockwise to increase the temperature. The handle includes a preset CoolStart function, an environmentally friendly technology that helps conserve resources.

Wash basin Select



Basin mixer Select 140
with push-open waste set
48010, -000, -670, -xxx



Basin mixer Select 170
with push-open waste set
48020, -000, -670, -xxx



Basin mixer Select 260
for wash bowls with push-open
waste set
48030, -000, -670, -xxx



2-hole basin mixer Select 260
with push-open waste set
48060, -000, -670, -xxx



Basin mixer for concealed
installation wall-mounted
Select with spout 220 mm
48112, -000, -670, -xxx

Basic set
13625180



3-hole basin mixer Select 170
with push-open waste set
48070, -000, -670, -xxx



Electronic basin mixer
with temperature pre-adjustment
with mains connection 230 V
38010, -000, -670, -xxx

Basic set
16182180



/ Due to technical reasons
this product is not available
in the surface finishes Red
Gold and Black Chrome



Electronic basin mixer
for concealed installation
wall-mounted with spout 225 mm
38120, -000, -670, -xxx

with spout 165 mm (not shown)
38119, -000, -670, -xxx

Basic set
16180180



Electronic

23



NEW INTERPRETATION OF A 3-HOLE BASIN MIXER

The soft designed handles are very gentle to the touch. By pushing the right handle, with its integrated Select technology, you can start and stop the water flow. By turning the right handle, you can change the temperature. By turning the left handle, you can adjust the water flow. This control logic allows for pre-settings for temperature and volume.

An innovative idea makes exceptional design come true



Positioning the cartridge underneath the wash basin makes the exceptionally slim silhouette possible. At the same time, it allows for fast and easy installation as well as easy service and maintenance: Only the waterpipe needs to be removed, while the cartridge can be easily released thanks to a bayonet clasp.

BAYONET CLASP
Easy and fast installation of cartridge underneath the wash basin

WATERPIPE CONNECTION
Ensures water flow from the cartridge to the mixer



Wash basin lever handle



Single lever basin mixer 70 with lever handle and pop-up waste set
48000, -000, -670, -xxx
with waste set (not shown)
48001, -000, -670, -xxx



Single lever basin mixer 260 with lever handle and waste set
48002, -000, -670, -xxx



Single lever basin mixer for concealed installation wall-mounted with lever handle and spout 220 mm
48120, -000, -670, -xxx

Basic set
13623180



3-hole basin mixer 170 with push-open waste set
48050, -000, -670, -xxx

Bidet



Single lever bidet mixer with pop-up waste set
48210, -000, -670, -xxx



The minimalist design story continues with the wash basin mixers with lever handle. The new M25XS cartridge allows for a new flat handle design. The integrated aerator and the slightly tapered spout emphasizes the quality of design and manufacturing.

Monolithic design for the shower

The AXOR One overhead showers and hand showers feature **monolithic** forms and an innovative organization of Rain and PowderRain spray types, reflected in the distinctive graphic language of the showerhead's spray disc. The AXOR One showerpipe is the perfect all-in-one combination of overhead shower, hand shower, wall bar and wall outlet. The showerpipe and shower set offer a clean appearance thanks to their integrated wall outlet. The entire collection can be personalized in Matt Black or an exclusive AXOR FinishPlus surface.

26

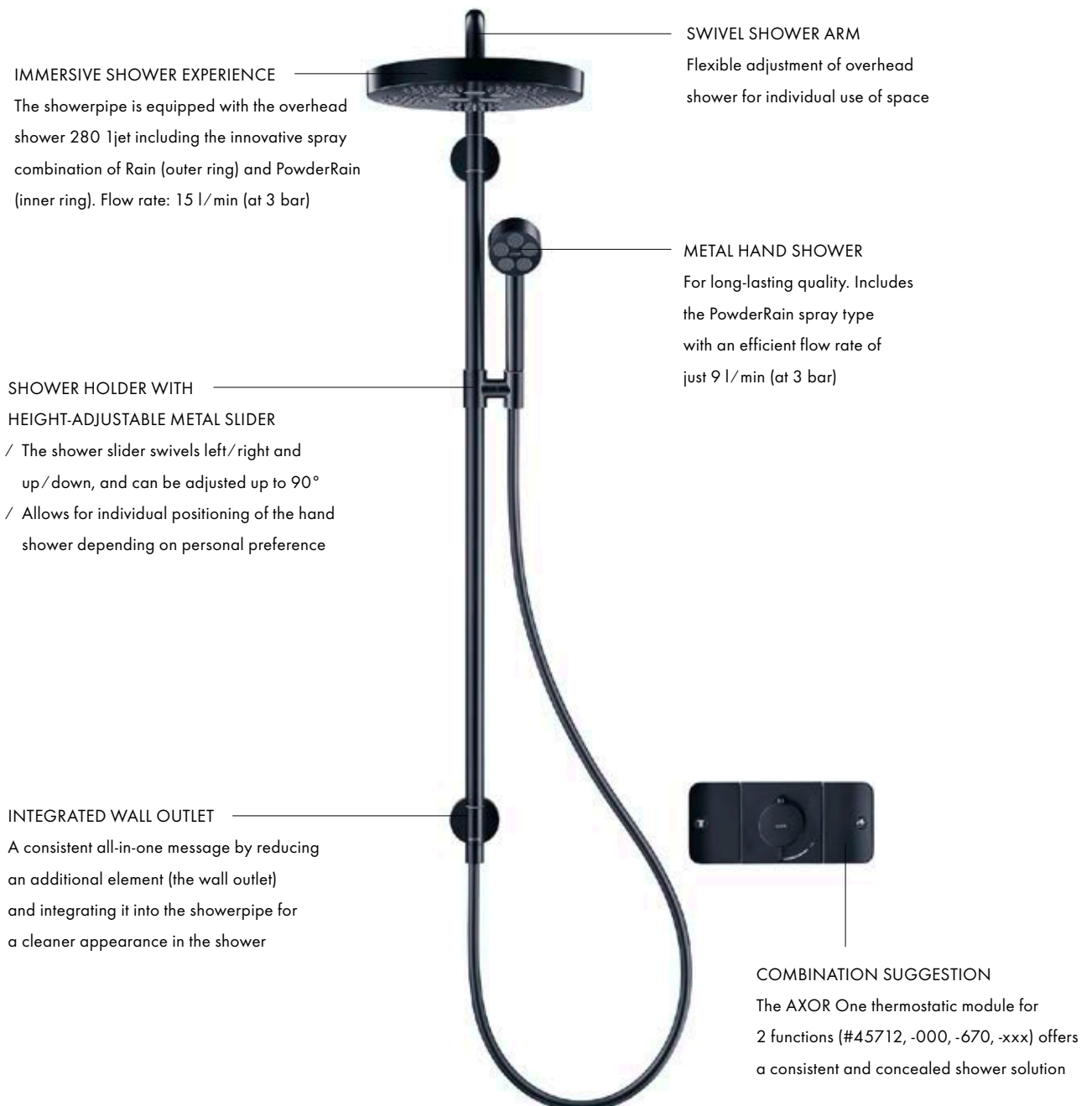

Shower



Showerpipe 280 1jet
for concealed installation
48790, -000, -670, -xxx

Basic set
48798180



Overhead shower 280 2jet
with shower arm
48492, -000, -670, -xxx

Basic set 2jet
35361180



Overhead shower 280 1jet
with shower arm
48491, -000, -670, -xxx



/ Connection thread G 1/2



Overhead shower 75 1jet EcoSmart
with shower arm
48490, -000, -670, -xxx



/ Connection thread G 1/2



Overhead shower 280 2jet
with ceiling connection
48494, -000, -670, -xxx

Basic set
26434180

Ceiling connector 300 mm
for overhead shower 280 2jet
(not shown)
48496, -000, -670, -xxx



Overhead shower 280 1jet
with ceiling connection
48493, -000, -670, -xxx

Ceiling connector 300 mm
for overhead shower 280 1jet
(not shown)
48495, -000, -670, -xxx



/ Connection thread G 1/2



Ceiling connector 300 mm
for overhead shower 280 2jet
48496, -000, -670, -xxx

/ Connection thread G 1/2



Ceiling connector 300 mm
for overhead shower 280 1jet
48495, -000, -670, -xxx

/ Connection thread G 1/2



Shower



Shower set 75 1jet EcoSmart
with wall connection
48791, -000, -670, -xxx



/ Including hand shower 1jet
(# 48651, -000, -670, -xxx)



Wall bar with wall connection
48792, -000, -670, -xxx

/ Combinable with hand shower
1jet (# 48651, -000, -670, -xxx)
or other AXOR hand showers



Shower set 0.90 m
with hand shower 2jet
45722, -000, -xxx



/ Horizontally positioned hand
shower enhances the revitalizing
effect of the flood spray



Hand shower 75 1jet EcoSmart
48651, -000, -670, -xxx



/ Metal hand shower for
a long-lasting quality



Hand shower 2jet
45720, -000, -670, -xxx



/ Easily change spray modes
using the Select technology



Porter unit
45723, -000, -670, -xxx

/ For shower hoses with
cylindrical nuts on both sides

One shower control uniting all functions



The AXOR One thermostat module combines all functions in a single control element for intuitive control of all consumers. Based on the user-friendly Select technology, operated by pressing instead of turning. The Select paddles have mechanical controls, offering high precision.

TEMPERATURE REGULATION:

- / Precisely controllable with the large, cylindrical knob
- / Safety lock limits temperature to 40°C
- / Adjustable maximum temperature



OUTLET CONTROL:

- / Large Select paddles turn the water on and off easily
- / Complete control with finger, hand or even elbow operation
- / Up to three functions can be activated - separately or at the same time
- / A porter can be added

VOLUME CONTROL:

- / For economical water consumption
- / Volume control reduces water flow continuously by up to 50% - depending on flow volume and installation configuration

OPERATION:

- / Large symbols on the paddles indicate clearly which outlet is being used
- / The paddle icons can be applied easily after installation



Thermostatic module for concealed installation for 3 functions
45713, -000, -670, -xxx

Basic set
45710180



Thermostatic module for concealed installation for 2 functions
45712, -000, -670, -xxx

Basic set
45710180



Thermostatic module for concealed installation for 1 function
45711, -000, -670, -xxx

Basic set
45710180



Shut-off valve for concealed installation
45771, -000, -670, -xxx

Basic set
45770180







Single lever bath mixer floor-standing
48440, -000, -670, -xxx

Basic set
10452180



/ Diverter is integrated into the spout



Bath spout curved floor-standing
38412, -000, -670, -xxx

Basic set
10452180



Bath spout curved
38411, -000, -670, -xxx



Finish set oval
28022, -000, -xxx

Basic set
15490180

- / sBox for quiet, smooth and safe hose guiding
- / Suitable for rim- or tile-mounted installation
- / Bath rim width at least 100 mm
- / Maximum pull-out length of individually selectable hand shower: 1.45 m



Due to its minimalist appearance, the floor-standing AXOR Uno bath spout (# 38412, -000, -670, -xxx) is a perfect match with the AXOR One collection.





AXOR Edge

The power of architectonics

AXOR Edge is a masterpiece in the tradition of the early 20th century avant-garde. Cubes, the distinctive design element, are put together *asymmetrically* to form an *architectonic sculpture*. In addition to the geometric shapes, the collection is characterized by the ultra-precision of its surfaces and edges, which turns the fixtures into brilliant, high-gloss jewels for the bathroom.

Design: Jean-Marie Massaud

“WITH AXOR EDGE, WE
EXPLORE THE WORLD OF
EXTREME REFINEMENT
AND UNIQUENESS.”

Jean-Marie Massaud

CHARACTERISTIC DESIGN FEATURE:

Avant-garde design: Asymmetrically arranged blocks create a mixer that is an *architectonic sculpture*.

THE DESIGNER'S IDEA:

Jewels for the bathroom: With AXOR Edge we wanted to make a *sculpture* out of an object we use every day, a sculpture that evokes emotion with its precise edges, high-gloss surfaces and refined structures.

SPECIAL COLLECTION HIGHLIGHTS:

- / High-gloss surfaces: The brilliance is generated by especially precise milling of the surfaces and edges
- / New production technology: Using a diamond-cutting machine of the latest generation. It sets new technological standards in the manufacturing process. The precision is comparable to that of the watch, jewelry and optical industries
- / *Diamond-cut*: Fine, *luxurious* structural details provide exciting contrasts and a special sensory experience
- / Complete set of bathroom fittings: Mixers for the wash basin and bathtub as well as thermostats for the shower
- / AXOR Edge is the second collection created in cooperation with French star designer Jean-Marie Massaud

Learn more about AXOR Edge:

axor-design.com

The genesis of a masterpiece

When diamonds are used in a production process, it's to ensure the greatest precision and the finest details with the most refined materials. Precision is the foundation for brilliance, and production with diamonds is the benchmark for perfect surfaces and edges. Manufacturing AXOR Edge depends on precision to thousandths of a millimeter. An exactness that is realized by using a diamond-cutting machine of the newest generation, a tool like those used in the aerospace and laser industries.

The beveled chamfers are milled at an angle of exactly 45° and join together with absolute precision. This creates a surface without any unevenness, which reflects light perfectly. Standards for testing gloss level in quality assurance, redefined especially for this collection, ensure that exactly these high requirements are met.

36

The fine pattern structures are created with the same precision: the *diamond cut*. By milling the solid block of brass line by line in several steps, precise pyramid frustums are formed, creating a *luxurious* detail that provides exciting contrasts.



RIGHT: A line that will become a *diamond cut* in the finished appearance is milled up to five times.

LEFT, TOP AND BOTTOM: A diamond is used to mill the beveled chamfer at an angle of exactly 45° to a high gloss.

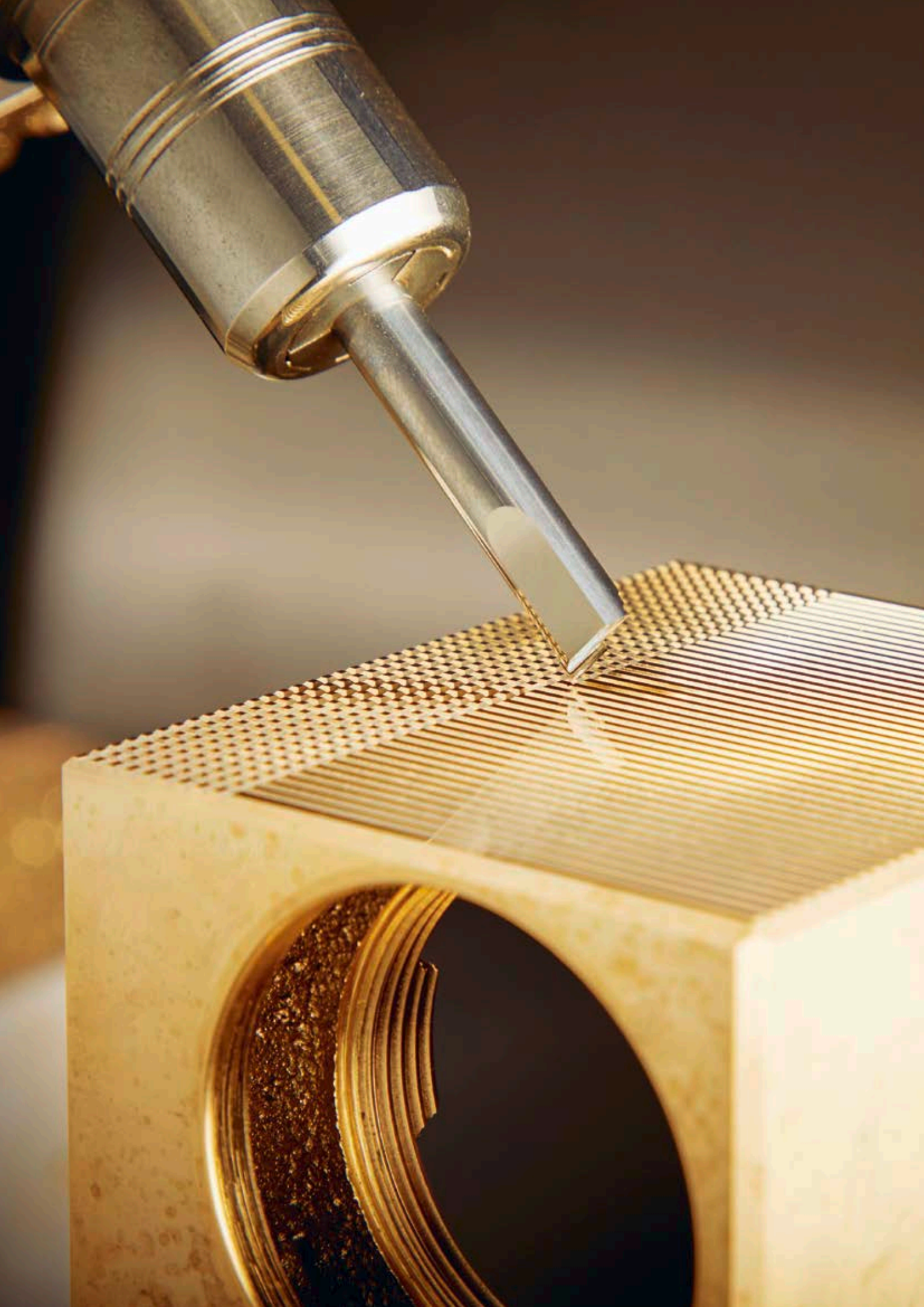

Bringing high-gloss and ultra-precision together in one mixer

AXOR Edge mixers break through boundaries: High-gloss surfaces are a striking feature of the collection. To achieve this brilliance, the highest precision is required in production so that light breaks perfectly on the surface of the mixer. That's why a diamond-cutting machine is used. It creates facets on the surfaces and chamfers of the mixer with precision to the micrometer, generating a fascinating play of light and shadow. Exactly these precise details – the meticulous 45° chamfer and the innovative, three-dimensional **diamond cut** – turn the mixer into a gem.

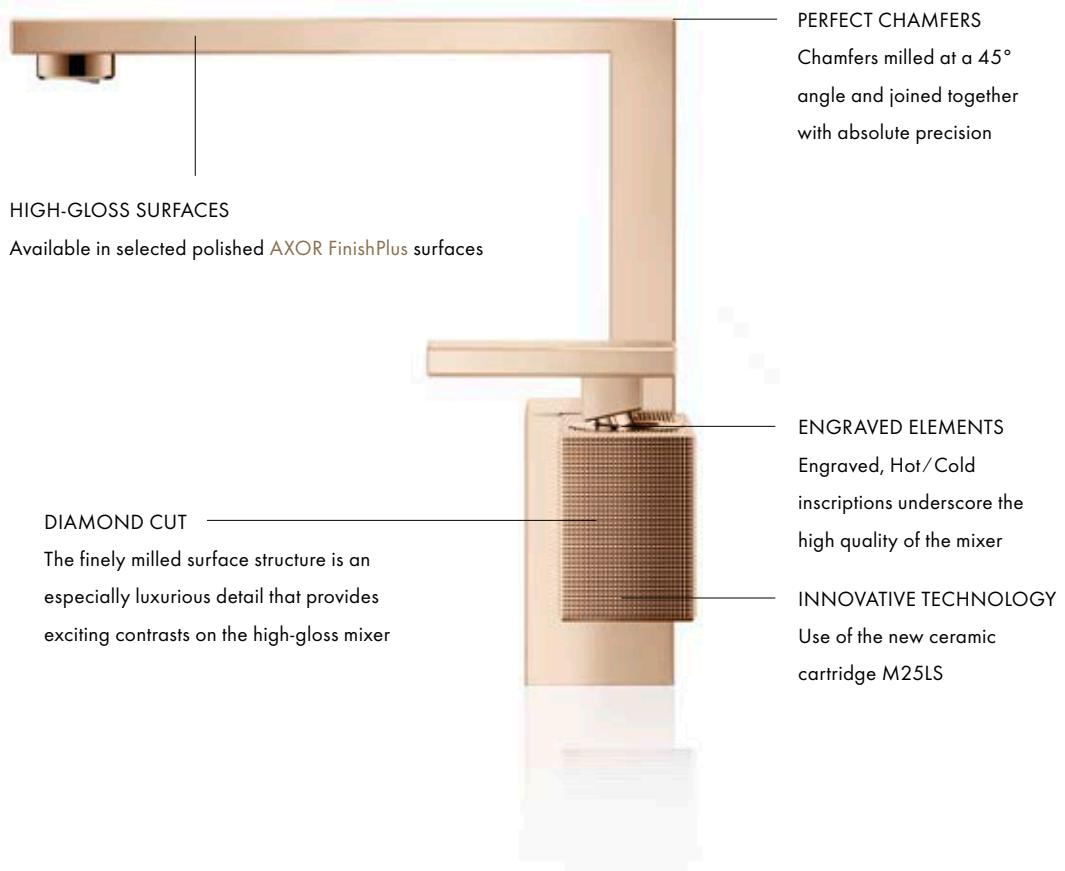

Wash basin



Single lever basin mixer 130
with push-open waste set
46010, -000, -xxx
with diamond cut (not shown)
46011, -000, -xxx



Single lever basin mixer 190
with push-open waste set
46020, -000, -xxx
with diamond cut (not shown)
46021, -000, -xxx



Single lever basin mixer 280
with push-open waste set
46030, -000, -xxx
with diamond cut (not shown)
46031, -000, -xxx



3-hole basin mixer 130
with push-open waste set
46050, -000, -xxx
with diamond cut (not shown)
46051, -000, -xxx



3-hole basin mixer
for concealed installation
wall-mounted with spout 190 mm
46060, -000, -xxx
with diamond cut (not shown)
46061, -000, -xxx

Basic set
10303180



Single lever basin mixer
floor-standing
with push-open waste set
46040, -000, -xxx
with diamond cut (not shown)
46041, -000, -xxx

Basic set
10452180



Bidet



Single lever bidet mixer
with push-open waste set
46210, -000, -xxx
with diamond cut (not shown)
46211, -000, -xxx





The AXOR Edge concealed thermostat module Select for five functions offers optimum control for the AXOR ShowerHeaven 1200/300 4jet. With the generously sized Select buttons, control is intuitive. Operate up to five spray modes or showers mechanically at the press of a button.

EASY TO SELECT OUTLETS

Selecting the proper outlet is simple thanks to engraved, easy to read icons

VOLUME CONTROL

Control volume with the on/off function for water flow

DIAMOND CUT

The three-dimensionality of the diamond cut, with its precise pyramid frustums, creates a new sensory experience

TEMPERATURE ADJUSTMENT

Thermostatic mixer with clear temperature display

INTUITIVE OPERATION

Large Select buttons enable intuitive operation



Shower



Single lever shower mixer for concealed installation
46650, -000, -xxx
with diamond cut (not shown)
46651, -000, -xxx



Porter unit with baton hand shower 2jet and shower hose
46520, -000, -xxx
with diamond cut (not shown)
46521, -000, -xxx

/ Spray mode: Rain, Mono



Thermostat for exposed/concealed installation for 2 functions
46240, -000, -xxx
with diamond cut
46241, -000, -xxx

Basic set
45442180



Thermostat for exposed/concealed installation for 3 functions
46140, -000, -xxx
with diamond cut (not shown)
46141, -000, -xxx

Basic set
45443180



Thermostatic module Select 470/100 for concealed installation for 2 functions
46700, -000, -xxx
with diamond cut (not shown)
46701, -000, -xxx

Basic set
18310180



Thermostatic module Select 540/100 for concealed installation for 3 functions
46710, -000, -xxx
with diamond cut (not shown)
46711, -000, -xxx

Basic set
18311180



Thermostatic module Select 610/100 for concealed installation for 4 functions
46720, -000, -xxx
with diamond cut (not shown)
46721, -000, -xxx

Basic set
18312180



Thermostatic module Select 680/100 for concealed installation for 5 functions
46730, -000, -xxx
with diamond cut (not shown)
46731, -000, -xxx

Basic set
18313180



Thermostat HighFlow for concealed installation with shut-off valve
46740, -000, -xxx
with diamond cut (not shown)
46741, -000, -xxx

Basic set iBox universal
01700180



Thermostat for concealed installation with shut-off valve
46750, -000, -xxx
with diamond cut (not shown)
46751, -000, -xxx

Basic set iBox universal
01700180



Thermostat for concealed installation with shut-off/diverter valve
46760, -000, -xxx
with diamond cut (not shown)
46761, -000, -xxx

Basic set iBox universal
01700180



Shut-off valve for concealed installation
46770, -000, -xxx
with diamond cut (not shown)
46771, -000, -xxx

Basic set 52 l/min spindle
16973180
Basic set 40 l/min ceramic
16974180
Basic set 130 l/min spindle
16970180

Innovative technology in the bathtub for more freedom of movement and maximum comfort

42



Suitable for bathtub rim installation

The hose is protected from external effects and runs quietly

The hose is weighted for safe, smooth hose retraction



USER-FRIENDLY, CONVENIENT HOSE COILING SYSTEM

The sBox for bathtubs features an innovative hose coiling system included in the scope of delivery for the basic set of the AXOR Edge three-hole single lever rim-mounted mixer and the basic set of the AXOR Edge rim-mounted set. With the sBox, the hose coils up smoothly, quietly and safely. The hand shower's maximum extended length is 1.45 m.



Single lever bath mixer
for concealed installation
46450, -000, -xxx
with diamond cut (not shown)
46451, -000, -xxx
Basic set iBox universal
01700180



Single lever bath mixer
for concealed installation
with integrated security combination
according to EN1717
46420, -000, -xxx
with diamond cut (not shown)
46421, -000, -xxx
Basic set iBox universal
01700180



3-hole rim mounted bath mixer
46430, -000, -xxx
with diamond cut (not shown)
46431, -000, -xxx
Basic set
15487180



/ Incl. baton hand shower 2jet
(# 28532, -000, -xxx)
/ With the integrated sBox,
the hose coils up smoothly,
quietly and safely



Rim mounted bath set
46470, -000, -xxx
Basic set
15490180



/ Incl. baton hand shower 2jet
(# 28532, -000, -xxx)
/ With the integrated sBox,
the hose coils up smoothly,
quietly and safely



Bath spout
46410, -000, -xxx
with diamond cut (not shown)
46411, -000, -xxx



Single lever bath mixer
floor-standing
46440, -000, -xxx
with diamond cut (not shown)
46441, -000, -xxx
Basic set
10452180





AXOR MyEdition

A personal statement

With its **monolithic**, linear **design**, AXOR MyEdition provides you with a stage for self-expression. A wide selection of cover plates made of exclusive materials leaves room for your own creativity. The collection responds to a human desire to have something unique, to stand out from the crowd and to move in new directions.

Design: PHOENIX

“AXOR MYEDITION OFFERS
PERFECTLY COORDINATED,
MULTISENSORY
EXPERIENCES.”

Andreas Diefenbach, PHOENIX

CHARACTERISTIC DESIGN FEATURE:

Monolith: The distinctive rectangle, due to its weight and size, is monolithic.

THE DESIGNER'S IDEA:

A stage for your own creativity: Numerous options for individualization offer customers a platform for self-realization.

SPECIAL COLLECTION HIGHLIGHTS:

- / With the neutral carrier plate, AXOR MyEdition lets you create a customized design using the custom material plate
- / A new dimension of **individualization** with carefully selected natural materials and exclusive surface finishes
- / A new look and feel with the use of natural materials such as glass, metal, wood, marble and leather, each with its own unique surface structure
- / A **sensual** contrast to linear **design**: Innovative water design with the velvety soft PowderRain spray mode, available for the first time on a wash basin mixer
- / Isolated water conduction: Prevents direct water contact with the body of the mixer
- / Integration or contrast: The perfect complement to the **interior design** or a statement in the bathroom

Learn more about AXOR MyEdition:

axor-design.com

An avant-garde concept and an ingenious connection

A metal body with a chrome finish or one of the AXOR FinishPlus PVD surface. Crowned with a fascinating cover plate: With its exclusive material portfolio, AXOR Signature opens up groundbreaking potential. Metal, mirror glass, black glass and refined natural materials such as wood, marble and leather offer more appeal and new sensory experiences. AXOR MyEdition is the first.

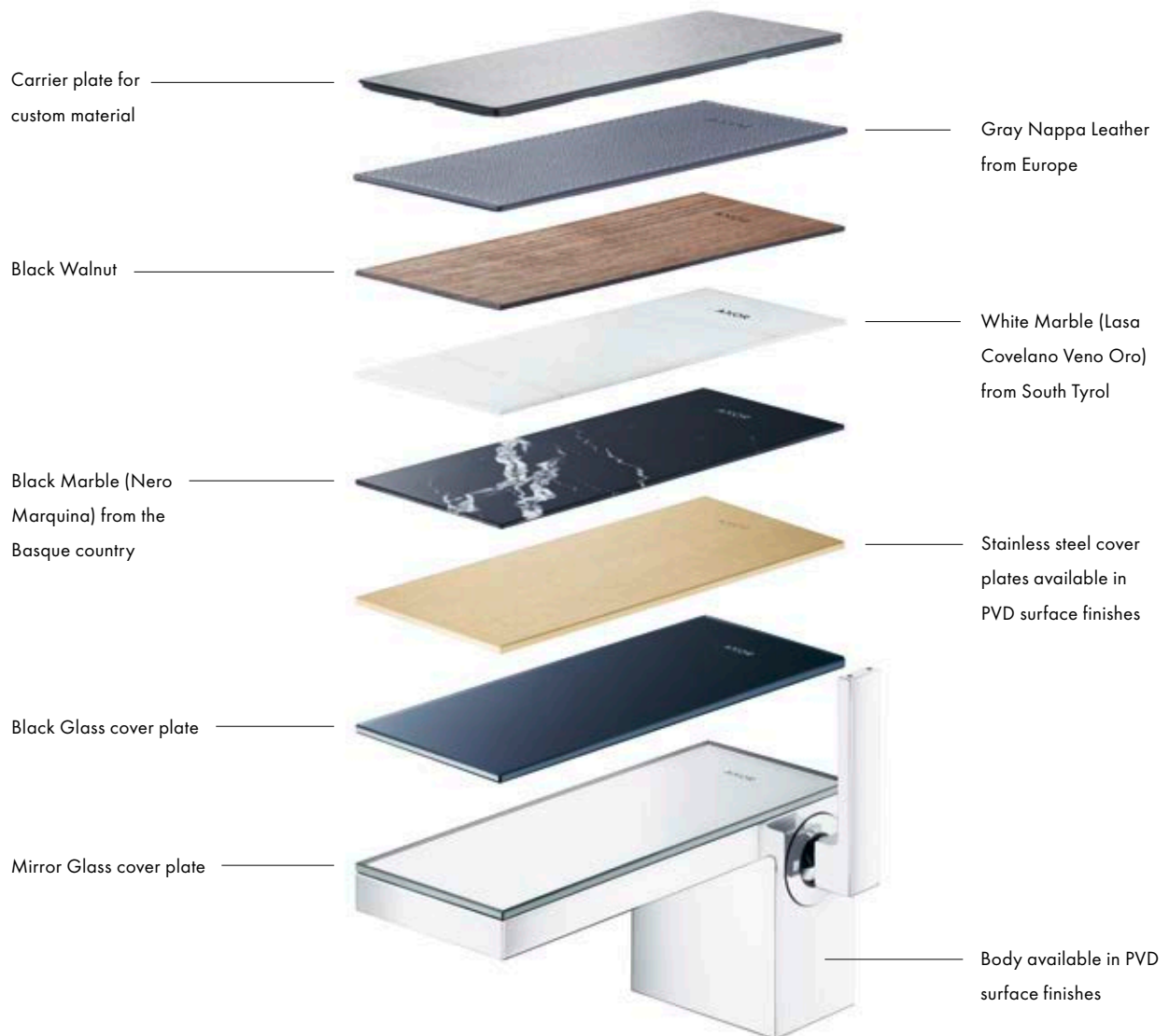

The following variants are available as standard for all nine AXOR MyEdition products with their own item numbers:

- / Chrome (body) / Mirror Glass (cover plate) (-000)
- / Chrome / Black Glass (-600)

In addition to the standard variants, the products can be configured individually and ordered with separate item numbers for body and cover plate.

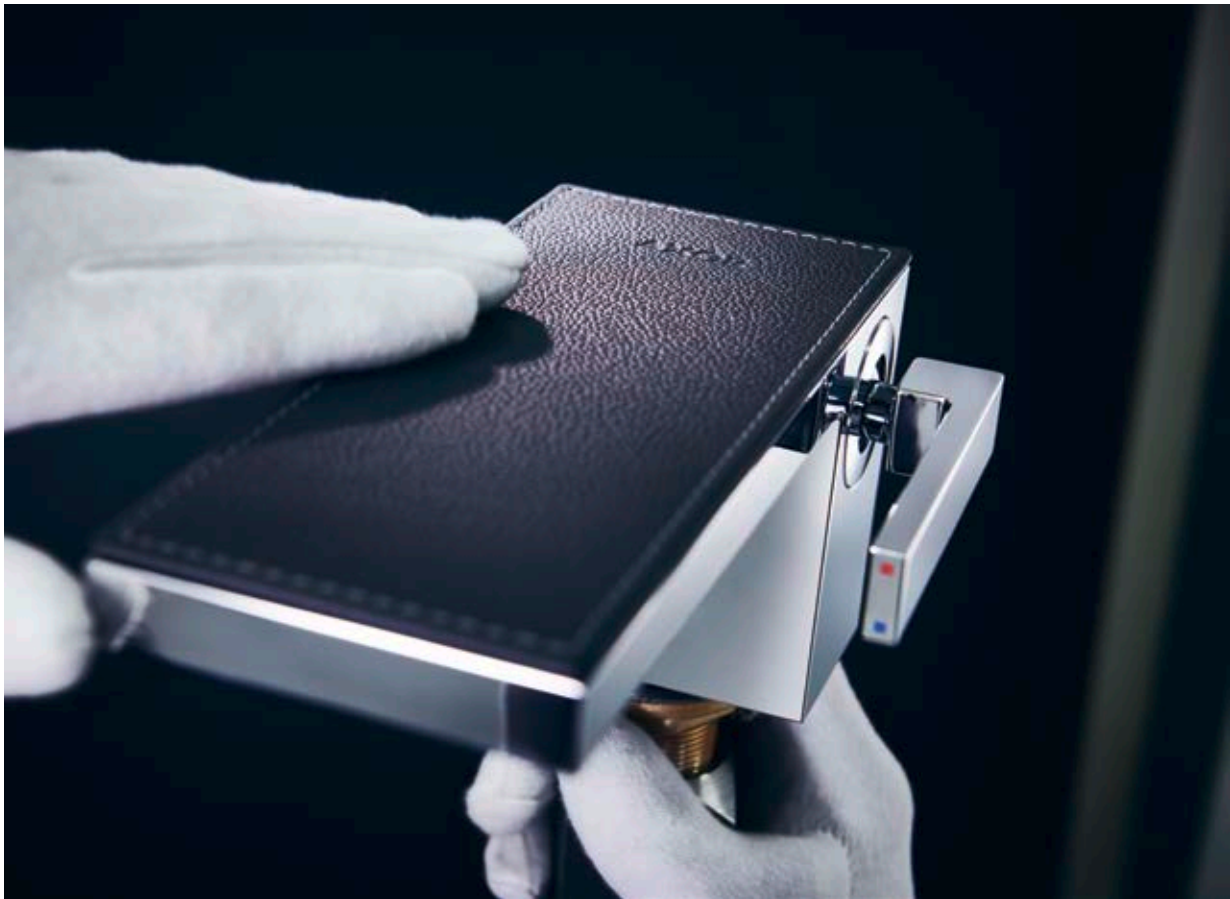

Natural materials for the bathroom – each cover plate is one of a kind

The refined materials reveal themselves in unique ways in AXOR MyEdition cover plates. Each design version is developed in an intensive process, made with precision craftsmanship and tested under the harshest conditions for mixer use in internal fatigue testing. The result is a perfect whole.

The elegant walnut veneer provides a fascinating example. Delicate sheets of wood are used to produce sturdy components with an attractive surface pattern, strikingly brown in color with a striped grain.

The white Lasa marble from South Tyrol is characterized by its fine, gold veins. The cover plates are shaved from the marble block in extremely thin layers, which are meticulously processed to produce stone veneer with a perfect surface feel.

Its dark counterpart, Nero Marquina, comes from quarries in the Basque Country of northern Spain. Deep black, with a distinctive white veining, it evokes the ultimate in **elegance**.

Just as meticulous is the selection of nappa leather of European origin. Due to precision processing, it is especially resilient, so it is also suitable for use in wet areas.

Each cover plate is one of a kind. This makes each AXOR MyEdition mixer into an unmistakable **original**. For the ultimate in **individualization** for wash basins and bathtubs.

To ensure the durability of the cover plates, individual cleaning recommendations are enclosed for each material.

Consistent design language – for mixer and spray



New spray formers:
The shape of the water spray is derived from the product design. In this case, a rectangular spray former was developed which, in a fixed position, is equipped with PowderRain spray mode as well as QuickClean function for easily removing calcium deposits.



PowderRain spray mode:
AXOR MyEdition is the first collection with the PowderRain spray mode. Satiny smooth droplets emerge from 170 of the finest spray nozzles for a sensual, soft and luxuriant spray experience.



Isolated water conduction:
A separated water conduction is integrated into the metal basic set which separates the conduit from the body so it remains free of lead and nickel concentrations.

Wash basin



Single lever basin mixer 70 with push-open waste set # 47010, -000, -600



Single lever basin mixer 70 with push-open waste set without plate # 47012, -000, -xxx



/ For combination with plate 200



Single lever basin mixer 230 with push-open waste set # 47020, -000, -600



Single lever basin mixer 230 with push-open waste set without plate # 47022, -000, -xxx



/ For combination with plate 245



3-hole basin mixer 70 with push-open waste set # 47050, -000, -600



3-hole basin mixer 70 with push-open waste set without plate # 47052, -000, -xxx



/ For combination with plate 200



Single lever basin mixer for concealed installation wall-mounted with spout 221 mm # 47060, -000, -600



Single lever basin mixer for concealed installation wall-mounted with spout 221 mm without plate # 47062, -000, -xxx



/ For combination with plate 245

Single lever basin mixer floor-standing with push-open waste set # 47040, -000, -600



Single lever basin mixer floor-standing with push-open waste set without plate # 47042, -000, -xxx



/ For combination with plate 245

Individualization for the bathtub



The individualization concept of AXOR MyEdition can also be applied to bathtubs.

The black Nero Marquina Marble cover plate with its striking white veining is a distinctive highlight on the four-hole rim-mounted mixer.

Especially impressive as well is the white Lasa Covelano Vena Oro Marble cover plate in combination with the floor-standing bathtub mixer.

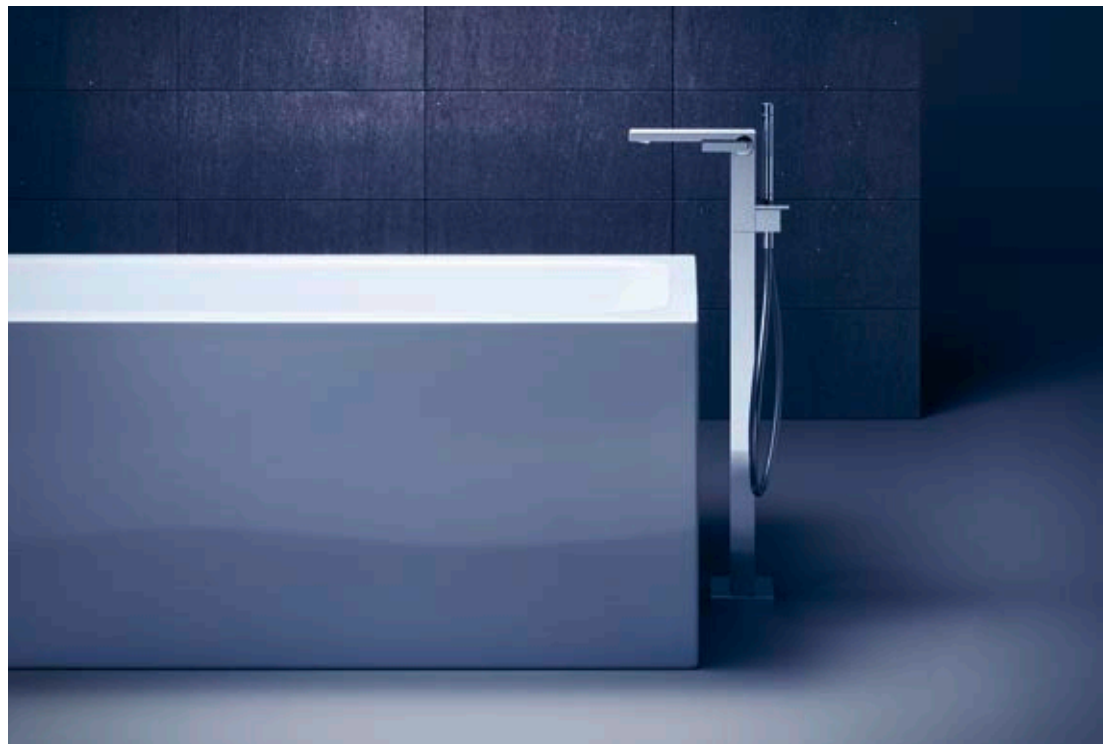

Bidet



Single lever bidet mixer
with push-open waste set
47210, -000, -600



Single lever bidet mixer
with push-open waste set
without plate
47212, -000, -xxx



/ For combination with plate 150

Bathtub



4-hole rim mounted bath mixer
47430, -000, -600



4-hole rim mounted bath mixer
without plate
47432, -000, -xxx



/ For combination with plate 200



Bath spout
47410, -000, -600



Bath spout without plate
47412, -000, -xxx



/ For combination with plate 200



Single lever bath mixer
floor-standing
47440, -000, -600

Basic set
10452180



Single lever bath mixer
floor-standing without plate
47442, -000, -xxx

Basic set
10452180



/ For combination with plate 245



Finish set square
28012, -000, -xxx

Finish set oval (not shown)
28022, -000, -xxx

Basic set
15490180

- / sBox for quiet, smooth and safe hose guiding
- / Suitable for rim- or tile-mounted installation
- / Bath rim width at least 100 mm
- / Maximum pull-out length of individually selectable hand shower: 1.45 m



Available as standard for AXOR MyEdition are the variants Chrome/ Mirror Glass (-000) and Chrome/Black Glass (-600). Glass is particularly hygienic, sturdy and resistant to harsh cleaning agents.



The cover plate in natural Black Walnut has very fine dark brown coloring in various shades. In combination with the AXOR FinishPlus surface Brushed Black Chrome (available exclusively for AXOR MyEdition), it's a real eye-catcher.

52



The brilliantly white Lasa Covelano Vena Oro Marble is fascinating with its fine, golden veining. It is sourced from a quarry in the Jenn Cliff Massif, the highest quarry in Europe, at an elevation of more than 2,220 meters.



The black Nero Marquina Marble is an exquisite, black limestone with distinctive, white quartz veining. Because it can be polished, it is called marble. The white quartz veins were formed in the later stages of the rock's development.



European Nappa Leather brings a sense of coziness to the bathroom. The gray leather has a fine, natural structure and a soft, smooth feel.

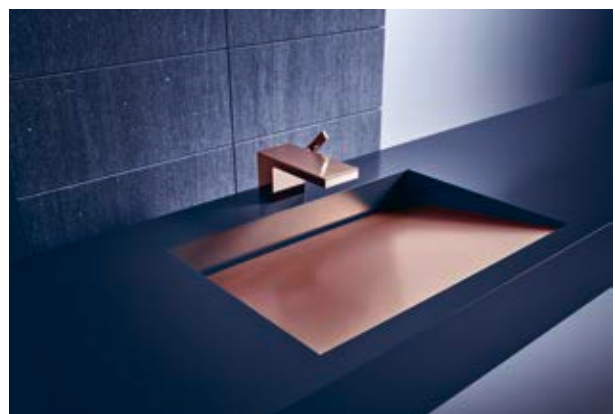

AXOR FinishPlus surfaces bring color into the bathroom. In addition to color-in-color combinations with polished or hand-brushed variants, bi-color variants can also be realized simply by exchanging the body and top.

Cover plate materials



Mirror Glass
plate 200
47900000

Plate 245 (not shown)
47901000

Plate 150 (not shown)
47902000



Black Glass
plate 200
47900000

Plate 245 (not shown)
47901000

Plate 150 (not shown)
47902000



Black Walnut
plate 200
47906000

Plate 245 (not shown)
47907000

Plate 150 (not shown)
47908000



Marble Lasa Covelano Vena Oro
plate 200
47909000

Plate 245 (not shown)
47910000

Plate 150 (not shown)
47911000



Marble Nero Marquina
plate 200
47913000

Plate 245 (not shown)
47914000

Plate 150 (not shown)
47915000



Leather
plate 200
47916000

Plate 245 (not shown)
47917000

Plate 150 (not shown)
47918000



Metal
plate 200
47903000

Plate 245 (not shown)
47904000

Plate 150 (not shown)
47905000

53



Mounting plate 200
47921000

Mounting plate 245 (not shown)
47922000

Mounting plate 150 (not shown)
47923000

/ Using the carrier plate, a custom material can be applied to the AXOR MyEdition products without a plate.















Template 200
47925000





/ The corresponding AXOR MyEdition template, which can be used multiple times, is required for exact positioning of the individual material on the carrier plate.



Collection overview and combination options

			Product cover plates											
														
			Mirror Glass			Black Glass			Chrome			15 PVD surface finishes		
			Plate 200	Plate 245	Plate 150	Plate 200	Plate 245	Plate 150	Plate 200	Plate 245	Plate 150	Plate 200	Plate 245	Plate 150
	Single lever basin mixer 70	Standard Chrome products	47010000			47010600								
	Single lever basin mixer 70 without plate	Chrome	47012000 47900000			47012000 47900600			47012000 47903000			47012000 47903XXX		
		15 PVD surface finishes	47012XXX 47900000			47012XXX 47900600			47012XXX 47903000			47012XXX 47903XXX		
	Single lever basin mixer 230	Standard Chrome products		47020000			47020600							
	Single lever basin mixer 230 without plate	Chrome		47022000 47901000			47022000 47901600			47022000 47904000			47022000 47904XXX	
		15 PVD surface finishes		47022XXX 47901000			47022XXX 47901600			47022XXX 47904000			47022XXX 47904XXX	
	3-hole basin mixer 70	Standard Chrome products	47050000			47050600								
	3-hole basin mixer 70 without plate	Chrome	47052000 47900000			47052000 47900600			47052000 47903000			47052000 47903XXX		
		15 PVD surface finishes	47052XXX 47900000			47052XXX 47900600			47052XXX 47903000			47052XXX 47903XXX		
	Single lever basin mixer for concealed installation	Standard Chrome products		47060000			47060600							
	Single lever basin mixer for concealed installation without plate	Chrome		47062000 47901000			47062000 47901600			47062000 47904000			47062000 47904XXX	
		15 PVD surface finishes		47062XXX 47901000			47062XXX 47901600			47062XXX 47904000			47062XXX 47904XXX	
	Single lever basin mixer floor-standing	Standard Chrome products		47040000			47040600							
	Single lever basin mixer floor-standing without plate	Chrome		47042000 47901000			47042000 47901600			47042000 47904000			47042000 47904XXX	
		15 PVD surface finishes		47042XXX 47901000			47042XXX 47901600			47042XXX 47904000			47042XXX 47904XXX	
	Single lever bidet mixer	Standard Chrome products			47210000			47210600						
	Single lever bidet mixer without plate	Chrome		47212000 47902000			47212000 47902600			47212000 47905000			47212000 47905XXX	
		15 PVD surface finishes		47212XXX 47902000			47212XXX 47902600			47212XXX 47905000			47212XXX 47905XXX	
	4-hole rim mounted bath mixer	Standard Chrome products	47430000			47430600								
	4-hole rim mounted bath mixer without plate	Chrome	47432000 47900000			47432000 47900600			47432000 47903000			47432000 47903XXX		
		15 PVD surface finishes	47432XXX 47900000			47432XXX 47900600			47432XXX 47903000			47432XXX 47903XXX		
	Single lever bath mixer floor-standing	Standard Chrome products		47440000			47440600							
	Single lever bath mixer floor-standing without plate	Chrome		47442000 47901000			47442000 47901600			47442000 47904000			47442000 47904XXX	
		15 PVD surface finishes		47442XXX 47901000			47442XXX 47901600			47442XXX 47904000			47442XXX 47904XXX	
	Bath spout	Standard Chrome products	47410000			47410600								
	Bath spout without plate	Chrome	47412000 47900000			47412000 47900600			47412000 47903000			47412000 47903XXX		
		15 PVD surface finishes	47412XXX 47900000			47412XXX 47900600			47412XXX 47903000			47412XXX 47903XXX		

*For exact positioning of the individual material on the AXOR MyEdition support plate, the corresponding template is required as an optional accessory.

Product cover plates														
														
Wood: Black Walnut			White Marble: Lasa Covelano Vena Oro			Black Marble: Nero Marquina			Leather: Gray Nappa Leather			Carrier plate for custom material		
Plate 200	Plate 245	Plate 150	Plate 200	Plate 245	Plate 150	Plate 200	Plate 245	Plate 150	Plate 200	Plate 245	Plate 150	Plate 200	Plate 245	Plate 150
47012000 47906000			47012000 47909000			47012000 47913000			47012000 47916000			47012000 47921000*		
47012XXX 47906000			47012XXX 47909000			47012XXX 47913000			47012XXX 47916000			47012XXX 47921000*		
	47022000 47907000			47022000 47910000			47022000 47914000			47022000 47917000			47022000 47922000*	
	47022XXX 47907000			47022XXX 47910000			47022XXX 47914000			47022XXX 47917000			47022XXX 47922000*	
47052000 47906000			47052000 47909000			47052000 47913000			47052000 47916000			47052000 47921000*		
47052XXX 47906000			47052XXX 47909000			47052XXX 47913000			47052XXX 47916000			47052XXX 47921000*		
	47062000 47907000			47062000 47910000			47062000 47914000			47062000 47917000			47062000 47922000*	
	47062XXX 47907000			47062XXX 47910000			47062XXX 47914000			47062XXX 47917000			47062XXX 47922000*	
	47042000 47907000			47042000 47910000			47042000 47914000			47042000 47917000			47042000 47922000*	
	47042XXX 47907000			47042XXX 47910000			47042XXX 47914000			47042XXX 47917000			47042XXX 47922000*	
		47212000 47908000			47212000 47911000			47212000 47915000			47212000 47918000			47212000 47923000*
		47212XXX 47908000			47212XXX 47911000			47212XXX 47915000			47212XXX 47918000			47212XXX 47923000*
47432000 47906000			47432000 47909000			47432000 47913000			47432000 47916000			47432000 47921000*		
47432XXX 47906000			47432XXX 47909000			47432XXX 47913000			47432XXX 47916000			47432XXX 47921000*		
	47442000 47907000			47442000 47910000			47442000 47914000			47442000 47917000			47442000 47922000*	
	47442XXX 47907000			47442XXX 47910000			47442XXX 47914000			47442XXX 47917000			47442XXX 47922000*	
47412000 47906000			47412000 47909000			47412000 47913000			47412000 47916000			47412000 47921000*		
47412XXX 47906000			47412XXX 47909000			47412XXX 47913000			47412XXX 47916000			47412XXX 47921000*		



“THE IDEA WITH AXOR STARCK WAS TO MAKE A DESIGN THAT WAS DEEPLY, STRUCTURALLY RESPECTFUL OF WATER. THE FIRST THING TO BRING WATER IN HISTORY WAS THE PUMP, AND SO THE IDEA WAS TO MAKE SOMETHING AS SIMPLE AS THIS.”

Philippe Starck

AXOR Starck

Minimalist bathroom design

AXOR Starck embodies the **aesthetic** of **minimalism**. The design focuses on the essential. A familiar shape, uncompromising in function, with an elemental connection to water. And therefore, an **archetype**: The collection is inspired by the historic hand pump used to pump water from wells.

Design: Philippe Starck

57

CHARACTERISTIC DESIGN FEATURE:

Rigorously cylindrical with a diagonal spout.

THE DESIGNER'S IDEA:

A **minimalist** statement: The basic form is derived from the historical hand pump – the first and most elementary object that made water available. Everything here has to do with the pure water and its beauty.

SPECIAL COLLECTION HIGHLIGHTS:

- / Three handle variants: the **classic** feather handle, the **modern** pin handle and the **ergonomic** lever handle
- / Mixers in various ComfortZones that can be combined with various wash basins
- / AXOR Starck has been a bestseller for 25 years and is now a **design classic**
- / Innovative baton hand shower: the first of its kind and now a **classic**

Learn more about AXOR Starck:
axor-design.com

Three single lever mixers – three handle variants

Three handles, one design: from the classic feather handle – the **original** from 1994 and a **classic** today – to the modern, totally streamlined pin handle and the ergonomic lever handle. The iconic, diagonal spout shape and the minimalist design underscore the focus on the essentials.



AXOR STARCK SINGLE LEVER WASH BASIN MIXER WITH LEVER HANDLE
 / Lever handle: The ergonomic lever handle represents modern minimalism
 / Available in three heights: 80, 100, 250
 / A CoolStart variant for saving energy and water is available

AXOR STARCK SINGLE LEVER WASH BASIN MIXER WITH PIN HANDLE

- / Pin handle with integrated joystick cartridge: The sophisticated handle completes the minimalist design
- / Integrated cartridge enables a slim body
- / Three simple cylinders engender the minimalist design
- / Available in four heights: 70, 90, 170, 250

AXOR STARCK SINGLE LEVER WASH BASIN MIXER WITH FEATHER HANDLE

- / Feather handle: classic form with a wink. The feather is a surprising detail within the overall minimalist look
- / Available in three heights: 60, 70, 220
- / Original design from 1994: inspired by the hand pump

Wash basin



Single lever basin mixer 70
with pin handle for hand wash basins
with pop-up waste set
10116, -000, -xxx



Single lever basin mixer 90
with pin handle and pop-up waste set
10111, -000, -xxx
with waste set (not shown)
10117, -000, -xxx



Single lever basin mixer 170
with pin handle and waste set
10123, -000, -xxx



Single lever basin mixer 250
with pin handle for wash bowls
with waste set
10129, -000, -xxx



Single lever basin mixer 70
with pop-up waste set
10010, -000, -xxx
with waste set (not shown)
10018, -000, -xxx



Single lever basin mixer 80
with lever handle for hand wash
basins with pop-up waste set
10102, -000, -xxx



Single lever basin mixer 100
with lever handle
and pop-up waste set
10001, -000, -xxx
with waste set (not shown)
10003, -000, -xxx
with CoolStart (not shown)
10007, -000, -xxx



Single lever basin mixer 250
with lever handle for wash bowls
with waste set
10103, -000, -xxx



2-handle basin mixer 80
with pop-up waste set
10030, -000, -xxx



Pillar tap 70 without waste set
38130, -000, -xxx



Electronic



Electronic basin mixer
with temperature control
battery-operated
10101, -000, -340

with temperature pre-adjustment
battery-operated (not shown)
10106, -000, -340



Electronic basin mixer
with temperature control
with 230 V mains connection
10140, -000, -xxx

with temperature pre-adjustment
with mains connection 230 V
(not shown)
10145, -000, -xxx



Bidet



Single lever bidet mixer
with pin handle and pop-up waste set
10211, -000, -xxx



Single lever bidet mixer
with lever handle
and pop-up waste set
10214, -000, -xxx



Single lever basin mixer 90
with bidette hand shower
and shower hose 1.60 m
10300, -000, -xxx





A luxurious shower experience for indoors and outdoors with the AXOR Starck shower column

The **minimalist** in the shower. Uncompromisingly streamlined, the shapes come together to form a unique whole: a circle. A cylinder. A rod. The result is a one-of-a-kind shower column – now also for outdoor use.

AXOR OVERHEAD SHOWER 240 1JET

- / High-quality metal disc with generous diameter (240 mm)
- / Enveloping PowderRain spray
- / With user-friendly QuickClean cleaning function

- / Indoor version: Thermostat with scalding protection at 40 °C
- / Outdoor version: MR32 mixing cartridge for temperature control

- / Switching between overhead and hand showers and integrated volume control

AXOR BATON HAND SHOWER 2JET

- / A **classic** in **design** and function. The baton hand shower sets the for innovative control: simple rotation allows users to switch between the soft Rain spray and the powerful Mono spray
- / Positioned in a high-quality metal holder

- / Indoor version: Basic set (#10902180) for the shower column positioned behind the wall flange
- / Outdoor version: Adapter set for quick and easy installation and removal, as well as for fast draining to keep from freezing in the winter – included in delivery

- / The shower column pipe makes it seem as if the water is coming directly out of the floor



Shower

NEW



Shower column with hand shower
12672, -000, -670, -xxx

Basic set
10902180



Nature shower column
with hand shower (not shown)
12670, -670, -xxx



Nature shower column (not shown)
12671, -670, -xxx



Extension set 80 mm
13608000 160.00 €

Cover for water supply
12675000 200.00 €

/ The Matt Black surface and the AXOR FinishPlus PVD surface finishes are weather-resistant and suitable for outdoor use



Single lever shower mixer
for exposed installation
with pin handle
10611, -000, -xxx



Single lever shower mixer
for exposed installation
with lever handle
10665, -000, -XXX



Single lever shower mixer
for concealed installation
with pin handle
10616, -000, -xxx

Basic set iBox universal
01700180

/ Matching handle version for chosen basin mixer version available



Single lever shower mixer
for concealed installation
with lever handle
10614, -000, -xxx

Basic set iBox universal
01700180

/ Matching handle version
for chosen basin mixer
version available



Thermostat HighFlow
for concealed installation
10715, -000, -xxx

Thermostat for concealed installation
(not shown)
10710, -000, -xxx

Basic set iBox universal
01700180



Thermostat for concealed installation
with shut-off valve
10700, -000, -xxx

Basic set iBox universal
01700180



Thermostat for concealed installation
with shut-off/diverter valve
10720, -000, -xxx

Basic set iBox universal
01700180



Shut-off valve
for concealed installation
10970, -000, -xxx

Basic set 52 l/min spindle
16973180

Basic set 40 l/min ceramic
16974180

Basic set 130 l/min spindle
16970180



Shut-off/diverter valve Trio/Quattro
for concealed installation
10930, -000, -xxx

Basic set Trio
16982180

Basic set Quattro
16930180



Shower



Plate overhead shower 240 1jet
28494, -000, -xxx



Shower set 0.90 m
with baton hand shower 2jet
27980, -000, -xxx



with baton hand shower 1jet
(not shown)
27983, -000, -xxx



Shower bar 0.90 m
27830, -000, -xxx



Porter unit 120/120
with baton hand shower 2jet
and shower hose
12626, -000, -xxx



Baton hand shower 2jet
28532, -000, -670, -xxx



Baton hand shower 1jet (not shown)
10531, -000, -xxx



/ Change of spray modes by simply turning the spray disc at the top of the baton hand shower

- Optional parts:
- / Metal effect shower hose 1.25 m (# 28282, -000, -xxx)
 - / Meta leffect shower hose 1.60 m (# 28286, -000, -xxx)
 - / Metal effect shower hose 2.00 m (# 28284, -000, -xxx)



In addition to the AXOR Starck 240 1jet overhead shower, other matching products for the shower can be found in the Showers chapter starting on page 150.

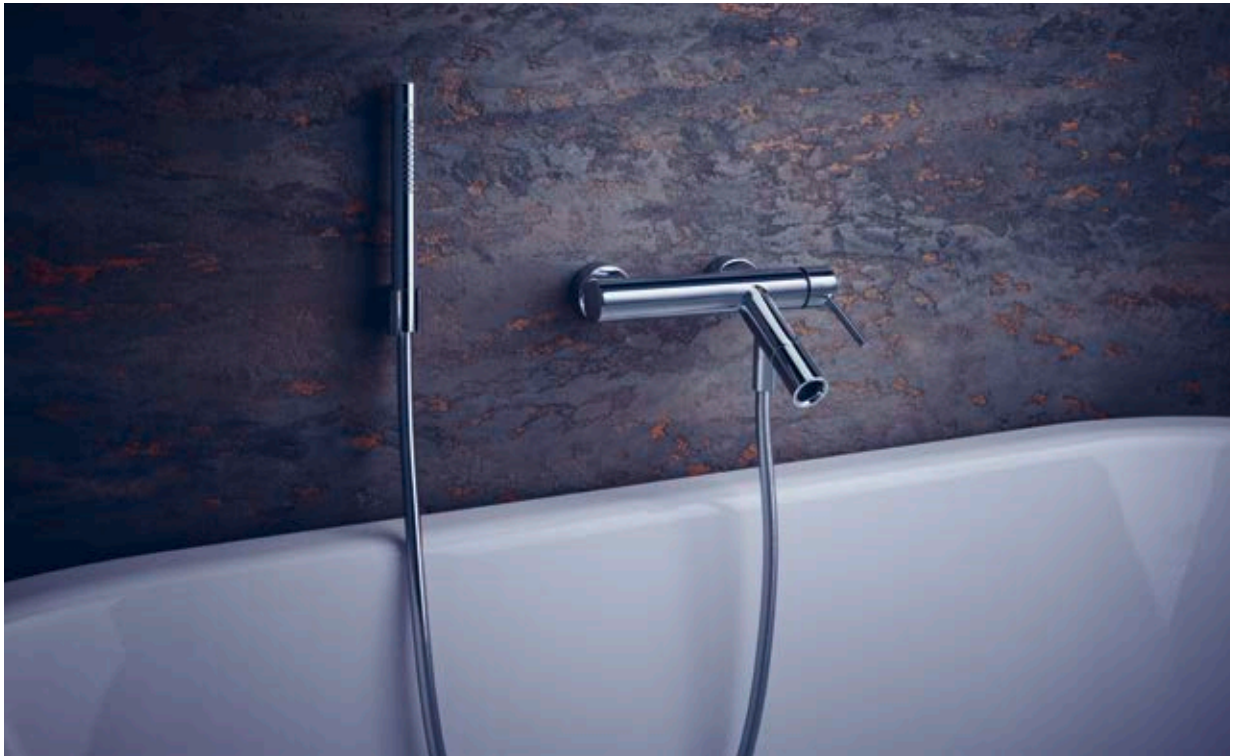

Minimalist look for the bathtub

66

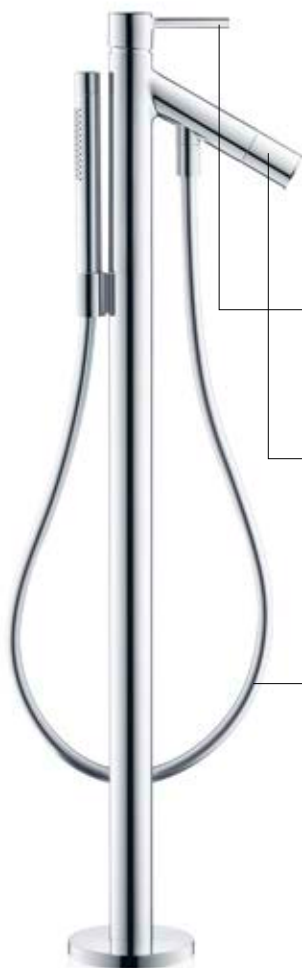

An icon for your bathtub: Clear, linear forms with a diagonal spout that recalls the historical hand pump. The floor-standing bathtub mixer is particularly suitable for free-standing bathtubs.

VARIOUS HANDLE VARIANTS

/ Available with various handle variants to match the selected wash basin mixer

SWITCHING OUTLETS

/ Switching from bathtub mixer to hand shower is done at the bath spout
/ Flow rate: 22 l/min (at 3 bar)

METAL EFFECT SHOWER HOSE 1.25 M (# 28282000)
AND BATON HAND SHOWER 2JET (# 28532000)

/ Included in scope of delivery



Single lever bath mixer for exposed installation with pin handle
10411, -000, -xxx

with lever handle (not shown)
10465, -000, -xxx



Bath spout
10410, -000, -xxx



/ 50 mm extension for bath spout available (# 10495, -000, -xxx)



4-hole rim mounted bath mixer with zero handles
10444, -000, -xxx

Basic set
15480180



/ Incl. hand shower 120 3jet (# 26050, -000, -xxx)



4-hole tile mounted bath mixer with zero handles
10451, -000, -xxx

Basic set
15481180



Single lever bath mixer for concealed installation with pin handle
10416, -000, -xxx

with integrated security combination according to EN1717 (not shown)
10418, -000, -xxx

Basic set iBox universal
01700180

/ This product is available in the surface finish Polished Gold Optic only via AXOR Signature inquiry



Single lever bath mixer for concealed installation with lever handle
10414, -000, -xxx

with integrated security combination according to EN1717 (not shown)
10427, -000, -xxx

Basic set iBox universal
01700180



Single lever bath mixer floor-standing with pin handle
10456, -000, -xxx

with lever handle (not shown)
10455, -000, -xxx

Basic set
10452180



/ Incl. baton hand shower 2jet (# 28532, -000, -xxx) and metal effect shower hose 1.25 m (# 28282, -000, -xxx)

Optional parts:
/ Extension 60 mm for spout (# 10981, -000, -xxx)



2-hole rim mounted thermostatic bath mixer with zero handles
10480, -000, -xxx

Basic set
15486180

/ Combinable with sBox finish set for bathtubs in oval design (# 28022, -000, -xxx) for quiet, smooth and safe hose guidance



AXOR Starck V

The vitality of water

AXOR Starck V is a unique eye-catcher at the wash basin. With its **organic, sculptural design**, the spectacular glass body displays the water, revealing a wonder of nature: the water vortex. In all its strength and beauty. Vital and captivating.

Design: Philippe Starck

“AXOR STARCK V IS A REVOLUTION: A MINIMAL OBJECT, NEARLY INVISIBLE AND TOTALLY TRANSPARENT, THAT ENCLOSES THE WATER VORTEX. THIS ENABLES A SPECIAL EXPERIENCE WITH WATER.”

Philippe Starck

CHARACTERISTIC DESIGN FEATURE:

A fascinating eye-catcher: The organic, sculptural form with a body in transparent glass, making the powerful, specially designed water vortex visible.

THE DESIGNER'S IDEA:

Making the beauty and vitality of water visible by means of a glass body.

SPECIAL COLLECTION HIGHLIGHTS:

- / Three variants: Single lever mixer 140 and 220 with a higher base or with a two-hole mixer with a separate pin handle
- / Two additional glass cuts: Diamond or facet cut – **classic** or **modern**
- / With EasyClick and SafetyStop function: The spout can be separated from the base with just a click in order to clean or replace it
- / Convenient 360° swivel spout
- / Spout made of high-quality crystal glass
- / Economical water consumption: 4 l/min (at 3 bar)
- / AXOR Starck V is the fifth collection designed in cooperation with Philippe Starck

Understanding the beauty and soul of water

Unrelenting curiosity and a boundless passion for water are what motivate Klaus Grohe, son of the company's founder, Hans Grohe. He is particularly impressed by the pure energy of a vortex. He wonders how to bring this natural spectacle home, to the wash basin, and starts to develop a water vortex in a mixer. Klaus Grohe and AXOR find a partner in designer Philippe Starck, who creates a glass mixer, a kind of organic sculpture, in which this power of nature can be seen.

In a way that, up to now, was not possible, AXOR Starck V lets us experience the elemental fascination of water. The transparent glass body enables us to see the **elegance** and vitality of a water vortex.

70

GLASS SPOUT

The crystal glass spout enables users to see an extraordinary water spectacle, the vortex.

For even more **individualization**, there are different variants of the glass spout:

/ Diamond-cut

/ Bevel-cut

PRODUCT VARIANTS

The single lever wash basin mixer, two-hole wash basin mixer and single lever mixer variant for wash bowls all are suitable for a variety of applications



INDIVIDUALIZATION

The base can be individualized with the exclusive AXOR FinishPlus surfaces

Wash basin



Single lever basin mixer 140
with glass spout and waste set
12112, -000, -xxx



Single lever basin mixer 140
with glass spout and waste set
12112450



/ Color version with white
socket (-450)



Single lever basin mixer 220
with glass spout for wash bowls
with waste set
12114, -000, -xxx



/ Suitable for free-standing
wash bowls due to the high
position of the handle



2-hole basin mixer 110
with waste set
12115, -000, -xxx



/ Handle can be positioned on
the right or left or at any position
on or around the wash basin



Single lever basin mixer 140
with glass spout and waste set -
diamond cut
12122, -000, -xxx



Single lever basin mixer 140
with glass spout and waste set -
diamond cut
12122990



Single lever basin mixer 140
with glass spout and waste set -
bevel cut
12123, -000, -xxx



Single lever basin mixer 140
with glass spout and waste set -
bevel cut
12123990



True beauty lies in the details

72



SWIVEL SPOUT
For optimum water spray alignment and more flexibility in installation

REMOVABLE SPOUT
Makes it easy to empty when not in use and to clean in the dishwasher

INTENSITY CONTROL
To adapt perfectly to local water pressure conditions, the intensity of the water vortex can be adjusted with the Allen key included with delivery



SAFETYSTOP FUNCTION
Closes the water valve when removing the body

EASYCLICK
Makes it easy to remove the glass body

LOW WATER CONSUMPTION
Flow rate limited to 4 l/min (at 3 bar)

JOYSTICK CARTRIDGE
The handle can be positioned to the left or right, depending on the user's preferences



Water can be breathtakingly beautiful.
When it forms an elegant vortex, it
becomes a true natural spectacle.





AXOR Starck Organic

Sense and sensibility

Modeled on nature. In its beauty, efficiency and primeval essence. AXOR Starck Organic unifies **design** and **technology** into a **sculptural** appearance with sensuous, organic forms. **Minimalist** in water design and in its use of resources. As nature would have intended.

Design: Philippe Starck

“NATURE LOVES
ECONOMY. THAT’S
WHY THE AXOR STARCK
ORGANIC COLLECTION
LOOKS SO REDUCED, YET
IS FULL OF INVENTION.
IT IS REVOLUTIONARY.”

Philippe Starck

CHARACTERISTIC DESIGN FEATURE:

Organic, minimalist bathroom design: The mixer, inspired by the primeval essence of nature, refers to forms such as a branch or a water droplet.

THE DESIGNER’S IDEA:

A revolutionary way of dealing with the vital element of water: AXOR Starck Organic brings ecology and economy together in one collection. In an organic, composition with a **sensual** water experience.

SPECIAL COLLECTION HIGHLIGHTS:

- / Innovative control concept: Separate control of water flow and temperature
- / AXOR wash basin mixer with water consumption of just 3.5 l/min (at 3 bar)
- / Innovative shower spray for a mixer: a sensual water experience with a soft, luxuriant stream of water and low consumption
- / Intelligent use of resources with respect to energy and materials
- / AXOR Starck Organic is the fourth collection designed in cooperation with Philippe Starck
- / Distinguished with the Green Product Design Award

An innovative concept for conscientiously controlling water flow and temperature

The innovative, two-handle mixer from AXOR Starck Organic is the next step in the evolution in mixer control. It moves away from the classic single lever mixers with which water temperature and flow are controlled simultaneously. Instead the mixer ensures an **ergonomic** motion sequence with economical water use: The temperature controller, used less frequently, is positioned on the mixer head; the handle for water flow control, always in use, is in a practical position below at the water spout.



ADVANTAGES OF SEPARATE CONTROLS

TEMPERATURE CONTROL

- / Preset to a preferred temperature or an energy-saving cold setting
- / A **harmonious** look in any position
- / The preset prevents dripping and dirt marks because the mixer handle rarely needs to be touched
- / New vivid, easy-to-see hot and cold labeling: cold water = green (energy-saving); hot water = orange

WATER FLOW CONTROL

- / Cleaner and more convenient, with direct operation at the spout
- / Normal position for 3.5 l/min: best functionality together with a consistent, pleasant water flow while still saving water
- / Booster position for increasing flow rate to 5 l/min
- / Gradual water flow control with snap-in positions at 3.5 l/min (Normal) and 5 l/min (Booster)

Intelligent functions set ecological and technological standards

MIXER SHOWER SPRAY

The innovative shower spray for the wash basin mixer sets new standards for *sensuality* and conservation. It generates a wonderful water flow with a pleasant feel while maintaining optimum function. With 90 small openings the spray former creates a soft, luxuriant shower spray.



NORMAL + BOOSTER

Gradual water flow control up to the snap-in position for 3.5 l/min. Those who need a larger volume of water can simply switch to the Booster position (5 l/min).



SPRAY FORMER

The spray former has a QuickClean function for easily removing limescale deposits. For a conventional spray jet, simply replace the spray former.

ADJUSTABLE SPOUT

For the right-handed version, the spout is used in the ex-works position. Left-handed users can rotate the spout by 80° for perfect *ergonomics*. Simply unscrew the jet former with the appropriate key and reinsert the spout.

Revolutionary water experience. Low water consumption

AXOR Starck Organic minimizes the consumption of both water, a valuable **natural** resource, and energy. With the temperature preset, less hot water is used. During production of the collection, resources are used sparingly: The hollow body construction of the mixer requires less material and, as a result, less.

SETTING THE TEMPERATURE CONSCIOUSLY

The temperature can be set individually. A maximum temperature can be set to save energy costs and prevent scalding. This is interesting primarily for mixers used in public areas and hotels as well as in households with children

MINIMIZED MATERIAL USE

About one third less brass is used in the mixer walls (hollow bodies) than in conventional manufacturing

ISOLATED WATER CONDUCTION

Prevents direct water contact with the mixer body. This keeps drinking water free of lead and nickel concentrations

ECONOMICAL WATER CONSUMPTION

Flow rate limited to 3.5 l/min. The result is a consistent, pleasant water experience with improved functionality in comparison with conventional mixers

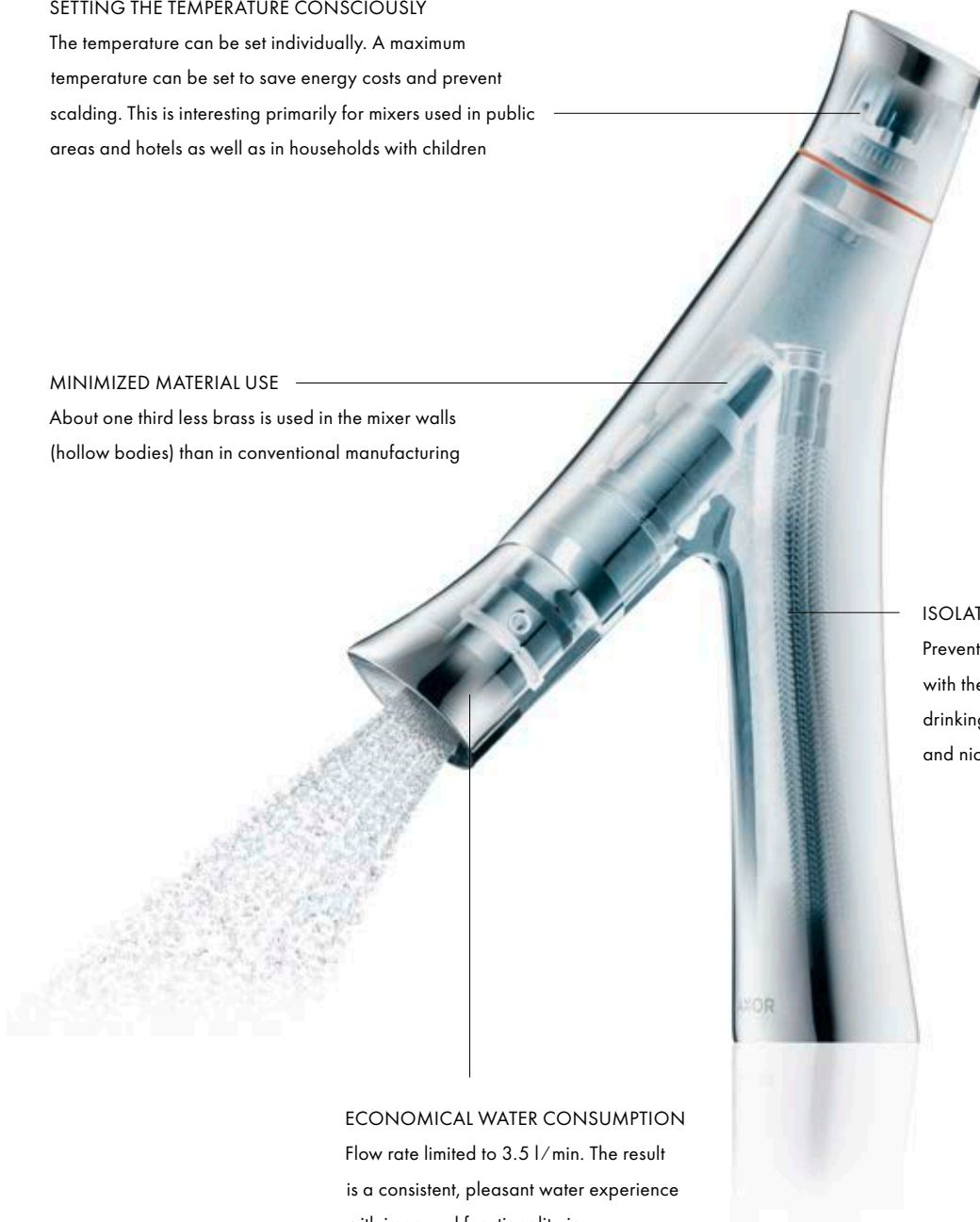

Wash basin



2-handle basin mixer 80
with pop-up waste set
12010, -000, -xxx
with waste set (not shown)
12011, -000, -xxx



2-handle basin mixer 170
for wash bowls with waste set
12012, -000, -xxx



2-handle basin mixer 240
for wash bowls with waste set
12013, -000, -xxx



2-handle basin mixer 50
for hand wash basins
with pop-up waste set
12014, -000, -xxx



Pillar tap 50 without waste set
12110, -000, -xxx



2-handle basin mixer
for concealed installation
wall-mounted with spout 187 mm
12015, -000, -xxx

Basic set
10902180



The perfect symbiosis in the shower: organic and geometric

AXOR Starck Organic can be installed as desired, either with the classic iBox universal basic set or with the concealed installation of the AXOR ShowerCollection. The 120/120 mm modules are the perfect match, for example, with the 350 1jet overhead shower with PowderRain.



Shower



Shower thermostat for exposed installation
12602, -000, -xxx



Single lever shower mixer for concealed installation
12605, -000, -xxx
Basic set iBox universal
01700180



Thermostat HighFlow for concealed installation
12711000
Basic set iBox universal
01700180



Thermostat for concealed installation with shut-off valve
12715, -000, -xxx
Basic set iBox universal
01700180



Thermostat for concealed installation with shut-off/diverter valve
12716, -000, -xxx
Basic set iBox universal
01700180



Thermostat HighFlow 120/120 for concealed installation
12712, -000, -xxx
Basic set
10754180



Shut-off valve 120/120 for concealed installation
12771, -000, -xxx
Basic set
10971180



Shut-off/diverter valve Trio/Quattro 120/120 for concealed installation
12731, -000, -xxx
Basic set for Trio 120/120
36770180
Basic set Trio
16982180
Basic set Quattro
16930180



Thermostatic module 360/120 for concealed installation
12717, -000, -xxx

/ Vertical or horizontal installation for individual shower solutions possible



Porter unit 120/120 with baton hand shower 2jet and shower hose
12232, -000, -xxx



Shower set 0.90 m with baton hand shower 2jet
12231, -000, -xxx



Shower bar 0.90 m (not shown)
27830, -000, -xxx



Baton hand shower 2jet
12680, -000, -xxx



/ Hand shower in organic design available, matching the AXOR Starck Organic collection

- Optional parts:
- / Metal effect shower hose, 1.25 m (#28282, -000, -xxx)
 - / Metal effect shower hose, 1.60 m (#28286, -000, -xxx)
 - / Metal effect shower hose, 2.00 m (#28284, -000, -xxx)



82

Organic design all the way to the bathtub

The striking, powerful AXOR Starck Organic design is also found in the extraordinary bath mixers. The floor-standing bath filler with integrated hand shower complements the range for free-standing bathtubs. Thanks to its organic, minimalist design, it looks great with the broadest range of bathtub shapes.



Bath thermostat floor-standing
12016, -000, -xxx

Basic set
10452180



/ Incl. baton hand shower 2jet
(# 28532000) and Metal effect
shower hose 1.25 m
(# 28282000)

Bathtub



Bath thermostat
for exposed installation
12410, -000, -xxx



Single lever bath mixer
for concealed installation
12415000

with integrated security combination
according to EN1717 (not shown)
12416, -000, -xxx

Basic set iBox universal
01700180



Bath spout
12417, -000, -xxx

/ Integrated normal spray ensures
a fast filling of the bathtub



2-hole rim mounted thermostatic
bath mixer
12422, -000, -xxx



4-hole rim mounted thermostatic
bath mixer
12425, -000, -xxx

Basic set
15482180



4-hole tile mounted thermostatic
bath mixer
12426, -000, -xxx

Basic set
15483180



Designed to match the rest of the collection, the exposed bathtub thermostatic mixer, which resembles a branch, is also part of the **harmonious** look in the bathtub area.



Finish set square
28012, -000, -xxx

Finish set oval (not shown)
28022, -000, -xxx

Basic set
15490180

- / sBox for quiet, smooth and safe hose guiding
- / Suitable for rim- or tile-mounted installation
- / Bath rim width at least 100 mm
- / Maximum pull-out length of individually selectable hand shower: 1.45 m



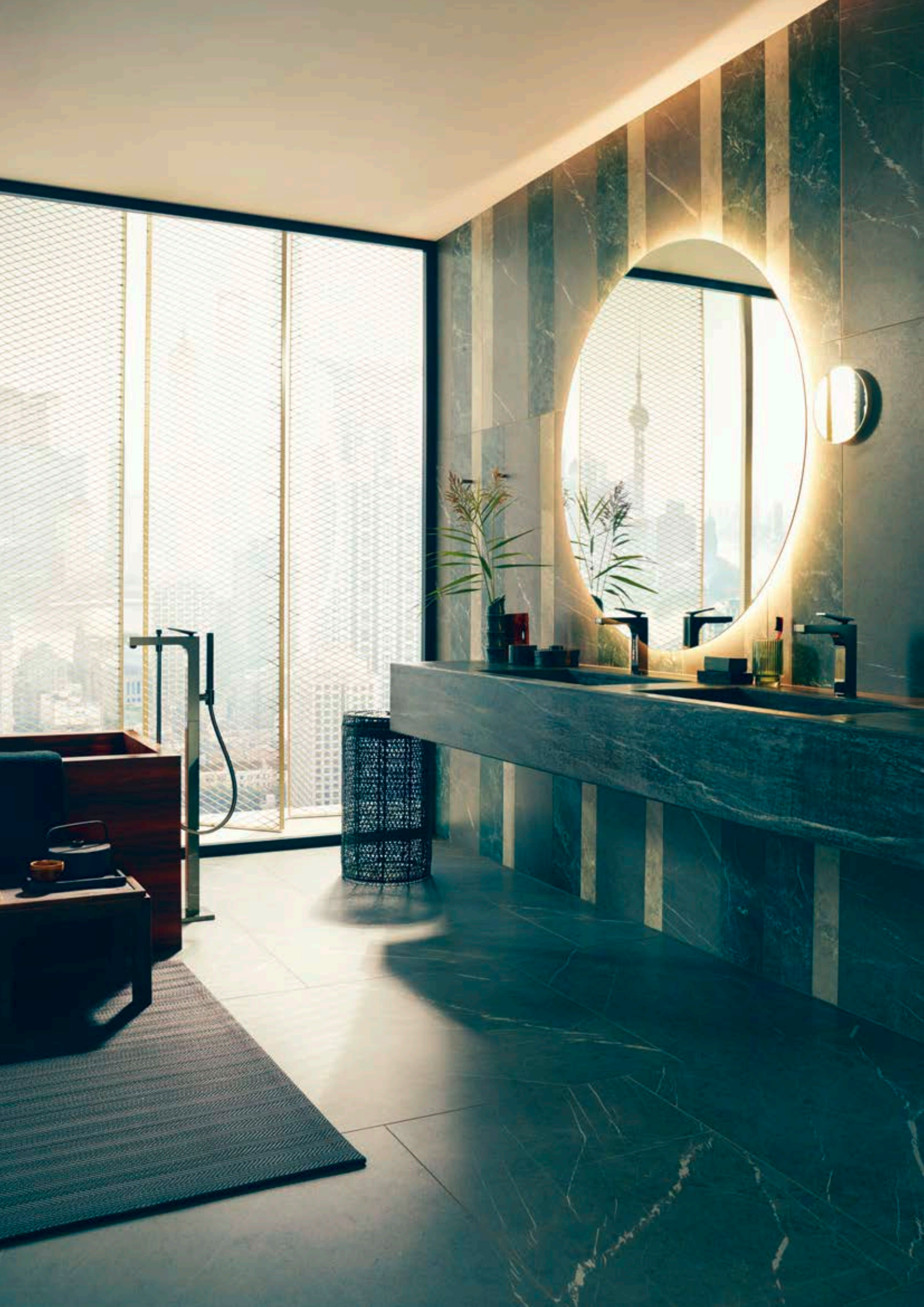

AXOR Citterio

A contemporary classic

AXOR Citterio is an icon of modern bathroom design. Understated yet unmistakably luxurious, with distinctive flat surfaces that brilliantly reflect the light, AXOR Citterio celebrates the preciousness of water itself. With its balanced proportions and elegant geometries, the collection is perfectly suited to any bathroom ambiance.

Design: Antonio Citterio and Toan Nguyen

“THOSE WHO ENJOY
CELEBRATING THE
DAILY RITUAL OF
WASHING SHOULD DO
SO WITH BEAUTIFUL
OBJECTS SUCH AS
AXOR CITTERIO.”

Antonio Citterio

CHARACTERISTIC DESIGN FEATURE:

Monumental faucet design: Geometric precision and striking, flat surfaces – from spout to handles.

THE DESIGNER’S IDEA:

Luxury at second glance: Appreciate the value of water with this special faucet and experience the element more fully.

SPECIAL COLLECTION HIGHLIGHTS:

- / Various handle versions: **modern** pin handle, **classic** cross handle, original lever handle and new, floating lever handle
- / Rhombic cut: The new lever handle’s exclusive surface pattern is a haptic and optical experience
- / The flatness of the spout is an especially striking feature of the collection
- / Extensive product range with different faucet heights, installation possibilities, versions with plate or single escutcheon
- / AXOR Citterio product history: 2003 collection launch, 2010 enhanced design, 2021 extension of the product portfolio. AXOR Citterio is the first of three AXOR collections designed in cooperation with Antonio Citterio. Today, AXOR Citterio is a **classic** in bathroom design.

Learn more about AXOR Citterio:

axor-design.com

A monument at the wash basin

The AXOR Citterio collection offers a variety of product variants: pin, cross and lever handles as well as products with cover plates and escutcheons. Various installation types and diverse spout lengths and faucet heights cover nearly every installation situation. In its geometric precision and monumentality, AXOR Citterio conveys the spirit of Italian neoclassical architecture. The comprehensive product range for wash basin, shower and bathtub enables endless individual solutions, all within a consistent design language.

LEVER HANDLE WITH SURFACE PATTERN

The „rhombic cut“ is a haptic and optical experience and exclusively available for the new lever handle

STRIKING HANDLE DESIGN

Conscious control turns every interaction with water into a celebration

MONUMENTAL DESIGN

Right angles meet rounded shapes and soft radii – characteristic of the collection’s monumental design

FULLY INTEGRATED SPRAY FORMER

Emphasizes the immaculate design

ROUND ESCUTCHEONS

Exciting contrast with the angular design of the faucet body

86



Striking pin handle:

- / Iconic handle with modern, technological enhanced joystick cartridge
- / The striking design creates a deeper awareness and appreciation of water

New lever handle:

- / „Floating“ form continues the architectonic design language
- / Even more ergonomic, intuitive and easy to use
- / Offers precise control of water temperature and volume
- / Optional available with exclusive „rhombic cut“

Classic cross handles:

- / Timeless design, proven functionality and familiar mechanical operation
- / Underscore the classic air of the three-hole mixer version and offer direct and separate control of hot and cold water
- / Available with escutcheons or plate

Wash basin



Single lever basin mixer 160
with pin handle and pop-up waste set
39031, -000, -xxx
with waste set (not shown)
39032, -000, -xxx



Single lever basin mixer 80
with pin handle for hand wash basins
with pop-up waste set
39015, -000, -xxx



Single lever basin mixer 90
with pin handle for hand washbasins
with pop-up waste set
39035, -000, -xxx



Single lever basin mixer 110
with pin handle and pop-up waste set
39010, -000, -xxx
with waste set (not shown)
39018, -000, -xxx



Single lever basin mixer 280
with pin handle for wash bowls
with pop-up waste set
39020, -000, -xxx



Single lever basin mixer 190
with pin handle and pop-up waste set
39034, -000, -xxx
with waste set (not shown)
39037, -000, -xxx



/ Completely integrated spray former
/ Joystick cartridge integrated on the side
/ Due to technical reasons, this product is not available in the surface finishes Polished and Brushed Black Chrome

87



Single lever basin mixer 90
with lever handle for hand washbasins
with pop-up waste set
39022, -000, -xxx
with rhombic cut (not shown)
39001, -000, -xxx



Single lever basin mixer 160
with lever handle
and pop-up waste set
39023, -000, -xxx
with rhombic cut (not shown)
39071, -000, -xxx



Single lever basin mixer 160
with lever handle and waste set
39024, -000, -xxx
with rhombic cut (not shown)
39081, -000, -xxx



Single lever basin mixer 280
with lever handle for wash bowls
with waste set
39021, -000, -xxx
with rhombic cut (not shown)
39151, -000, -xxx





Wash basin



3-hole basin mixer 170
with spout 140 mm, cross handles,
plate and pop-up waste set
39134, -000, -xxx



3-hole basin mixer 170
with spout 140 mm, cross handles,
escutcheons and pop-up waste set
39133, -000, -xxx



3-hole basin mixer 170
with spout 140 mm, lever handles,
plate and pop-up waste set
39136, -000, -xxx



3-hole basin mixer 170
with spout 140 mm, lever handles,
escutcheons and pop-up waste set
39135, -000, -xxx



3-hole basin mixer
for concealed installation
wall-mounted with spout 166 mm,
cross handles and plate
39314000

with spout 226 mm (not shown)
39144, -000, -xxx

Basic set
10303180



3-hole basin mixer
for concealed installation wall-
mounted with spout 162 mm,
cross handles and escutcheons
39313, -000, -xxx

with spout 222 mm (not shown)
39143, -000, -xxx

Basic set
10303180



3-hole basin mixer
for concealed installation wall-
mounted with spout 226 mm,
lever handles and plate
39148, -000, -xxx

Basic set
10303180



3-hole basin mixer
for concealed installation wall-
mounted with spout 162 mm,
cross handles and escutcheons
39313, -000, -xxx

with spout 222 mm (not shown)
39143, -000, -xxx

Basic set
10303180



A variety of products with perfect form



Single lever basin mixer 190 with pin handle and pop-up waste set in Brushed Gold Optic.

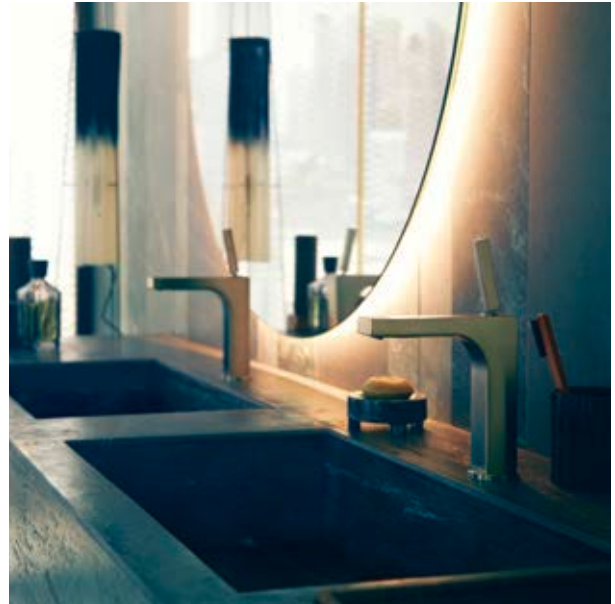

Single-hole lavatory faucet 160 with pin handle in Brushed Nickel.

90

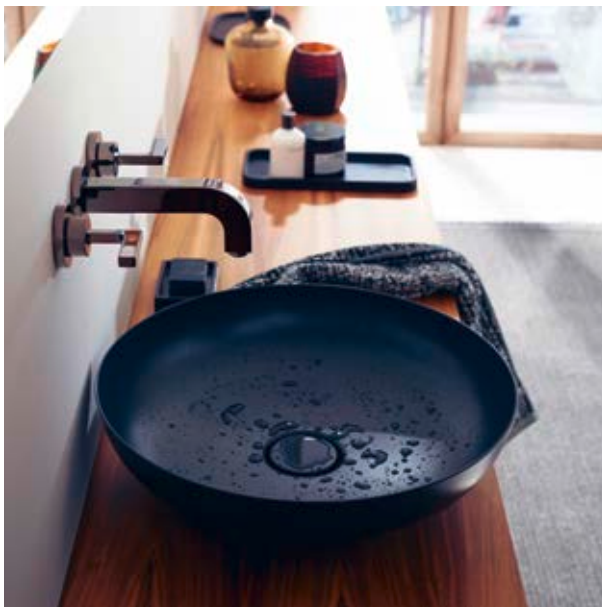

Three-hole basin mixer for concealed installation, wall-mounted, with spout 162 mm, lever handles and escutcheons in Polished Black Chrome.

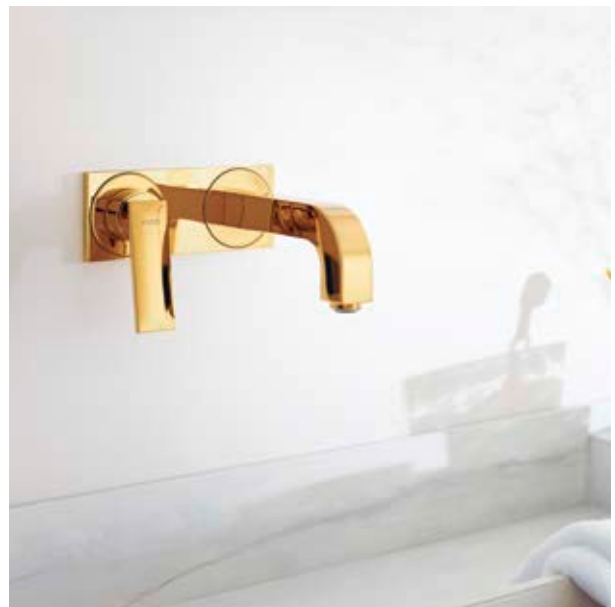

Single lever basin mixer for concealed installation, wall-mounted, with flat lever handle, spout 220 mm and cover plate in Polished Gold Optic.

Wash basin



Single lever basin mixer
for concealed installation
wall-mounted with pin handle,
spout 160 mm and plate
39112, -000, -xxx
with spout 220 mm (not shown)
39115, -000, -xxx

Basic set
13623180



Single lever basin mixer
for concealed installation
wall-mounted with pin handle,
spout 160 mm and escutcheons
39113, -000, -xxx
with spout 220 mm (not shown)
39116, -000, -xxx

Basic set
13623180



Single lever basin mixer
for concealed installation
wall-mounted with lever handle,
spout 220 mm and plate
39119, -000, -xxx
with rhombic cut (not shown)
39171, -000, -xxx

Basic set
13623180



Single lever basin mixer
for concealed installation
wall-mounted with lever handle,
spout 220 mm and escutcheons
39121, -000, -xxx
with rhombic cut (not shown)
39181, -000, -xxx

Basic set
13623180



/ Handle can be positioned on the right or left, depending on the individual requirements of the customer and the installation of the basic set

Bidet



Single lever bidet mixer
with pop-up waste set
39210, -000, -xxx



Single lever bidet mixer
with lever handle
and pop-up waste set
39214, -000, -xxx
with rhombic cut (not shown)
39201, -000, -xxx

Striking design in the shower

The exposed shower system provides superior showering comfort. It offers total flexibility with regard to installation and is especially suitable for renovations. It's easy to adjust the spray angle of the overhead shower which is equipped with the Rain spray mode. The integrated thermostatic mixer technology saves water and can be used to set the desired shower temperature precisely. The SafetyStop function prevents scalding.

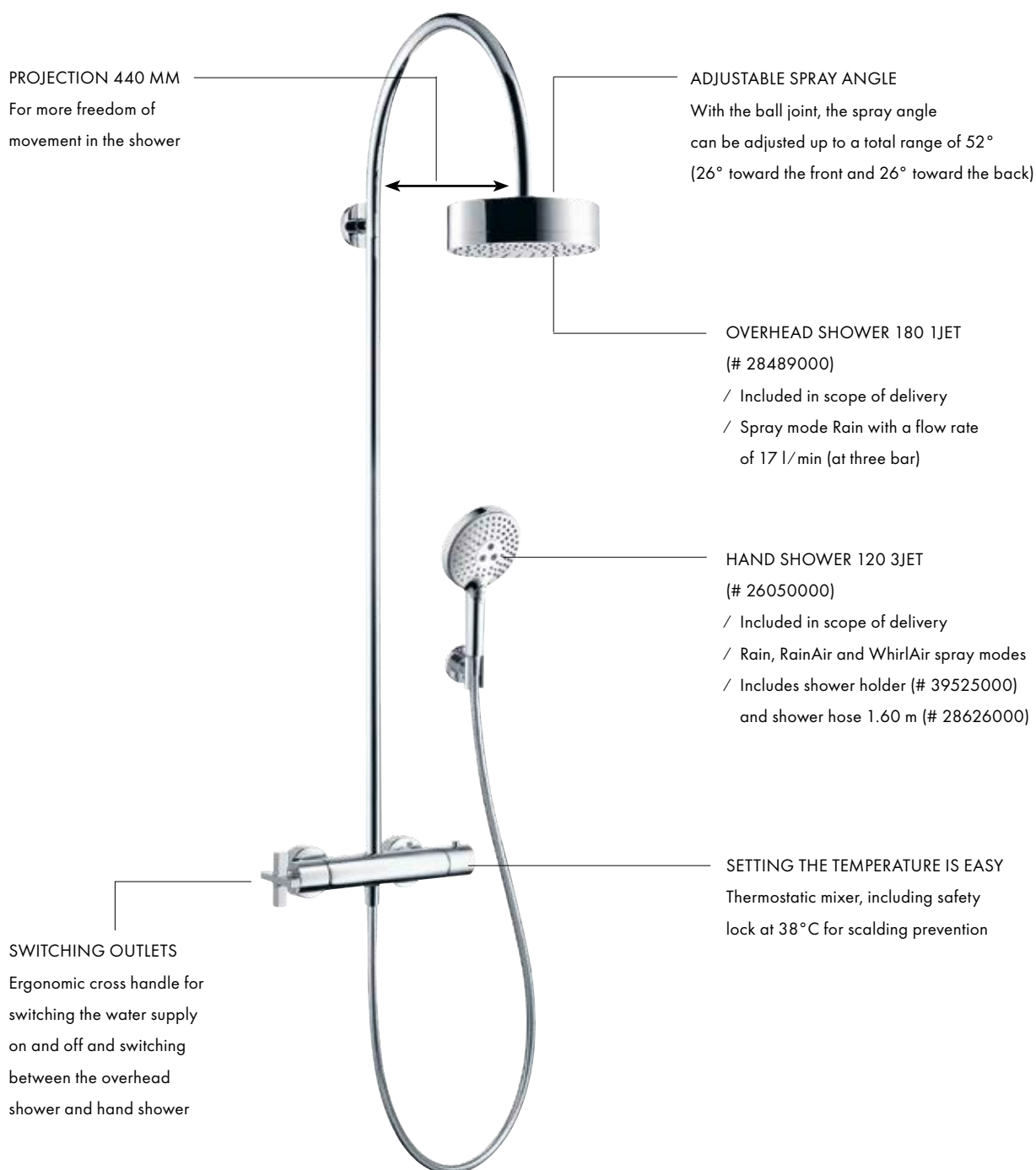

Shower



Showerpipe with single lever mixer and overhead shower 180 1jet
39620, -000, -xxx



Showerpipe with thermostat and overhead shower 180 1jet
39670, -000, -xxx



Single lever shower mixer for exposed installation with lever handle
39600, -000, -xxx



Single lever shower mixer for concealed installation with lever handle
39655, -000, -xxx
Basic set iBox universal
01700180



Thermostat HighFlow for concealed installation with cross handle
39716, -000, -xxx
Basic set iBox universal
01700180



Thermostat HighFlow for concealed installation with lever handle
39711, -000, -xxx
Basic set iBox universal
01700180



Thermostat for concealed installation with shut-off valve and cross handle
39705, -000, -xxx
Basic set iBox universal
01700180



Thermostat for concealed installation with shut-off valve and lever handle
39700, -000, -xxx
Basic set iBox universal
01700180



Thermostat for concealed installation with shut-off/diverter valve and cross handle
39725, -000, -xxx
Basic set iBox universal
01700180



Thermostat for concealed installation with shut-off/diverter valve and lever handle
39720, -000, -xxx
Basic set iBox universal
01700180



Shower



Shut-off/diverter valve Trio/Quattro for concealed installation with cross handle
39925, -000, -xxx

with lever handle (not shown)
39920, -000, -xxx

Basic set Quattro
16930180

Basic set Trio
16982180



Shut-off valve for concealed installation with cross handle
39965, -000, -xxx

Basic set 52 l/min spindle
16973180

Basic set 40 l/min ceramic
16974180

Basic set 130 l/min spindle
16970180



Shut-off valve for concealed installation with lever handle
39960, -000, -xxx

Basic set 52 l/min spindle
16973180

Basic set 40 l/min ceramic
16974180

Basic set 130 l/min spindle
16970180



Wall outlet stop with non return valve, shut-off valve and cross handle
39883, -000, -xxx



Wall outlet stop with non return valve, shut-off valve and lever handle
39882, -000, -xxx



Overhead shower 180 ljet
28489, -000, -xxx



/ Combinable with:
/ Shower arm 390 mm
(# 26431, -000, -820, -xxx)
/ Ceiling connection 100 mm
(# 26432, -000, -820, -xxx)
/ Ceiling connection 300 mm
(# 26433, -000, -xxx)



Shower set 0.90 m with hand shower 120 3jet
27991, -000, -xxx



/ Included in scope of delivery:
/ Hand shower 120 3jet
(# 26050, -000, -xxx)
/ Shower hose 1.60 m
(# 28626, -000, -xxx)



Shower bar 0.90 m
27831, -000, -xxx

/ Included in scope of delivery:
/ Shower hose 1.60 m
(# 28626, -000, -xxx)



Porter unit 120/120 with baton hand shower 2jet and shower hose
12626, -000, -xxx



Shower holder round
39525, -000, -xxx

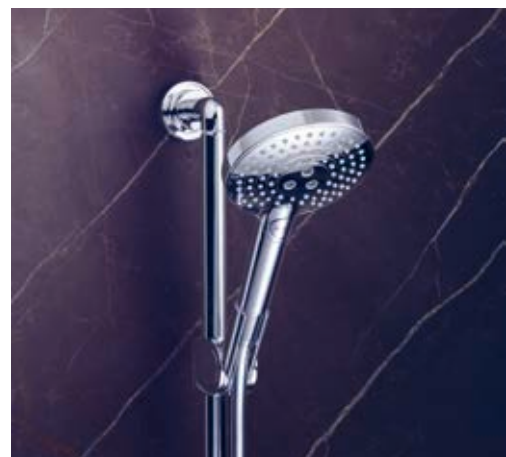





Single lever bath mixer floor-standing with pin handle
39451, -000, -xxx

Basic set
10452180



Single lever bath mixer floor-standing with lever handle
39440, -000, -xxx

with rhombic cut (not shown)
39471, -000, -xxx

Basic set
10452180



Single lever bath mixer for concealed installation with lever handle
39455, -000, -xxx

with integrated security combination according to EN1717 (not shown)
39457, -000, -xxx

Basic set iBox universal
01700180



Bath spout
39410, -000, -xxx



Single lever bath mixer for exposed installation with lever handle
39400, -000, -xxx



3-hole rim mounted bath mixer with cross handles
39436, -000, -xxx

Basic set
15484180



At the bathtub: a special radiance

The traditional, wall-mounted bathtub mixer with classic cross handles underscores the monumental design. The geometric precision and striking flatness of the products for the wash basin and shower is carried over to the bathtub.

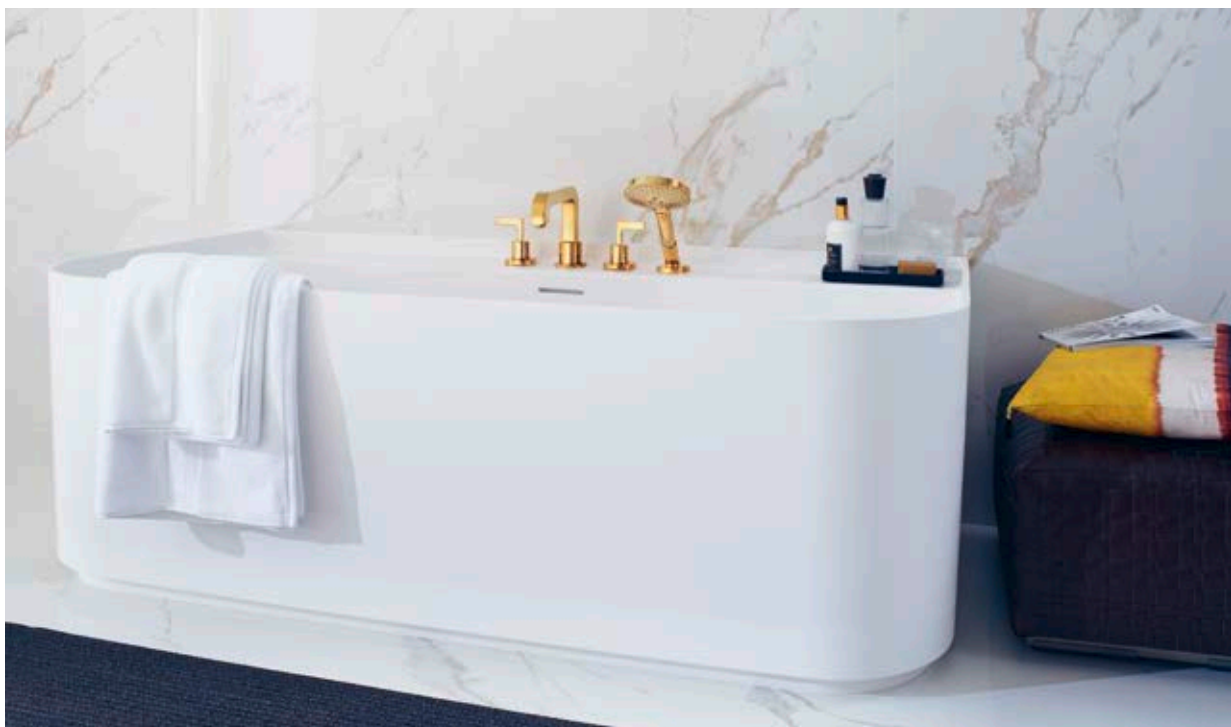
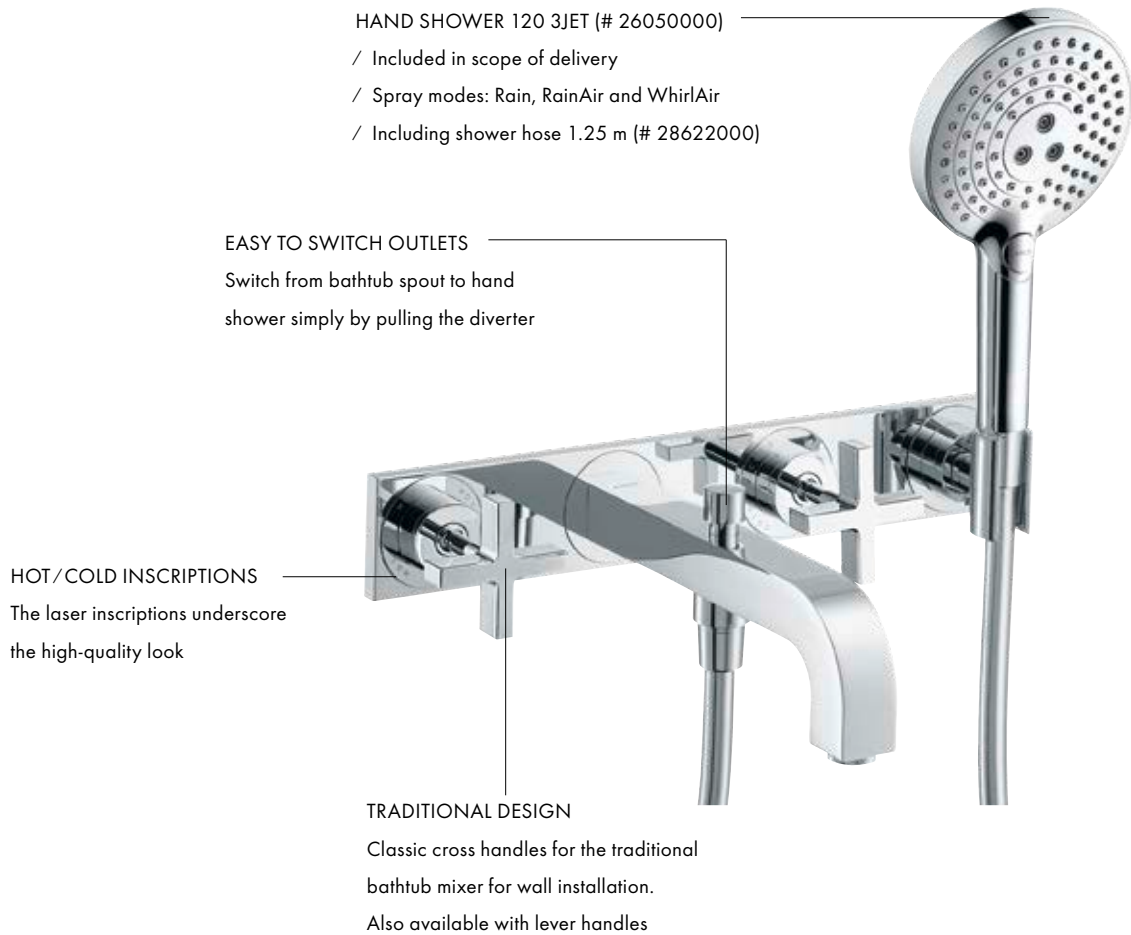



3-hole bath mixer for concealed installation wall-mounted with cross handles and plate
39441, -000, -xxx

Basic set
10303180

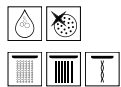

3-hole bath mixer for concealed installation wall-mounted with cross handles and escutcheons
39447, -000, -xxx

Basic set
10303180

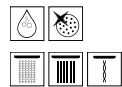

3-hole bath mixer for concealed installation wall-mounted with lever handles and plate
39442, -000, -xxx

Basic set
10303180



3-hole bath mixer for concealed installation wall-mounted with lever handles and escutcheons
39448, -000, -xxx



4-hole rim mounted bath mixer with cross handles and escutcheons
39445, -000, -xxx

Basic set
15480180



4-hole tile mounted bath mixer with cross handles and escutcheons
39453, -000, -xxx

Basic set
15481180



4-hole rim mounted bath mixer with cross handles and escutcheons
39445, -000, -xxx

Basic set
15480180



4-hole tile mounted bath mixer with lever handles and escutcheons
39454, -000, -xxx

Basic set
15481180

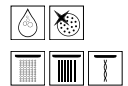

2-hole rim mounted thermostatic bath mixer with cross handles
39480, -000, -xxx

Basic set
15486180



2-hole rim mounted thermostatic bath mixer with lever handles
39482, -000, -xxx

Basic set
15486180



Finish set square
28012, -000, -xxx

Finish set oval (not shown)
28022, -000, -xxx

Basic set
15490180

- / sBox for quiet, smooth and safe hose guiding
- / Suitable for rim- or tile-mounted installation
- / Bath rim width at least 100 mm
- / Maximum pull-out length of individually selectable hand shower: 1.45 m



AXOR Citterio E

The essence of elegance

AXOR Citterio E perfects the beauty of **proportionality** and connects curved and angular shapes, familiar and new, classic and modern, to create a timelessly **elegant** form. Balanced right down to the last detail. This is the E in AXOR Citterio E. **Harmony** is created in the balance of opposites.

Design: Antonio Citterio

“AXOR CITTERIO E IS
A REDESIGN OF AN
EVERYDAY OBJECTS.
THESE LITTLE, BUT
REFINED DETAILS ARE
EXTREMELY IMPORTANT
FOR PERCEPTION.”

Antonio Citterio

CHARACTERISTIC DESIGN FEATURE:

Elegant, **timeless** design: Soft, round shapes, a tapered spout and classic cross handles that are especially ergonomic.

101

THE DESIGNER'S IDEA:

A symbiosis of opposites to create perfect beauty: With AXOR Citterio E we wanted to create something simple, but with high tangible and visible quality, to serve as an antidote to our complex world.

SPECIAL COLLECTION HIGHLIGHTS:

- / Three handle variants: the **classic** cross handle, the **modern** pin handle and the **ergonomic** lever handle
- / Modern functionality: pin handle, shower set with metal slider, thermostatic module with various handles for different functions and, unambiguous, ergonomic control
- / Select products from the collection available in Matt Black
- / AXOR Citterio E is the third collection in cooperation with Antonio Citterio

Learn more about AXOR Citterio E:

axor-design.com

A perfect symbiosis of right angles and soft, round shapes

Elegance and ease of use come together in the single-hole lavatory faucet. Precisely worked surfaces and edges are combined with gentle shapes and escutcheons in Softsquare design. Different handle variants, such as the slim joystick handle or the lever handle, are an expression of high quality.



102



Cross handles, with their classic look, characterize the three-hole wash basin mixers. Ergonomic, with soft radii, they are easy to grip and to operate.

Wash basin



Single lever basin mixer 130 with pop-up waste set # 36100, -000, -670, -xxx with waste set (not shown) # 36101, -000, -670, -xxx



Single lever basin mixer 90 for hand washbasins with waste set # 36102, -000, -xxx



Single lever basin mixer 190 for washbowls with waste set # 36103, -000, -xxx



Single lever basin mixer 250 for washbowls with waste set # 36104, -000, -670, -xxx



Pillar tap 90 without waste set # 36105, -000, -xxx



Single lever basin mixer 130 with lever handle and pop-up waste set # 36110, -000, -670, -xxx with waste set (not shown) # 36111, -000, -670, -xxx



Single lever basin mixer 90 with lever handle for hand washbasins with waste set # 36112, -000, -xxx



Single lever basin mixer 250 with lever handle for washbowls with waste set # 36113, -000, -670, -xxx



103

Bidet



Single lever basin mixer for concealed installation wall-mounted with spout 221 mm and escutcheons # 36106, -000, -670, -xxx with plate (not shown) # 36114, -000, -xxx

Basic set # 13623180



/ Handle can be positioned on the right or left, depending on the individual requirements of the customer and the installation of the basic set



3-hole basin mixer for concealed installation wall-mounted with plate # 36115, -000, -xxx with escutcheons (not shown) # 36107, -000, -670, -xxx

Basic set # 10303180



3-hole basin mixer 170 with plate and pop-up waste set # 36116, -000, -xxx with escutcheons (not shown) # 36108, -000, -670, -xxx



Single lever bidet mixer with pop-up waste set # 36120, -000, -670, -xxx

with lever handle and pop-up waste set (not shown) # 36121, -000, -xxx

Single lever basin mixer 130 with bidette hand shower and shower hose 1.60 m (not shown) # 36130, -000, -670, -xxx



Elegance and functionality in the shower

The scope for individual design is almost boundless. The thermostatic module 380/120 can be installed with individual escutcheons for three functions or with a plate for two functions. In connection with the basic set based on the modular principle of the AXOR ShowerCollection, installation can be carried out for customized dimensions in rows spaced 10 mm apart. The building block system and the optional 120/120 square product grid offer more options for individuality and creativity in shower planning.

104

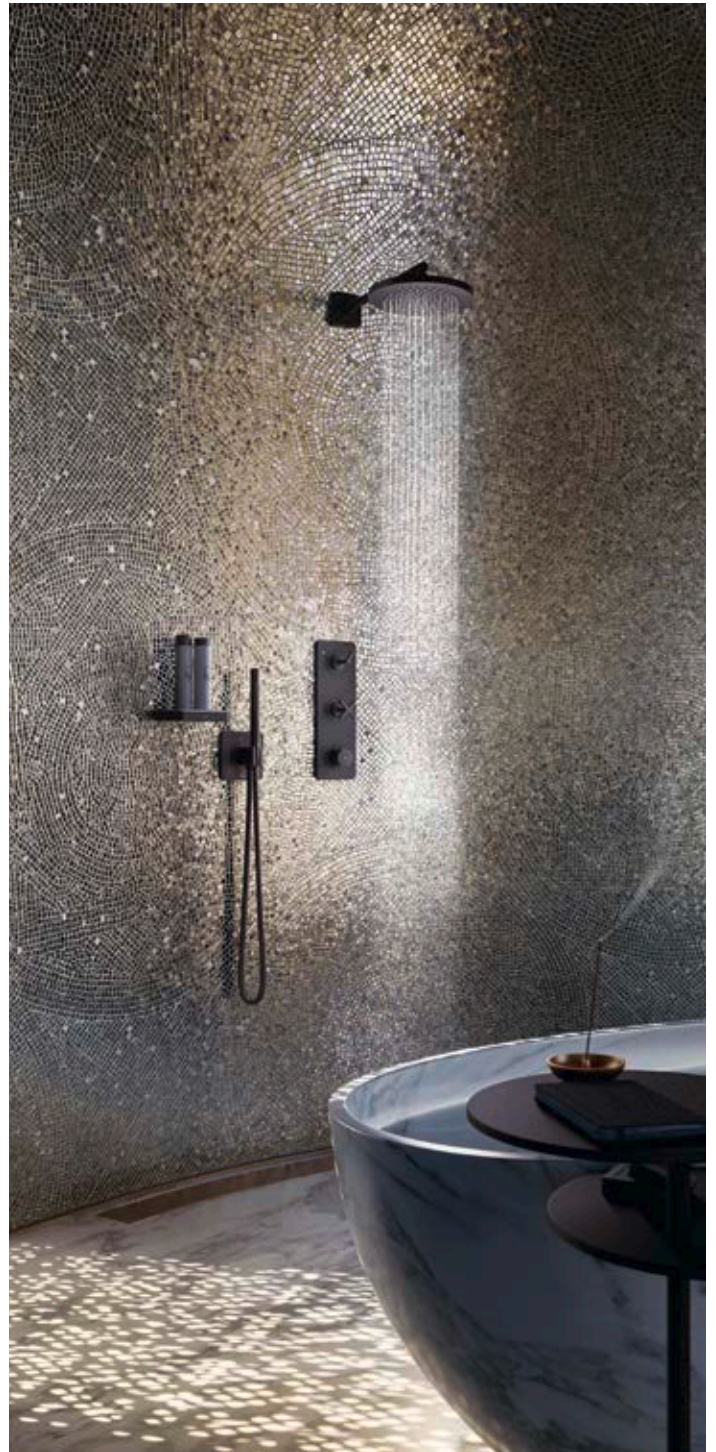

Shower



Single lever shower mixer
for concealed installation
36655, -000, -670, -xxx
Basic set iBox universal
01700180



Thermostatic module 380/120
for concealed installation
for 3 functions with escutcheons
36704, -000, -670, -xxx
Basic set
36708180



Thermostatic module 380/120
for concealed installation
for 2 functions with plate
36703, -000, -670, -xxx
Basic set
36701180



Thermostatic module 120/120
for concealed installation
36702, -000, -670, -xxx
Basic set
10754180

/ Vertical or horizontal installation possible
/ Simultaneous utilization of 2 outlets possible



Shut-off valve 120/120
for concealed installation
36771, -000, -670, -xxx
Basic set
10971180

Basic set 52 l/min spindle
16973180

Basic set 40 l/min ceramic
16974180

Basic set 130 l/min spindle
16970180



Shut-off/diverter valve Trio/Quattro
120/120 for concealed installation
36772, -000, -670, -xxx
Basic set for Trio 120/120
36770180

Basic set Trio
16982180

Basic set Quattro
16930180



Shower bar 0.90 m
36736, -000, -xxx

/ Included in scope of delivery:
shower hose 1.60 m
(28626, -000, -xxx)

Optional parts:
/ cover for rail
(42871, -000, -xxx)



Shower set 0.90 m
with hand shower 120 3jet
36735, -000, -xxx



/ Included in scope of delivery:
Hand shower 120 3jet
(# 26050, -000, -xxx)
shower slider
(# 92726, -000, -xxx),
shower hose 1.60m
(# 28626, -000, -xxx)

Optional parts:
/ Cover for rail
(# 42871, -000, -xxx)



Porter unit 120/120 softsquare
36724, -000, -670, -xxx
Basic set
28486180

/ For shower hoses with
conical nuts on both sides



Wall plate 120/120 softsquare
36725, -000, -xxx

Combinable with:
/ Shower arm 389 mm
(# 27348, -000, -xxx)
/ Overhead shower 240 1jet
(# 28474, -000, -xxx)



Shower module 120/120
for concealed installation softsquare
36822, -000, -xxx



/ Field of application:
functions as overhead,
shoulder or side shower
/ Spray angle adjustable
in five steps

Optional parts:
/ Basic set # 28486180
/ Installation part # 28470180

Intuitive and ergonomic operation at the bathtub

BATON HAND SHOWER 2JET
(# 28532000)

/ Included in scope of delivery

INTEGRATED THERMOSTATIC MIXER

/ Safety lock at 40°C

/ With cross handle for convenient
temperature setting

SHOWER HOSE 1.25 M
(# 28622000)

/ Included in scope of delivery

SWITCHING OUTLETS

Simply pull to switch ergonomically
from bathtub spout to hand shower

VOLUME CONTROL

Open and close as well as volume
control for water supply

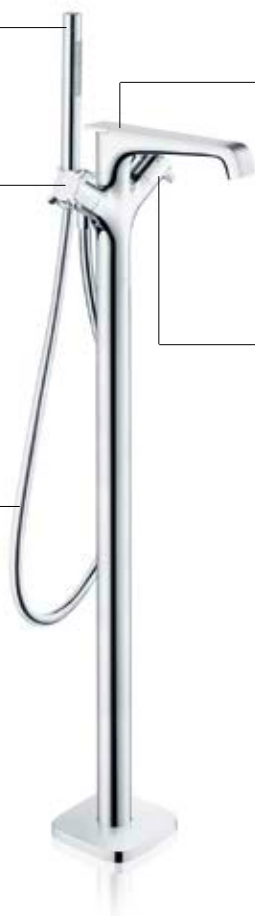

106



The four-hole rim-mounted mixer is a timeless, elegant product for the bathtub. At the same time, the handles offer intuitive operation: the temperature with the cylindrical handle, the water flow with the ergonomic cross handle.



The floor-standing thermostatic mixer for the bathtub is an eye-catcher. The simple baton hand shower has two spray modes, the elegant cross handle controls water flow, and the thermostatic mixer is used to set the temperature.



Bath thermostat floor-standing
36416, -000, -670, -xxx

Basic set
10452180



Bath thermostat
for exposed installation
36140, -000, -xxx



Bath spout
36425, -000, -670, -xxx



Single lever bath mixer
for concealed installation
36455, -000, -670, -xxx

Basic set iBox universal
01700180



4-hole rim mounted thermostatic
bath mixer
36411, -000, -670, -xxx

Basic set
15482180



4-hole tile mounted thermostatic
bath mixer
36410, -000, -670, -xxx

Basic set
15483180



Finish set oval
28022, -000, -xxx

Finish set square (not shown)
28012, -000, -xxx

Basic set
15490180

- / sBox for quiet, smooth and safe hose guiding
- / Suitable for rim- or tile-mounted installation
- / Bath rim width at least 100 mm
- / Maximum pull-out length of individually selectable hand shower: 1.45 m



2-hole rim mounted thermostatic
bath mixer
36412, -000, -xxx

Basic set
15486180

- Optional parts:
- / sBox finish set square (# 28012, -000, -xxx) or
 - / sBox finish set oval (# 28022, -000, -xxx)



AXOR Citterio M

Urban lifestyle

M as in metropolis. AXOR Citterio M stands for cultivated, **urban** living. With simple, slim forms and clearly defined lines, the collection is an expression of modern, urban **elegance**. With a quiet and understated presence in the bathroom. A masterpiece, offering an everyday retreat from the frenetic pace of the city.

Design: Antonio Citterio and Toan Nguyen

"IF I HAVE ONLY A SMALL SPACE AVAILABLE, IT IS EVEN MORE IMPORTANT THAT I FURNISH IT WITH CAREFULLY SELECTED, VALUABLE OBJECTS - SUCH AS AXOR CITTERIO M."

Antonio Citterio

CHARACTERISTIC DESIGN FEATURE:

Clear, svelte, quiet and understated: characteristically slim, simple, cylindrical forms and elegant surfaces

THE DESIGNER'S IDEA:

A symbol for urbanization: AXOR Citterio M is a collection that meets the demands of modern, urban life. All with modern **elegance** and slender forms

SPECIAL COLLECTION HIGHLIGHTS:

- / Variants: single lever, two-hole and three-hole mixers
- / Clear, easy operation with flat lever handles
- / **Timeless urban design**: space-saving wall-mounted mixers, understated elements for the bathroom
- / Perfect form: the first AXOR mixer with a fully integrated spray former
- / AXOR Citterio M, the second collection in cooperation with Antonio Citterio, was introduced in 2008

Learn more about AXOR Citterio M:

axor-design.com

Delicate and understated design for the modern metropolis

AXOR Citterio M – a bathroom collection inspired by **modern** city life. M as in modernity. Metropolis. Milan. With characteristically slim forms, the overall impression is particularly **elegant** and a nod to Italian design. The collection fits easily and seamlessly into a variety of bathroom furnishings and **lifestyles**. The slim, single lever mixer with a flat handle and striking spout is both modern and **timeless**. Combinations are possible with wash basins of nearly any form with this extraordinary **classic** and elegant design.

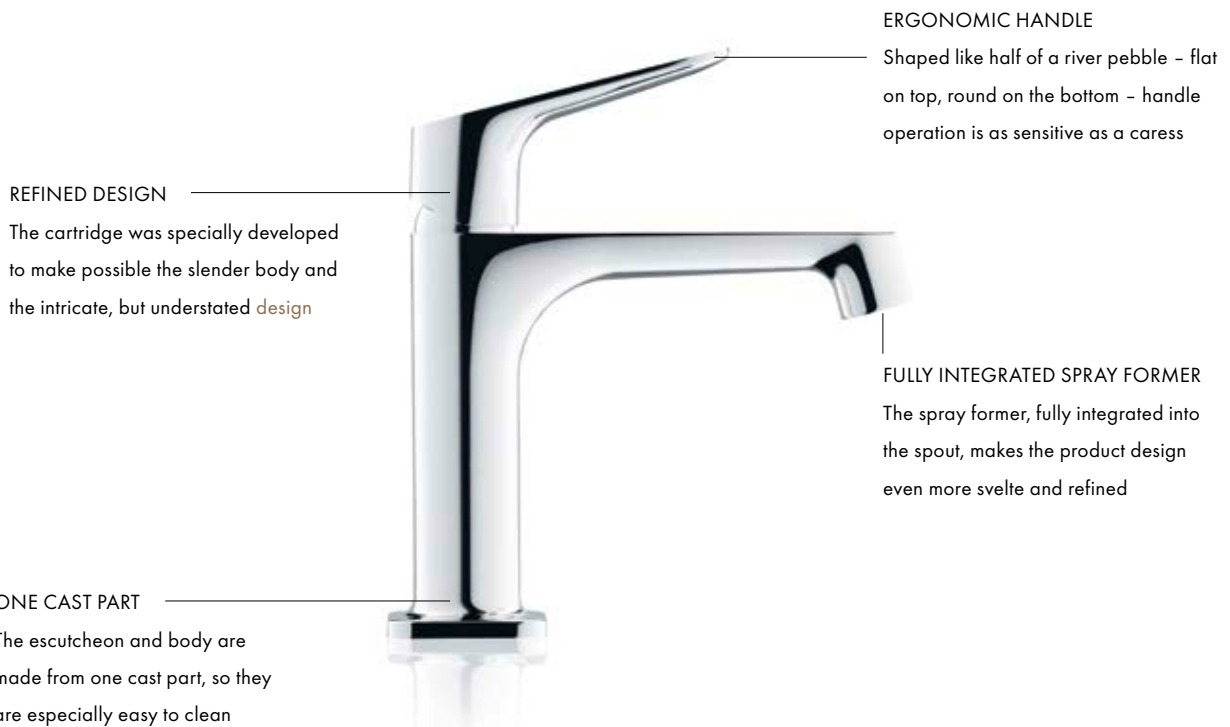

110



Urban chic in all of its rich variations:
With its various design versions, the concealed, wall-mounted mixer offers a modern, space-saving solution.



Classic in function, **modern** in design:
The mixer comes to life in the **tension** between its traditional three-hole arrangement and the clear, uncomplicated form.

Wash basin



Single lever basin mixer 100
with pop-up waste set
34010, -000, -xxx
with waste set (not shown)
34017, -000, -xxx



Single lever basin mixer 70
for hand wash basins
with pop-up waste set
34016, -000, -xxx



Single lever basin mixer 250
for wash bowls with waste set
34127, -000, -xxx



3-hole basin mixer 160
with lever handles, escutcheons
and pop-up waste set
34133, -000, -xxx



2-hole basin mixer 160
with pop-up waste set
34132, -000, -xxx



Single lever basin mixer
for concealed installation
wall-mounted with spout 167 mm
and plate
34112, -000, -xxx

with spout 227 mm (not shown)
34115, -000, -xxx

Basic set
13623180



Single lever basin mixer
for concealed installation
wall-mounted with spout 167 mm
and escutcheons
34113, -000, -xxx

with spout 227 mm (not shown)
34116, -000, -xxx

Basic set
13623180



3-hole basin mixer
for concealed installation
wall-mounted with spout 166 mm,
lever handles and escutcheons
34313, -000, -xxx

with spout 226 mm, lever handles
and escutcheons (not shown)
34315, -000, -xxx

Basic set
10303180



/ Handle can be positioned on the right or left, depending on the individual requirements of the customer and the installation of the basic set

Bidet



Pillar tap 90 without waste set
34130, -000, -xxx



Single lever bidet mixer
with pop-up waste set
34210, -000, -xxx



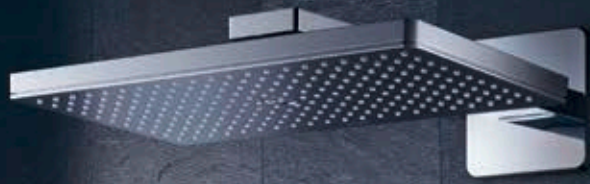

Shower



Single lever shower mixer
for exposed installation
34620, -000, -xxx



Shower thermostat
for exposed installation
34635, -000, -xxx



Single lever shower mixer
for concealed installation
34625, -000, -xxx

Basic set iBox universal
01700180



Thermostat HighFlow
for concealed installation
34716, -000, -xxx

Thermostat for concealed installation
(not shown)
34715000

Basic set iBox universal
01700180



Thermostat for concealed installation
with shut-off valve
34705, -000, -xxx

Basic set iBox universal
01700180



Thermostat for concealed installation
with shut-off/diverter valve
34725, -000, -xxx

Basic set iBox universal
01700180



Thermostat for concealed installation
softsquare for 2 functions
36707, -000, -670, -xxx

Basic set iBox universal
01700180



/ Further matching AXOR
ShowerSelect products
can be found in the AXOR
Showers chapter



Shut-off/diverter valve Trio/Quattro
for concealed installation
34920, -000, -xxx

Basic set Trio
16982180

Basic set Quattro
16930180



Shut-off valve
for concealed installation
with lever handle
34960, -000, -xxx

Basic set 52 l/min spindle
16973180

Basic set 40 l/min ceramic
16974180

Basic set 130 l/min spindle
16970180



Porter unit
11626, -000, -xxx

Matching complementary products:
/ Hand shower 120 3jet
(# 26050, -000, -xxx)
/ Shower hose
(# 28622, -000, -xxx)

Modern design for the bathtub

The intricately designed AXOR Citterio M four-hole rim-mounted mixer is the ideal product choice for the tub in **modern** bathrooms. The lever handles – shaped like halves of a river pebble – offer **ergonomic** operation, like a caress for the hands. AXOR Citterio M meets all the requirements of **urban** living for a variety of applications in the bathroom.





Single lever bath mixer
for exposed installation
34420, -000, -xxx



Single lever bath mixer
for concealed installation
34425000

with integrated security combination
according to EN1717 (not shown)
34427, -000, -xxx

Basic set iBox universal
01700180



Bath spout
34410, -000, -xxx



Bath thermostat
for exposed installation
34435, -000, -xxx



4-hole rim mounted bath mixer
with lever handles and escutcheons
34444, -000, -xxx

Basic set
15480180



4-hole tile mounted bath mixer
with lever handles and escutcheons
34454, -000, -xxx

Basic set
15481180

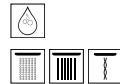

Finish set oval
28022, -000, -xxx

Finish set square (not shown)
28012, -000, -xxx

Basic set
15490180

- / sBox for quiet, smooth and safe hose guiding
- / Suitable for rim- or tile-mounted installation
- / Bath rim width at least 100 mm
- / Maximum pull-out length of individually selectable hand shower: 1.45 m



Elegance across the board: the simple, reduced bath mixers of the AXOR Citterio M collection.





AXOR

AXOR Urquiola

Poetry for the senses

AXOR Urquiola is a many-faceted collection that embodies eclectic design principles. A skillful mix of styles and influences, a fascinating interplay of references and symbols, a harmonious whole created from distinct elements and interesting details. A variety of forms – asymmetrical and flat – come together to form something new and unique. Simultaneously sensuous and functional. An expression of the great art of style fusion.

Design: Patricia Urquiola

“LITTLE MEMORIES AND
PERSONAL OBJECTS
ARE WHAT MAKE A
ROOM FEEL LIKE HOME.
THE MIXER HAS TO BE
PERSONAL, JUST AS WITH
AXOR URQUIOLA.”

Patricia Urquiola

CHARACTERISTIC DESIGN FEATURE:

Skillful style fusion: With its asymmetries and flat surfaces, intricate details, radii and the skillful interplay of various forms, the collection expresses the unexpected. This is eclecticism. Yet the collection, while surprising, is harmonious and sensuous in its overall look.

THE DESIGNER'S IDEA:

Elements and impressions of life come together naturally – everything in harmony.

SPECIAL COLLECTION HIGHLIGHTS:

- / Eclecticism: a fusion of various style elements that invokes the unconventional
- / AXOR Urquiola is characterized by expansive surfaces, extraordinary details and a sensual look
- / This elegant design features handles with large openings for a delicate overall impression, despite the amplitude of the basic form
- / Sink and bath tub in a reinterpreted form of the historical washtub
- / AXOR Urquiola is the realization of Patricia Urquiola's vision of the bathroom. It was conceptualized as part of the AXOR WaterDreams 2005

A fusion of styles and elements

The shifting interplay of personal memories and impressions forms the basis of the AXOR Urquiola collection. Abandoning conformity, convention and rigid structures. Embracing multifaceted, richly detailed worlds of style full of *sensuality* and powerful energy. With its lively *style mixture*, AXOR Urquiola offers a new freedom to create individually designed oases in which the details fuse together into a *harmonious* whole.

WATER CONSUMPTION

Flow rate for all wash basin mixers: 5 l/min (at 3 bar)

ELEGANT HANDLE DESIGN

The generously sized openings in the handles, an overall design feature, enable intuitive, *ergonomic* operation. Despite their ample form, the handles appear light and delicate

AN EXCITING DESIGN DETAIL

The surface of the mixer spout is interrupted by a perfectly crafted wave. This unusual design feature – a reference to a bamboo shoot – underscores the *organic design*

SOFT EXPANSIVE

AXOR Urquiola is characterized by its combination of expansive, perfectly crafted surfaces with soft, but precise, radii



118

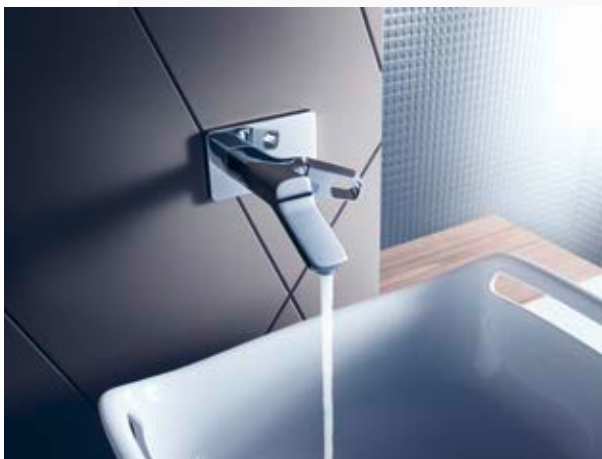

Nostalgic accents:

The form of the wash basin recalls traditional wash bowls of years gone by.



Practical handles:

The integrated handles also serve as towel holders.

Wash basin



Single lever basin mixer 130
with pop-up waste set
11020, -000, -xxx
with waste set (not shown)
11021, -000, -xxx



Single lever basin mixer 280
for wash bowls with waste set
11035, -000, -xxx



/ Particularly suitable for
free-standing wash bowls
of the AXOR Urquiola
collection (# 11300000
and # 11301000)



Single lever basin mixer 110
for hand wash basins
with pop-up waste set
11025, -000, -xxx



Single lever basin mixer
for concealed installation
wall-mounted with spout 200 mm
11026, -000, -xxx

Basic set
10902180



/ Particularly suitable for the
wall-mounted wash basin
of the AXOR Urquiola
collection (# 11302000)



2-handle basin mixer 120
with pop-up waste set
11024, -000, -xxx



3-hole basin mixer 50
with plate and pop-up waste set
11040, -000, -xxx



3-hole basin mixer 50
with escutcheons
and pop-up waste set
11041, -000, -xxx



3-hole basin mixer
for concealed installation
wall-mounted with spout 168 mm
11042, -000, -xxx

with spout 228 mm (not shown)
11043, -000, -xxx

Basic set
10303180



/ Particularly suitable for the
wall-mounted wash basin
of the AXOR Urquiola
collection (# 11302000)

119

Bidet



Wash bowl 624/408
11300000

/ Counter top wash bowl
/ Only in conjunction with basin mixers with non-closing waste set
/ Material: mineral cast with gel coat
/ TÜV certified
/ Optional parts:
/ Waste set non-closing for wash basins (# 51301000)



Wash bowl 511
11301000



Wash basin 624/399 wall-mounted
11302000

/ Wall-mounted
/ Only in conjunction with basin
mixers with non-closing waste set
/ Material: mineral cast
with gel coat
/ TÜV certified
Optional parts:
/ Waste set non-closing for
wash basins (# 51301000)



Single lever bidet mixer
with pop-up waste set
11220, -000, -xxx



Shower



Single lever shower mixer
for exposed installation
11620, -000, -xxx



Single lever shower mixer
for concealed installation
11625, -000, -xxx

Basic set iBox universal
01700180



Porter unit
11626, -000, -xxx

/ Für Brauseschläuche mit
beidseitig konischer Mutter



Thermostat HighFlow
for concealed installation
11731, -000, -xxx

Basic set iBox universal
01700180



Thermostat for concealed installation
with shut-off valve
11732, -000, -xxx

Basic set iBox universal
01700180



Thermostat for concealed installation
with shut-off/diverter valve
11733, -000, -xxx

Basic set iBox universal
01700180



Shut-off valve
for concealed installation
11960, -000, -xxx

Basic set 52 l/min spindle
16973180

Basic set 40 l/min ceramic
16974180

Basic set 130 l/min spindle
16970180



Shut-off/diverter valve Trio/Quattro
for concealed installation
11925, -000, -xxx

Basic set Trio
16982180

Basic set Quattro
16930180

Style fusion all the way to the bathtub

The floor-standing bathtub mixer, with its *eclectic* design, is at home anywhere in the bathroom. Just as *sensuous* as its counterpart on the wash basin, it fuses flat surfaces with unexpected *asymmetries*. When combined with the nostalgic look of the AXOR Urquiola bathtub, made of mineral casting material with a gel coating, it is a visual highlight in the bathroom.

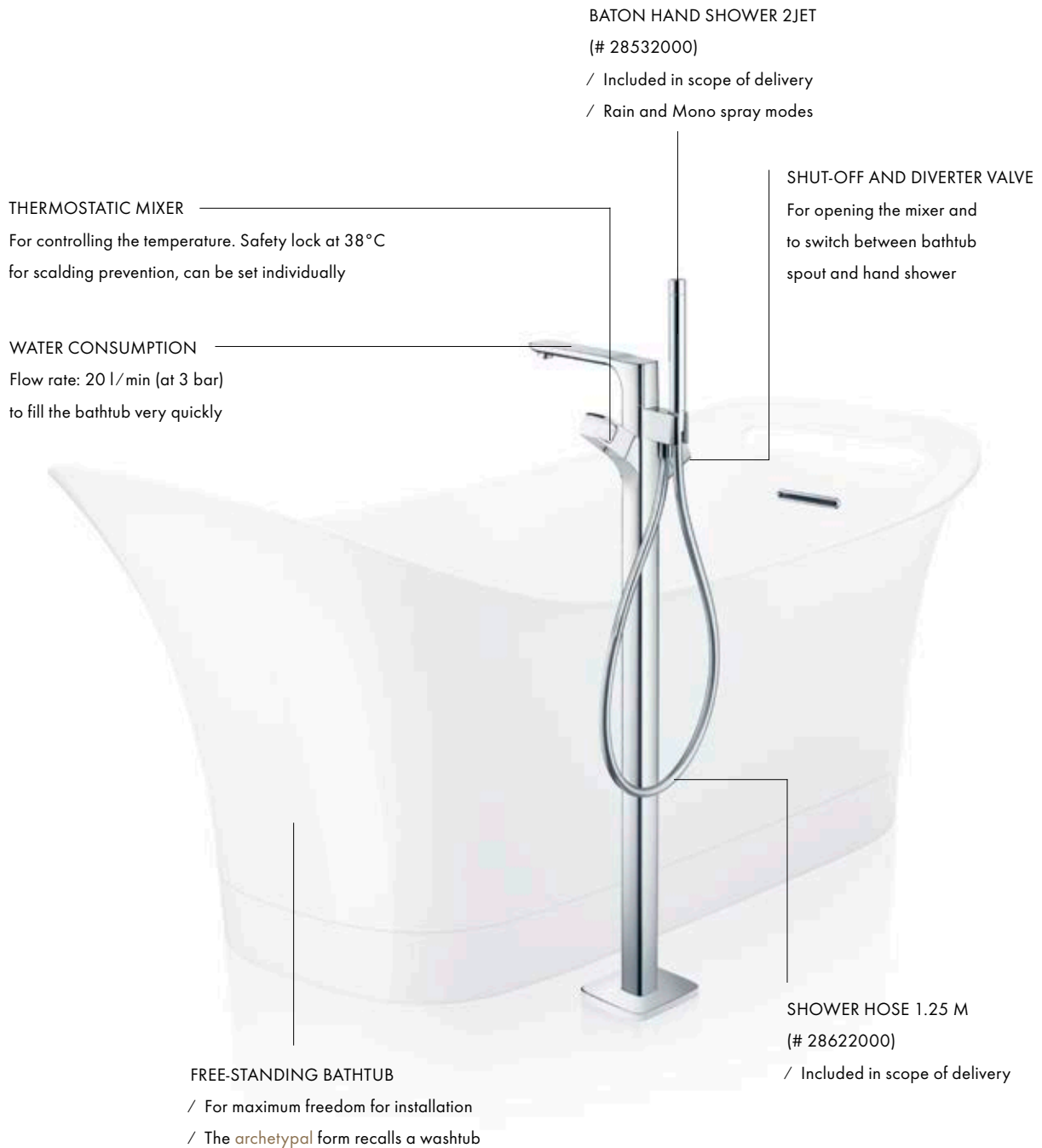



Bath thermostat floor-standing
11422, -000, -xxx

Basic set
10452180



/ Included in scope of delivery:
Baton hand shower 2jet
(# 28532, -000, -xxx)
Shower hose 1.25m
(# 28622, -000, -xxx)



Single lever bath mixer
for exposed installation
11420, -000, -xxx



/ Flow rate: 22 l/min (at 3 bar)



4-hole rim mounted bath mixer
11443, -000, -xxx

Installation plate
39449000

Basic set
15480180

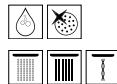

/ Included in scope of delivery: Hand shower
120 3jet (# 26050, -000, -xxx)



4-hole tile mounted bath mixer
11445, -000, -xxx

Basic set
15481180



3-hole rim mounted bath mixer
11436, -000, -xxx

Installation plate (not shown)
39449000

Basic set
15484180



Single lever bath mixer
for concealed installation
11425, -000, -xxx

Basic set iBox universal
01700180



Bath spout
11430, -000, -xxx



Bath tub 1,800/600
11440000

Technical data:

- / Material: mineral cast with gel coat
- / Filling capacity: approx. 180 l (1 person with 70 kg)
- / Weight with water (1 person with 70 kg): approx. 440 kg
- / Weight without water: 187 kg
- / Dimensions (l x w x d): 1,820 x 795 x 870 mm
- / Filling level: approx. 340 mm
- / Color: Alpinwhite



Finish set oval
28022, -000, -xxx

Finish set square (not shown)
28012, -000, -xxx

Basic set
15490180

- / sBox for quiet, smooth and safe hose guiding
- / Suitable for rim- or tile-mounted installation
- / Bath rim width at least 100 mm
- / Maximum pull-out length of individually selectable hand shower: 1.45 m



AXOR Massaud

The peace of nature

AXOR Massaud perfects the connection between people and nature. The collection makes water into a source of wellbeing and composure. Celebrates it in the form of a natural waterfall flowing from a shelf. The collection embodies uncompromising, *organic avant-garde design* inspired by the elements of nature. Far from all technology, to enjoy the moment – with water rather than with a mixer.

Design: Jean-Marie Massaud

“I WANTED TO MAKE THE
FUNCTIONAL ELEMENTS
DISAPPEAR TO CREATE
THE LANDSCAPE FOR A
HOLISTIC EXPERIENCE
WITH WATER.”

Jean-Marie Massaud

CHARACTERISTIC DESIGN FEATURE:

Organic design language inspired by nature: Expansive surfaces meet soft curves that transition to radical geometric forms. The body is a blade of grass. The cascading spray a *natural* waterfall.

125

THE DESIGNER'S IDEA:

The natural world and its elements: A sensuous waterfall flowing from a shelf – this is AXOR Massaud. The mixer is not a technical object. Rather, it was designed to present the element of water and create an ingenious connection between people and nature. To provide a source of calmness and contemplation.

SPECIAL COLLECTION HIGHLIGHTS:

- / The mixer gives added value as a shelf
- / *Avant-garde* water design: the cascading waterfall is not aerated – this nod to a natural waterfall resulted from intensive development work
- / Matching wash basins in organic design
- / The first collection in cooperation with Jean-Marie Massaud

Learn more about AXOR Massaud:

axor-design.com

Harmonious connection between natural aesthetics and modern design

AXOR Massaud brings the natural world into the bathroom, allowing us to experience the element of water in all its *sensual* glory. A vigorous stream gushes from the mixer like a waterfall. Behind this gorgeous cascade is advanced water-saving technology. All rounded out by the *harmonious* relation between the wash basin, with its organic form, and the mixer.

126

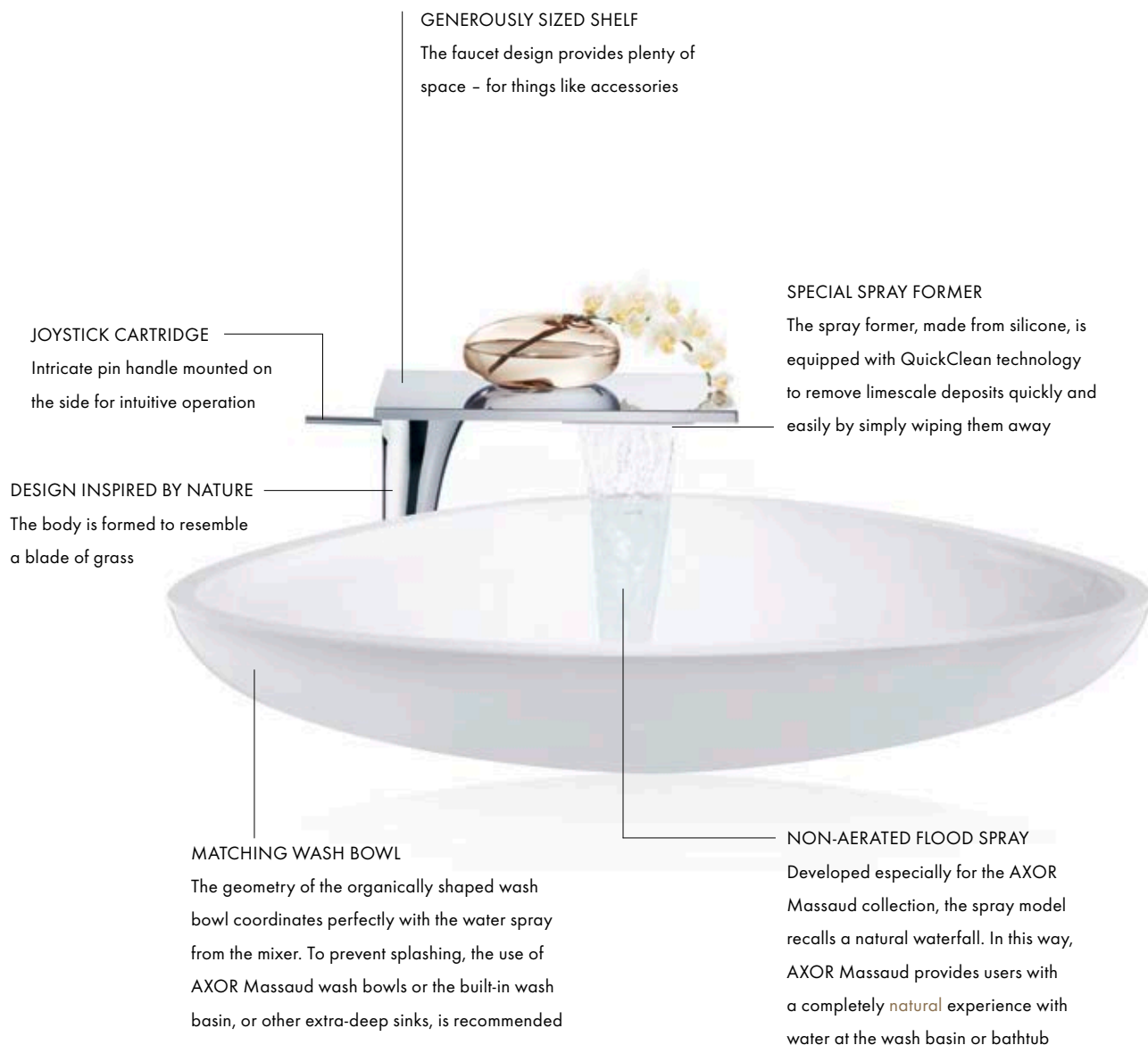

GENEROUSLY SIZED SHELF

The faucet design provides plenty of space - for things like accessories

SPECIAL SPRAY FORMER

The spray former, made from silicone, is equipped with QuickClean technology to remove limescale deposits quickly and easily by simply wiping them away

JOYSTICK CARTRIDGE

Intricate pin handle mounted on the side for intuitive operation

DESIGN INSPIRED BY NATURE

The body is formed to resemble a blade of grass

MATCHING WASH BOWL

The geometry of the organically shaped wash bowl coordinates perfectly with the water spray from the mixer. To prevent splashing, the use of AXOR Massaud wash bowls or the built-in wash basin, or other extra-deep sinks, is recommended

NON-AERATED FLOOD SPRAY

Developed especially for the AXOR Massaud collection, the spray model recalls a natural waterfall. In this way, AXOR Massaud provides users with a completely *natural* experience with water at the wash basin or bathtub

Wash basin



Single lever basin mixer 110
with waste set
18010000



/ Particularly suitable for
the built-in wash basin
of the AXOR Massaud
collection (# 42310000)



Single lever basin mixer 220
for wash bowls with waste set
18020, -000, -xxx



/ Particularly suitable for
free-standing wash bowls
of the AXOR Massaud
collection (# 42300000
and # 42305000)



Wash bowl 800/450
42300000



Wash bowl 570/450
42305000

/ Only in conjunction with basin mixers with non-closing waste set
/ Material: mineral cast with gel coat
/ TÜV certified

Bathtub



Single lever bath mixer floor-standing
18450, -000, -xxx

Basic set
10452180



/ Included in delivery: 2jet manual
shower (# 28532, -000, -xxx)
Metal effect shower hose
1.25 m (# 28282, -000, -xxx)



A perfect match: the floor-standing bathtub mixer with a non-aerated flood
spray that flows from the mixer into the tub like a **natural** waterfall.





AXOR Uno

The power of simplicity

AXOR Uno is about the **purity** of perfection. And about the simple shapes that form a visible design. Inspired by the original purists. The mixer consists of pipes – the original form of water transport – put together at precise right angles. Subtly excessive, based on the **golden ratio**. This ascetic form exudes a great strength. The power of simplicity.

Design: PHOENIX

“IMPLEMENTED
AT THE HIGHEST
TECHNOLOGICAL
LEVELS, AXOR UNO IS
THE QUINTESSENCE
OF PURISM: CLEAN,
MINIMALIST AND
SUBTLE.”

Andreas Diefenbach, PHOENIX

CHARACTERISTIC DESIGN FEATURE:

Purist mixer design: A clear **design** language with basic cylindrical forms. Precisely put together at right angles. Subtly excessive, based on the **golden ratio**.

THE DESIGNER'S IDEA:

An appreciation of design and material: With the pipe, one of the oldest forms of water transport, AXOR Uno embodies radical reduction to the essentials. The material and the design are the clear focus of the mixers.

SPECIAL COLLECTION HIGHLIGHTS:

- / Two design families and three handle variants: a **modern**, bow-shaped handle, a purist zero handle or a handle with Select technology
- / The design of the AXOR Uno 200 wash basin mixers is based on the principle of the golden ratio, a classic **proportional** relationship
- / The perfect addition to AXOR Uno in the shower: AXOR Showerpipe 800 – also rigorously **purist in design**
- / **AXOR FinishPlus** surface in Brushed Nickel is available ex stock
- / AXOR Uno is a redesign of the successful AXOR Uno collection introduced in 1985

Purism. Without exception

The two design families of the AXOR Uno collection embody **purism** in different versions. Characteristic of all of the products are clear lines and cylinders put together at precise right angles. With handle variants such as the bow-shaped handle, the zero handle or the handle with Select technology, maximum **ergonomics** meets **minimalist** design.

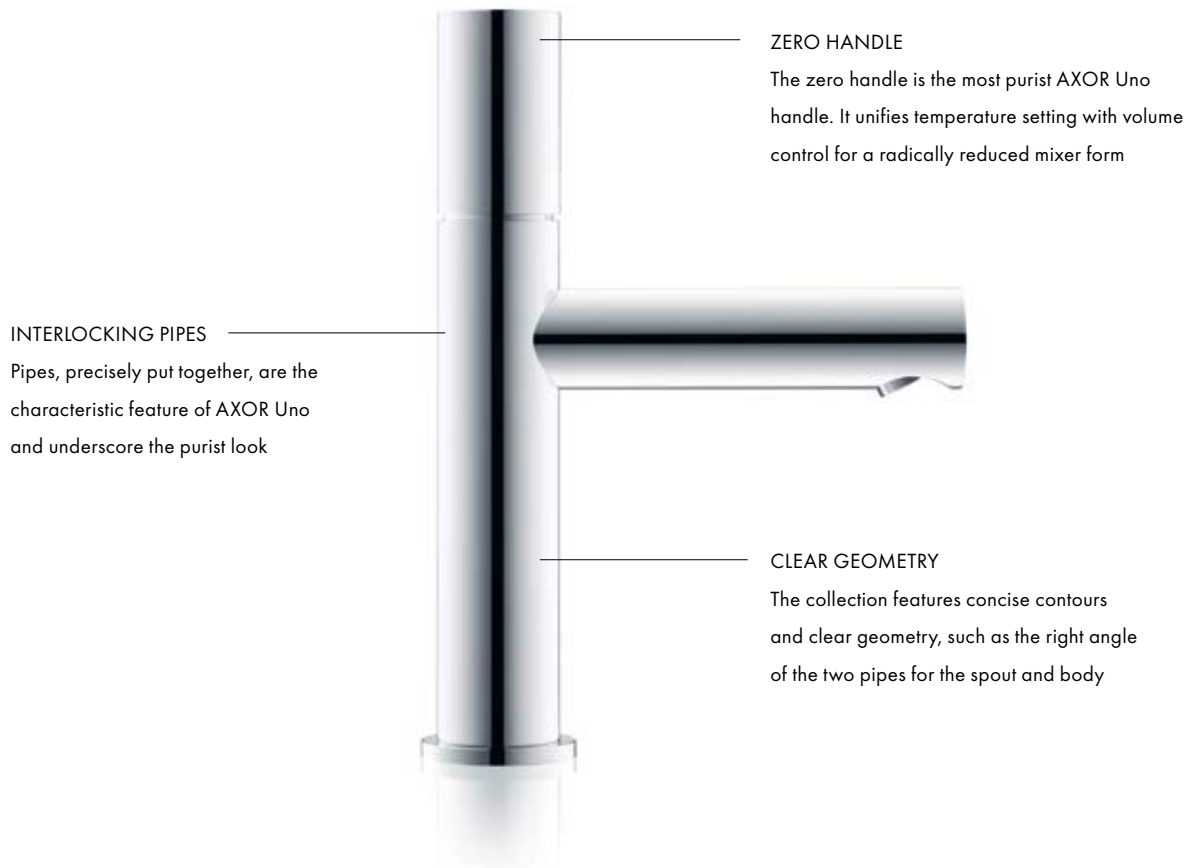

ZERO HANDLE
The zero handle is the most purist AXOR Uno handle. It unifies temperature setting with volume control for a radically reduced mixer form

INTERLOCKING PIPES
Pipes, precisely put together, are the characteristic feature of AXOR Uno and underscore the purist look

CLEAR GEOMETRY
The collection features concise contours and clear geometry, such as the right angle of the two pipes for the spout and body

130



BOW-SHAPED HANDLE
The bow-shaped handle offers especially ergonomic operation.



SELECT BUTTON
The Select button is an intuitive control element.

Wash basin Zero



Single lever basin mixer 80 with zero handle and waste set # 45005, -000, -xxx



Single lever basin mixer 110 with zero handle with pop-up waste set # 45001, -000, -xxx

with zero handle and waste set (not shown) # 45002, -000, -xxx



Single lever basin mixer 200 with zero handle and waste set # 45003, -000, -xxx



Single lever basin mixer 260 with zero handle and waste set # 45004, -000, -xxx



3-hole basin mixer 200 with zero handles and pop-up waste set # 45133, -000, -xxx



Single lever basin mixer for concealed installation wall-mounted with spout 165 mm and plate # 38112, -000, -xxx

with spout 225 mm and plate (not shown) # 38115, -000, -xxx

Basic set # 13623180



Single lever basin mixer for concealed installation wall-mounted with spout 165 mm and escutcheons # 38113, -000, -xxx

with spout 225 mm and escutcheons (not shown) # 38116, -000, -xxx

Basic set # 13623180



Single lever basin mixer floor-standing with zero handle without waste set # 45037, -000, -xxx

Basic set # 10452180



Pillar tap 70 without waste set # 38130, -000, -xxx



Wash basin Select



Basin mixer Select 80
with waste set
45015, -000, -xxx



Basin mixer Select 110
with pop-up waste set
45010, -000, -xxx
with waste set (not shown)
45012, -000, -xxx



Basin mixer Select 200
with waste set
45013, -000, -xxx



Basin mixer Select 260
with waste set
45014, -000, -xxx



Basin mixer Select 220
with pop-up waste set
45016, -000, -xxx



/ Separation of temperature control and on/off



Pillar tap Select 80
without waste set
45130, -000, -xxx



Basin mixer for concealed installation
wall-mounted Select
with spout 158 mm
45112, -000, -xxx
with spout 221 mm (not shown)
45113, -000, -xxx

Basic set
13623180



/ Separation of temperature control and on/off

132

Wash basin Loop handle



Single lever basin mixer 70
with loop handle and waste set
38021, -000, -xxx



Single lever basin mixer 100
with loop handle
and pop-up waste set
38023, -000, -xxx
with waste set (not shown)
38026, -000, -xxx



Single lever basin mixer 190
with loop handle and waste set
38032, -000, -xxx



Single lever basin mixer 250
with loop handle and waste set
38034, -000, -xxx



Wash basin Loop handle



Single lever basin mixer
floor-standing
with loop handle
without waste set
38037, -000, -xxx

Basic set
10452180



Single lever basin mixer 240
with loop handle
and pop-up waste set
38036, -000, -xxx



3-hole basin mixer 160
with loop handles
and pop-up waste set
38054, -000, -xxx



Single lever basin mixer
for concealed installation
wall-mounted with loop handle
and spout 165 mm
38121, -000, -xxx
with spout 225 mm (not shown)
38122, -000, -xxx

Basic set
13623180



Electronic



Electronic basin mixer
for concealed installation
wall-mounted with spout 161 mm
45110, -000, -xxx

with spout 221 mm (not shown)
45111, -000, -xxx

Basic set
16180180



Electronic basin mixer
with temperature pre-adjustment
with mains connection 230 V
38010, -000, -670, -xxx

Basic set
16182180



/ Due to technical reasons
this product is not available
in the surface finishes Red
Gold and Black Chrome



Electronic basin mixer
for concealed installation
wall-mounted with spout 225 mm
38120, -000, -670, -xxx

with spout 165 mm (not shown)
38119, -000, -670, -xxx

Basic set
16180180



133

Bidet



Single lever bidet mixer
with zero handle
and pop-up waste set
45200, -000, -xxx



Bidet mixer Select
with pop-up waste set
45210, -000, -xxx



Single lever bidet mixer
with loop handle
and pop-up waste set
38211, -000, -xxx



Perfect purism in shower design

The AXOR Showerpipe 800 provides an integrated system solution, consisting of a thermostatic mixer, overhead shower and hand shower, all in the **purist** pipework design of the AXOR Uno collection. Select technology makes the Showerpipe with its integrated AXOR overhead shower 350 1jet and innovative PowderRain spray mode easy to operate.

AXOR OVERHEAD SHOWER 350 1JET

- / Overhead shower made of pure, high-quality metal
- / Maximum flexibility with a shower arm that swivels 70°
- / The innovative PowderRain spray mode envelops the body in a cocoon of velvety softness
- / With the QuickClean functionFlow rate: 22 l/min (at 3 bar)



AXOR BATON HAND SHOWER 2JET

- / Spray modes: Rain, Mono
- / Positioned in a high-quality, height-adjustable metal slider. Angle can be adjusted in a range of 90°. Swivels left/right and up/down



SHOWER HOSE WITH VOLUME CONTROL

- Makes it easy to adjust the water flow for the baton hand shower 2jet



AXOR THERMOSTATIC MIXER 800

Perfectly integrated into the product design with a generously sized shelf surface made of sturdy safety glass

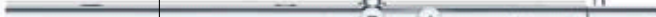

TEMPERATURE CONTROL

- / With integrated safety lock at 40°C
- / Hot water limiter can be set individually

SELECT BUTTONS

- / For intuitive, user-friendly outlet control with clear function assignment
- / Two outlets (overhead shower and hand shower) can be used simultaneously

Showerpipe with thermostat 800 and overhead shower 350 1jet # 27984, -000, -xxx



Shower



Thermostat 800
for exposed/concealed installation
45440, -000, -xxx



Shower thermostat
for exposed installation
34635, -000, -xxx



Thermostat HighFlow
for concealed installation
38715, -000, -xxx

Basic set iBox universal
01700180

/ Due to technical reasons this product is not available in the surface finishes Polished and Brushed Bronze



Thermostat for concealed installation
with shut-off valve
38700, -000, -xxx

with shut-off/diverter valve
(not shown)
38720, -000, -xxx

Basic set iBox universal
01700180

/ This product is available in the surface finishes Polished and Brushed Bronze only via AXOR Signature inquiry



Shut-off valve
for concealed installation
38976, -000, -xxx

Basic set 52 l/min spindle
16973180

Basic set 40 l/min ceramic
16974180

Basic set 130 l/min spindle
16970180



Shut-off/diverter valve Trio/Quattro
for concealed installation
38933, -000, -xxx

Basic set Trio
16982180

Basic set Quattro
16930180



Wall outlet stop with shut-off valve
38882, -000, -xxx

135

Shower Zero/Select

Shower Loop handle



Single lever shower mixer
for concealed installation
with zero handle
45605, -000, -xxx

Basic set iBox universal
01700180



Single lever shower mixer
for exposed installation
with zero handle
45600, -000, -xxx



Single lever shower mixer
for concealed installation
with loop handle
38626, -000, -xxx

Basic set iBox universal
01700180



Single lever shower mixer
for exposed installation
with loop handle
38621, -000, -xxx

Bath tub Loop handle



Single lever bath mixer floor-standing with loop handle # 38442, -000, -xxx

Basic set # 10452180



Bath spout curved floor-standing # 38412, -000, -670, -xxx

Basic set # 10452180



4-hole rim mounted bath mixer with loop handles # 38445, -000, -xxx

Basic set # 15480180



3-hole rim mounted bath mixer with loop handle # 38436, -000, -xxx

Basic set # 15485180



Single lever bath mixer for exposed installation with loop handle # 38421, -000, -xxx



Bath spout curved # 38411, -000, -670, -xxx



136



Single lever bath mixer for concealed installation with loop handle # 38426, -000, -xxx

with integrated security combination according to EN1717 (not shown) # 38428, -000, -xxx

Basic set iBox universal # 01700180



For the three-hole rim-mounted bath mixer with loop handle (# 38436000), the hand shower 120 3jet (# 26050000) is included in the scope of delivery.



Single lever bath mixer floor-standing with zero handle
45416, -000, -xxx
Basic set
10452180



Bath spout straight floor-standing
45412, -000, -xxx
Basic set
10452180



4-hole rim mounted bath mixer with zero handles
45444, -000, -xxx
Basic set
15480180



Bath spout straight
45410, -000, -xxx



Single lever bath mixer for concealed installation with zero handle
45405, -000, -xxx
with integrated security combination according to EN1717 (not shown)
45407, -000, -xxx
Basic set iBox universal
01700180



Bath thermostat 800 for exposed installation
45420, -000, -xxx
Bath thermostat 1200 for exposed installation (not shown)
45421, -000, -xxx



2-hole rim mounted thermostatic bath mixer
38480, -000, -xxx
Basic set
15486180



Finish set oval
28022, -000, -xxx
Finish set square (not shown)
28012, -000, -xxx
Basic set
15490180

- / sBox for quiet, smooth and safe hose guiding
- / Suitable for rim- or tile-mounted installation
- / Bath rim width at least 100 mm
- / Maximum pull-out length of individually selectable hand shower: 1.45 m



A special bathroom highlight is the floor-standing bath spout (# 45412 -000, -xxx) in combination with thermostatic module Select for 2 functions (# 18355, -000, -xxx).



AXOR Montreux

The tradition of industrial design

The AXOR Montreux mixer collection is modelled on the first industrially produced mixers from around the turn of the last century. The Belle Époque era symbolizes a time of fundamental change and technical progress. Immortalized in Europe's grand hotels and in Montreux, the legendary spa resort on the shores of Lake Geneva. AXOR Montreux combines outstanding technology with modern functionality.

Design: PHOENIX

“AXOR MONTREUX
REINTERPRETS THE
FEATURES OF THE EARLY
20TH CENTURY WITH
GREAT PRECISION
AND WORKMANSHIP,
OFFERING USERS THE
BEST IN DESIGN AND
FUNCTIONALITY.”

Andreas Haug, PHOENIX

CHARACTERISTIC DESIGN FEATURE:

Classic, authentic bathroom design: AXOR Montreux is a modern reinterpretation of industrial design with couplings, valves and pipes. Additive design elements for a richly detailed look.

THE DESIGNER'S IDEA:

Authentic aesthetics: AXOR Montreux is an authentic, historical journey back in time to the heady days of industrialization. The collection combines the design of the first industrially manufactured mixers from the turn of the last century with outstanding technology and modern functionality, bringing the Belle Époque into the 21st century.

SPECIAL COLLECTION HIGHLIGHTS:

- / Two handle variants: **classic** with cross handles, **modern** reinterpretation with lever handles
- / Various spout heights for wash basin mixers
- / The bridge mixer: A classic three-hole variant
- / Particular attention to detail: Porcelain inlays – with individualized inscriptions by request
- / Perfect for an overall classic atmosphere and for classic accents in a modern atmosphere
- / 2016: AXOR Montreux collection of 2006 expanded to include single lever mixer and lever handle variants

Learn more about AXOR Montreux:

axor-design.com

Additive design in the tradition of the industrial age

AXOR Montreux pays homage to the Belle Époque. Along with wash basin mixers, it offers products for every bathroom area. The collection includes classic versions with low spouts and modern reinterpretations with high spouts. Choose from cross handles or lever handles.

140

AUTHENTIC HOT/COLD INSCRIPTIONS
High quality porcelain plates inscribed with Hot/Cold labels. The AXOR Signature Service offers personalization

HISTORICAL „BRIDGE MIXER“
A three-hole wash basin mixer that pays homage to the Belle Époque

SWIVEL SPOUT
A high spout that swivels in a range of 120° for a modern look and maximum freedom of movement at the wash basin

HANDLE VARIANTS
Cross handles are the traditional version, modelled on early industrial design. Lever handles provide a modern contrast

ADDITIVE DESIGN
Characterized by the use of early industrial design elements such as couplings, valves and pipes

WASTE SET
With uncompromising traditional design



Wash basin



Single lever basin mixer 100
with lever handle
and pop-up waste set
16515, -000, -xxx

with waste set (not shown)
16516, -000, -xxx



Single lever basin mixer 210
with lever handle
and pop-up waste set
16517, -000, -xxx

with waste set (not shown)
16518, -000, -xxx



2-handle basin mixer 210
with cross handles
and pop-up waste set
16502, -000, -xxx

with waste set (not shown)
16506, -000, -xxx



2-handle basin mixer 160
with cross handles for hand wash
basins with pop-up waste set
16505, -000, -xxx



2-handle basin mixer 220
with cross handles
and pop-up waste set
16510, -000, -xxx



2-handle basin mixer 220
with lever handles
and pop-up waste set
16511, -000, -xxx



3-hole basin mixer 180
with cross handles
and pop-up waste set
16513, -000, -xxx



3-hole basin mixer 180
with lever handles
and pop-up waste set
16514, -000, -xxx



3-hole basin mixer 30
with cross handles
and pop-up waste set
16536, -000, -xxx
with lever handles (not shown)
16535, -000, -xxx



3-hole basin mixer
for concealed installation
wall-mounted with spout 165-225 mm
and cross handles
16532, -000, -xxx

with lever handles (not shown)
16534, -000, -xxx

Basic set
10303180



/ Spout can be shortened
individually by cutting
the joined pipe (variable
length 165-225 mm)



Pillar tap 50
with lever handle
without waste set
16530, -000, -xxx



Single lever bidet mixer
with lever handle
and pop-up waste set
16526, -000, -xxx
with cross handle (not shown)
16520, -000, -xxx

Bidet



Shower cross handles



2-handle shower mixer
for exposed installation
with cross handles
16560, -000, -xxx



Shower thermostat
for exposed installation
with cross handle
16261, -000, -xxx



Thermostat HighFlow
for concealed installation
with cross handle
16815, -000, -xxx

Basic set iBox universal
01700180



Thermostat for concealed installation
with cross handle and shut-off valve
16800, -000, -xxx

Basic set iBox universal
01700180



Thermostat for concealed installation
with cross handle
and shut-off/diverter valve
16820, -000, -xxx

Basic set iBox universal
01700180



Shut-off/diverter valve Trio/Quattro
for concealed installation
with cross handle
16830, -000, -xxx

Basic set Trio
16982180

Basic set Quattro
16930180



Shut-off valve
for concealed installation
with cross handle
16871, -000, -xxx

Basic set 52 l/min spindle
16973180

Basic set 40 l/min ceramic
16974180

Basic set 130 l/min spindle
16970180



Wall outlet stop with non return valve,
shut-off valve and cross handle
16882, -000, -xxx



Modern functionality – authentic in design

Authentic showering. The AXOR Montreux Showerpipe. Externally: Belle Époque. Internally: State of the art. With cutting-edge thermostat technology. And clearly separate control units for overhead and hand showers. Committed to technological advancement. Just like the era of the Belle Époque.



Shower lever handles



Showerpipe with thermostat and overhead shower 240 ljet
16572, -000, -xxx



Thermostat HighFlow for concealed installation with lever handle
16824, -000, -xxx

Basic set iBox universal
01700180



Thermostat for concealed installation with lever handle and shut-off valve
16801, -000, -xxx

with shut-off/diverter valve (not shown)
16821, -000, -xxx

Basic set iBox universal
01700180



Shower thermostat for exposed installation with cross handle
16261, -000, -xxx



Shut-off valve for concealed installation with lever handle
16872, -000, -xxx

Basic set 52 l/min spindle
16973180

Basic set 40 l/min ceramic
16974180

Basic set 130 l/min spindle
16970180



Wall outlet stop with non return valve, shut-off valve and lever handle
16883, -000, -xxx



Wall outlet with non-return valve
16884, -000, -xxx



Overhead shower 240 ljet Classic
28474, -000, -xxx

Overhead shower 180 ljet Classic (not shown)
28487, -000, -xxx



Combinable with:
/ Shower arm 389 mm
(# 27348, -000, -820, -xxx)
/ Ceiling connection 100 mm
(# 26432, -000, -820, -xxx)
/ Ceiling connection 300 mm
(# 26433, -000, -820, -xxx)



Shower set 0.90 m with hand shower 100 ljet
27982, -000, -xxx



Hand shower 100 ljet
16320, -000, -xxx



Optional parts:
/ Metal shower hose, 1.25 m
(#28112, -000, -xxx)
/ Metal shower hose, 1.60 m
(#28116, -000, -xxx)
/ Metal shower hose, 2.00 m
(#28120, -000, -xxx)



Shower holder
16325, -000, -xxx

/ For shower hoses with conical nuts

Classic design for the bathtub

The AXOR Montreux collection includes a broad spectrum of products for the bathtub to cover a variety of spatial requirements. From the two-handle bath mixer for exposed installation to the four-hole rim- or tile-mounted bath mixer, the products in the collection are available with either cross handles or lever handles. A real eye-catcher – the floor-standing bath mixer. In combination with a free-standing bathtub, it offers an extra degree of flexibility in bathroom design.

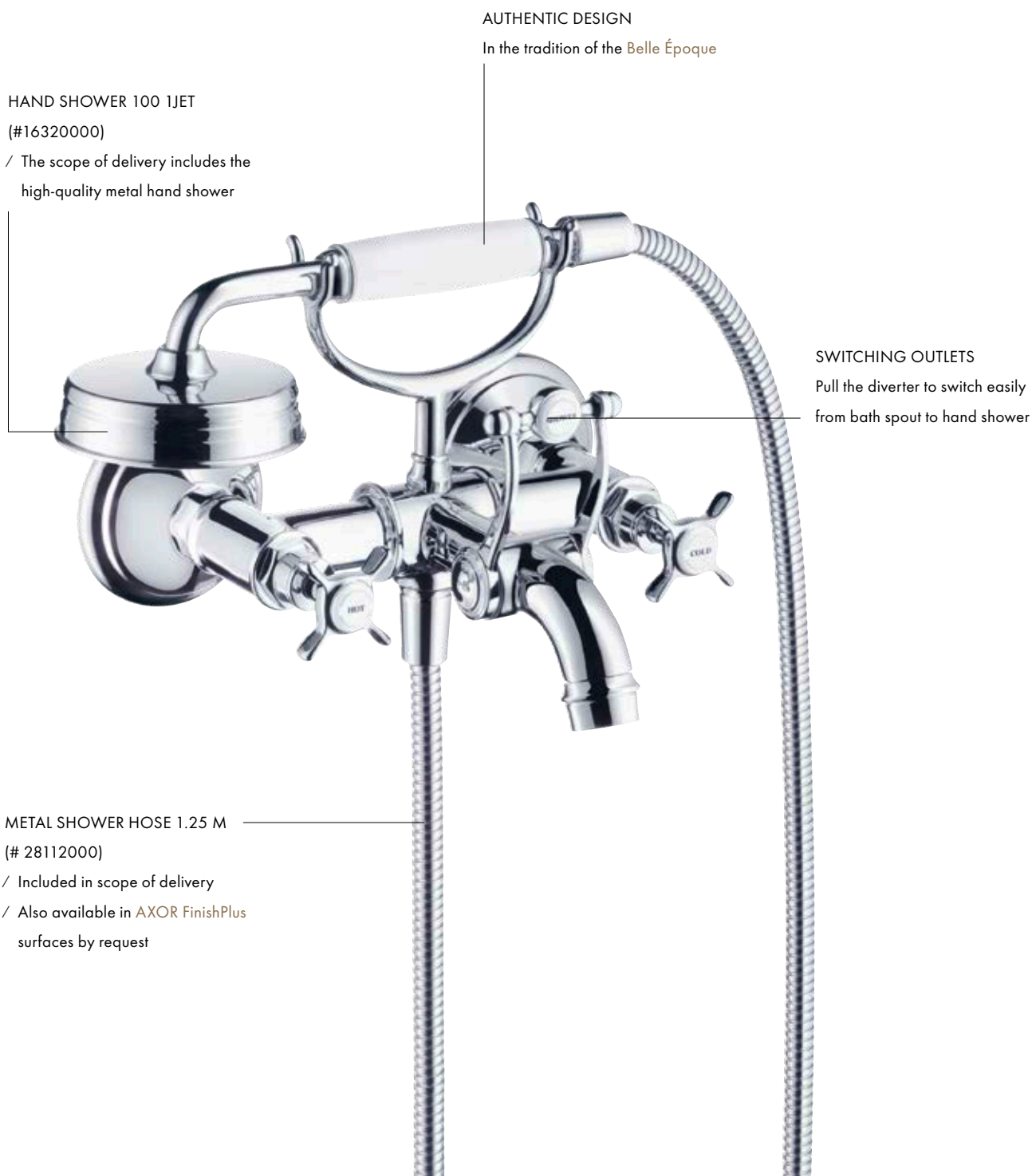

Bath tub cross handles



2-handle bath mixer
for exposed installation
with cross handles
16540, -000, -xxx



4-hole rim mounted bath mixer
with cross handles
16546, -000, -xxx

Basic set
15480180



4-hole tile mounted bath mixer
with cross handles
16544, -000, -xxx

Basic set
15481180



Bath tub lever handles

2-handle bath mixer
floor-standing with cross handles
16547, -000, -xxx

Basic set
16549180

Sealing foil for basic set
96441000



Bath spout
16541, -000, -xxx



/ Spout can be shortened
individually by cutting
the joined pipe (variable
length 166-220 mm)



2-handle bath mixer
for exposed installation
with lever handles
16551, -000, -xxx



4-hole rim mounted bath mixer
with lever handles
16550, -000, -xxx

Basic set
15480180



4-hole tile mounted bath mixer
with lever handles
16554, -000, -xxx

Basic set
15481180



AXOR Programs

The products from the AXOR programs are the perfect complement to the AXOR collections, and can equip a complete AXOR bathroom. They include generic shower products for the shower, **accessories** for the bathroom and kitchen, and select electronic faucets in various styles. Each product is a unique design object in its own right. The technical complement in the wall: matching basic sets for different installation variants.

AXOR SHOWERS
Excellence in the shower

150



AXOR ACCESSOIRES
Highest expression of individual style

176

AXOR ELECTRONIC
Non-contact Design mixers

194



AXOR BASE SETS, INLET,
DRAIN, AND OVERFLOW SETS
Technology with a system

198



AXOR Showers

Excellence in the shower

Three features distinguish the various AXOR shower products: All are *luxurious* design objects, shape the space definitively and provide fascinating experiences of water. AXOR Showers impart a sense of appreciation for water and for the body

Design: Philippe Starck, PHOENIX, Nendo, Front, Barber Osgerby

AXOR SHOWER
PRODUCTS REPRESENT
DESIGN, INNOVATION
AND WATER EXPERIENCES
AT THE HIGHEST LEVEL.

CHARACTERISTIC DESIGN FEATURE:

Avant-garde design objects with universal appeal – for combinations across different collections.

THE DESIGNERS' IDEA:

Luxury in the shower: AXOR Showers offer fascinating *design*, perfect function and a one-of-a-kind water experience. The user is the focus of the luxurious physical experience provided by an AXOR Shower.

SPECIAL PROGRAM HIGHLIGHTS:

- / AXOR ShowerHeaven 1200/300 4jet:
Large dimensions and the innovative PowderRain spray mode impart a spa feel
- / AXOR ShowerCollection: A *modular* system consisting of overhead showers, shower modules, thermostatic mixers, valves and shelves
- / AXOR LampShower designed by Nendo:
A source of light and water
- / AXOR Showerpipe designed by Front: An object in *authentic* industrial design language
- / AXOR One thermostatic mixers: Innovative control and easy to use thanks to Select technology
- / Wide variety of spray modes for various applications:
From invigorating to massaging to softly enveloping

Learn more about AXOR Showers:

axor-design.com

Spray innovation in the shower

The AXOR ShowerHeaven 1200/300 4jet is a new **archetype** in the shower, offering a grand stage for water. Here, it is staged in an extraordinary way: with a revitalizing water jet, a soothing rain shower, all the way up to the gentle PowderRain – the AXOR innovation in water design. Here, countless velvety-soft water droplets envelop the body like a cocoon of water.

EXTENSION SET

- / The optional extension set (# 13603000) makes the product appear to float, providing a sense of weightlessness

OPTIONAL LIGHTING

- / Indirect light
- / Energy-efficient LED illuminant (5 W in 3,500 K version)
- / Power supply: Input voltage 100–240 V AC, 50–60 Hz/output voltage 24 V DC
- / Color temperature warm white 2,700 K or neutral white 3,500 K
- / 125 lm/W light output
- / Including 7 m connection cable
- / Lighting controlled by a separate switch outside the shower

RAIN JET

- / Shower rain that surrounds the whole body
- / Geometric spray field, perfectly adapted to the user's body
- / Spray field, 460 mm in width
- / With QuickClean function
- / Flow rate: 16 l/min (at 3 bar)

MECHANICAL WINGS

- / Movable flaps that open under water pressure
- / Body jet can be angled to suit different user heights
- / When not in use, the flaps close to form a flat, easy to clean surface

MONO JET

- / Concentrated, soothing, relaxing jet for a real spa feeling
- / Flow rate: 15 l/min (at 3 bar)

POWDERRAIN BODY SPRAY

- / Velvety soft shower rain
- / Can be set to leave the head dry
- / Inside and outside flaps controlled separately
- / With QuickClean function
- / Flow rate: approx. 15 l/min (at 3 bar)

USING THE RESOURCE OF WATER WISELY

- / Flow rate: max. 30 l/min (at 3 bar) if all outlets are used simultaneously
- / Water supply assisted with DN15 standard connection

Overhead showers



ShowerHeaven 1200/300 4jet
with lighting 2700 K
10628, -000, -xxx
with lighting 3500 K (not shown)
10629, -000, -xxx
without lighting (not shown)
10637, -000, -xxx
Basic set
10922180



/ Optional part:
Extension set 230 mm
for ceiling connector (#
13603, -000, -xxx)
/ Due to technical reasons
this product is not available
in Polished and Brushed
Black Chrome

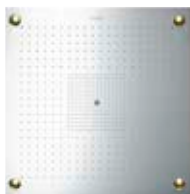

ShowerHeaven 970/970 3jet
with lighting
10623800
without lighting (not shown)
10621800

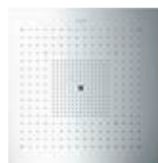

ShowerHeaven 720/720 3jet
with lighting
10625800
without lighting (not shown)
with lighting (not shown)
10627800



/ Installation possibilities: Ceiling-flush or ceiling-exposed



Overhead shower 250/580 3jet
35283, -000, -xxx
Basic set iBox universal
01700180



Overhead shower 460/300 3jet
with shower arm and square
escutcheon
35282, -000, -xxx
with softsquare escutcheon
(not shown)
35276, -000, -xxx
Basic set iBox universal
01700180



Overhead shower 460/300 2jet
with shower arm and square
escutcheon
35280, -000, -xxx
with softsquare escutcheon
(not shown)
35275, -000, -xxx
Basic set iBox universal
01700180



Overhead shower 460/300 1jet
with shower arm and square
escutcheon
35278, -000, -xxx
with softsquare escutcheon
(not shown)
35274, -000, -xxx



Overhead shower 460/300 3jet
with ceiling connection
35281, -000, -xxx
Basic set
26434180



Overhead shower 460/300 2jet
with ceiling connection
35279, -000, -xxx
Basic set
26434180



Overhead shower 460/300 1jet
with ceiling connection
35277, -000, -xxx
Basic set
26434180



Overhead shower 350 1jet
with shower arm
26034, -000, -xxx
with ceiling connection (not shown)
26035, -000, -xxx



Purist design combined with a fascinating water experience in the shower

Purist design – based on the circle and square – characterizes the circular version of the AXOR overhead showers with diameters of 250 mm and 300 mm and the square versions of 250/250 mm and 300/300 mm. All versions are made for universal use and are compatible with every luxury shower design. Clear geometric forms with flat surfaces are the style-defining element throughout – from the spray disc to the ceiling or wall cover plate. Made of high-quality metal – with a bright Chrome surface or finished with one of the many special AXOR FinishPlus surfaces – the showers are perfect design elements for the bathroom. Inside: a technical masterpiece. The specially developed spray nozzles only become visible when the water is on and disappear again when the shower is switched off. This technology is based on water pressure and functions without any additional mechanism.

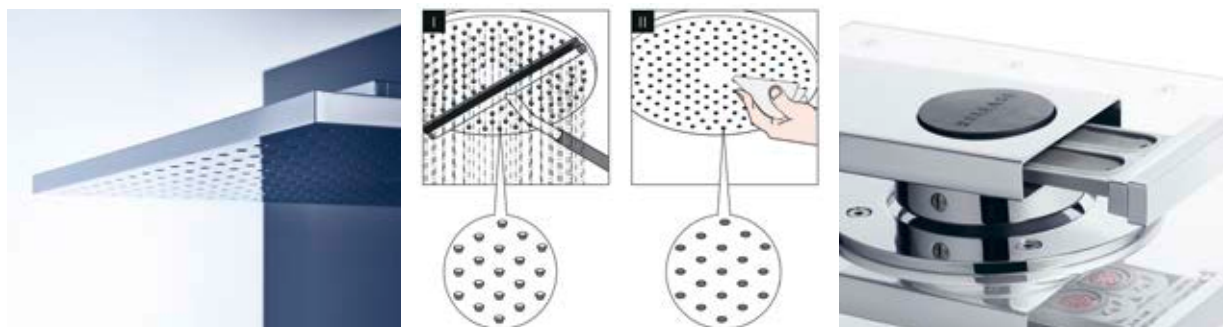

154

The dynamic spray nozzles emphasize the purist design of the high-quality metal spray disc. Because the disc has a flat surface without silicone naps, water droplets and limescale deposits can be easily removed from the spray disc with a towel or squeegee scraper. Thanks to the QuickClean function, limescale deposits can be simply wiped from the silicone naps. The bayonet connection allows the shower head to be easily removed, e.g. to be placed in solution to remove calcium deposits.

The integrated ServiceCard contains the shower filters. No tools are required to remove the overhead shower to clean the filters because the ServiceCard allows simple, efficient access to them. This makes necessary occasional maintenance more efficient and saves operating costs.



PowderRain

Intense PowderRain

PowderRain + Intense PowderRain

Innovative PowderRain and Intense PowderRain spray modes: PowderRain provides a fine rain shower (flow rate: 16-20 l/min at 3 bar) that feels like an enveloping cocoon of water. Or Intense PowderRain – a powerful spray jet (flow rate: 15-18 l/min at 3 bar) and a true innovation among the 2jet versions.

Overhead showers



Overhead shower 300 2jet
with shower arm
35303, -000, -670, -xxx



Basic set 2jet
35361180

1jet with shower arm (not shown)
35300, -000, -670, -xxx



/ Optional accessories: Softsquare escutcheon # 35214XXX



Overhead shower 250 2jet
with shower arm
35296, -000, -xxx



Basic set 2jet
35361180

1jet with shower arm (not shown)
35284, -000, -xxx



Overhead shower 300 2jet
with ceiling connection
35304, -000, -670, -xxx



1jet with ceiling connection
(not shown)
35301, -000, -670, -xxx



Basic set for overhead shower
with ceiling connector
26434180



Overhead shower 250 2jet
with ceiling connection
35297, -000, -xxx



1jet with ceiling connection
(not shown)
35286, -000, -xxx



Basic set for overhead shower
with ceiling connector
26434180



Overhead shower 300 2jet
ceiling-exposed
35305, -000, -670, -xxx



1jet ceiling-exposed (not shown)
35302, -000, -670, -xxx



Basic set for overhead shower
ceiling-exposed
35363180



Overhead shower 250 2jet
ceiling-exposed
35298, -000, -xxx



1jet ceiling-exposed (not shown)
35287, -000, -xxx



Basic set for overhead shower
ceiling-exposed
35363180



Overhead shower 300/300 2jet
with shower arm
35318, -000, -xxx



Basic set 2jet
35361180

1jet with shower arm (not shown)
35314, -000, -xxx



/ Optional accessories: Softsquare escutcheon # 35214XXX



Overhead shower 250/250 2jet
with shower arm
35310, -000, -xxx



Basic set 2jet
35361180

1jet with shower arm (not shown)
35306, -000, -xxx



Overhead shower 300/300 2jet
with ceiling connection
35320, -000, -xxx



1jet with ceiling connection
(not shown)
35316, -000, -xxx



Basic set for overhead shower
with ceiling connector
26434180



Overhead shower 250/250 2jet
with ceiling connection
35312, -000, -xxx



1jet with ceiling connection
(not shown)
35308, -000, -xxx



Basic set
26434180



Overhead shower 300/300 2jet
ceiling-exposed
35321, -000, -xxx



1jet ceiling-exposed (not shown)
35317, -000, -xxx



Basic set for overhead shower
ceiling-exposed
35363180



Overhead shower 250/250 2jet
ceiling-exposed
35313, -000, -xxx



1jet ceiling-exposed (not shown)
35309, -000, -xxx



Basic set for overhead shower
ceiling-exposed
35363180

A source of light and water

The AXOR LampShower designed by Nendo integrates lighting with the shower to form an exclusive design object. The integrated lighting blurs the lines that normally divide a space to bring a sense of coziness to the shower. A wide wreath of rain completely surrounds the body with water.

SPRAY DISC

- / Made of pure metal
- / Diameter 275 mm
- / Can be removed for easy cleaning

LIGHTING

- / Energy-efficient LED illuminant (4 W)
- / Power supply: Input voltage 100-240 V AC, 50-60 Hz/output voltage 12 V DC
- / Incl. power supply unit 12 V, 12 W
- / Color temperature warm white 2,700 K
- / Power supply: 7 m connection cable with power supply unit 12 V
- / Lighting controlled by a separate switch outside the shower

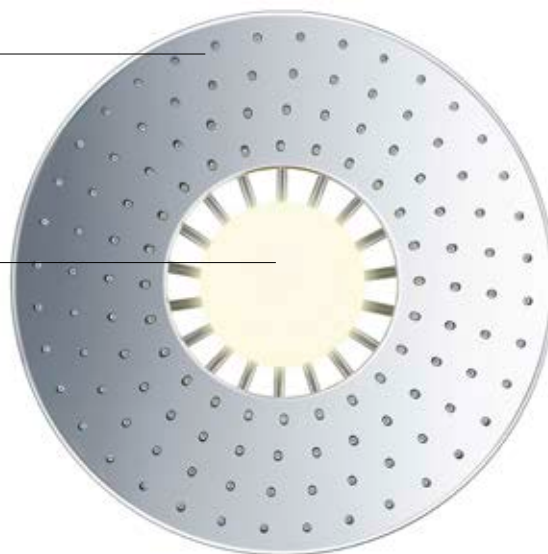

156

SHOWER ARM

- / Length 380 mm, can swivel horizontally in a range of 150°
- / Perfect shower jet alignment

BALL JOINT

- / Can be adjusted by 5° for the ideal spray direction

SPRAY MODE

- / Gentle rain jet for an exceptional shower experience
- / With QuickClean function
- / Flow rate: 13 l/min (at 3 bar)



Kopfbrausen



Overhead shower 240/240 1jet with shower arm
10925, -000, -xxx

Basic set
10921180



/ Spray disc removable for cleaning



Overhead shower 240/240 1jet with ceiling connection
10929, -000, -xxx



Overhead shower 240/240 1jet ceiling-exposed
10924, -000, -xxx



Flood spout 240/120 for concealed installation
10942, -000, -xxx



/ Can be used as bath spout or flood shower



LampShower 275 1jet with ceiling connector
26032, -000, -xxx



LampShower 275 1jet with shower arm
26031, -000, -xxx

Basic set
26909180



Overhead shower 240 2jet with ceiling connector
26022, -000, -xxx



Overhead shower 240 2jet with shower arm
26021, -000, -xxx

Basic set
26909180



/ Spray modes can be changed by pushing the Select button which is integrated in the spray disc



Overhead shower 280 2jet with shower arm
48492, -000, -670, -xxx

Basic set 2jet
35361180



Overhead shower 280 1jet with shower arm
48491, -000, -670, -xxx



/ Connection thread G 1/2



Overhead shower 75 1jet EcoSmart with shower arm
48490, -000, -670, -xxx



/ Connection thread G 1/2



Overhead showers



Overhead shower 280 2jet with ceiling connection
48494, -000, -670, -xxx

Basic set
26434180



Overhead shower 280 1jet with ceiling connection
48493, -000, -670, -xxx



/ Connection thread G 1/2



Ceiling connector 300 mm for overhead shower 280 2jet
48496, -000, -670, -xxx



Ceiling connector 300 mm for overhead shower 280 1jet
48495, -000, -670, -xxx



AXOR Conscious Showers. Water is precious.

Delightful showers are some of the most precious moments in our daily routines. To make a ritual like this as pleasant as it is responsible, AXOR has developed Conscious Showers. All shower products in this range are characterized by low water consumption, starting from 6 l/min.

AXOR Conscious Showers meet the specific requirements for sustainable use of the precious element of water, while satisfying even the highest aesthetic demands. Whether in round or square design, they can be combined with AXOR bathroom collections in a variety of styles.

158



Overhead shower 245/185 1jet 12 l/min
35373, -000, -670, -xxx

Ecosmart 9 l/min
35374, -000, -670, -xxx

Ecosmart+ 6 l/min
35387, -000, -670, -xxx



Overhead shower 220 1jet 12 l/min
35382, -000, -670, -xxx

Ecosmart 9 l/min
35383, -000, -670, -xxx

Ecosmart+ 6 l/min
35388, -000, -670, -xxx



Overhead shower 245 1jet 12 l/min
35380, -000, -670, -xxx

Ecosmart 9 l/min
35381, -000, -670, -xxx

Ecosmart+ 6 l/min
35389, -000, -670, -xxx



Can be combined with:
Ceiling connector 300 mm round (# 26433XXX)
square (# 26438XXX)
softsquare (# 26966XXX)
Ceiling connector 100 mm round (# 26432XXX)
square (# 26437XXX)
softsquare (# 26965XXX)
Shower arm 390 mm round (# 26431XXX)
square (# 26436XXX)
softsquare (# 26967XXX)

Overhead showers



Plate overhead shower 240 1jet
28494, -000, -xxx



Overhead shower 180 1jet
28489, -000, -xxx



Overhead shower 240 1jet Classic
28474, -000, -xxx

Overhead shower 180 1jet Classic
(not shown)
28487, -000, -xxx



Ceiling connector 300 mm
26433, -000, -670, -xxx

Ceiling connector 100 mm
(not shown)
26432, -000, -670, -xxx

Can be combined with:

Ceiling connector 300 mm round (# 26433XXX), square (# 26438XXX), softsquare (# 26966XXX), Ceiling connector 100 mm round (# 26432XXX), square (# 26437XXX), softsquare (# 26965XXX), Shower arm 390 mm round (# 26431XXX), square (# 26436XXX), softsquare (# 26967XXX)

/ Design matches the AXOR Montreux collection
Combinable with:
/ Shower arm 389 mm (# 27348, -000, -xxx)
/ Ceiling connection 100 mm (# 26432, -000, -xxx)
/ Ceiling connection 300 mm (# 26433, -000, -xxx)



Ceiling connector 300 mm square
26438, -000, -670, -xxx

Ceiling connector 100 mm square
(not shown)
26437, -000, -670, -xxx



Ceiling connector 300 mm softsquare
26966, -000, -670, -xxx

Ceiling connector 100 mm softsquare
(not shown)
26965, -000, -670, -xxx



Shower arm 390 mm
26431, -000, -670, -xxx



Shower arm 390 mm square
26436, -000, -670, -xxx



Shower arm 390 mm softsquare
26967, -000, -670, -xxx



Shower arm 389 mm
27348, -000, -xxx

/ Design matches the AXOR Montreux collection



Wall plate 120/120 softsquare
36725, -000, -xxx

Combinable with:
/ Shower arm 389 mm (# 27348, -000, -xxx)



Wall plate square
27419, -000, -xxx

Combinable with:
/ Shower arm 390 mm (# 26431, -000, -xxx)



Escutcheon softsquare
35214, -000, -670, -xxx

Goes well with:

300 2jet overhead shower (# 35303XXX), 300 1jet overhead shower (# 35300XXX), 250 2jet overhead shower (# 35296XXX), 250 1jet overhead shower (# 35284XXX), 300/300 2jet overhead shower (# 35318XXX), 300/300 1jet overhead shower (# 35314XXX), 250/250 2jet overhead shower (# 35310XXX), 250/250 1jet overhead shower (# 35306XXX)

Side showers/hand showers



Shower module 120/120
for concealed installation square
28491, -000, -xxx
for concealed installation softsquare
(not shown)
36822, -000, -xxx
Basic set
28486180



Body shower round 1jet
28464, -000, -xxx
Body shower square 1jet (not shown)
28469, -000, -xxx



Hand shower 75 1jet EcoSmart
48651, -000, -670, -xxx



/ Metal hand shower for
a long-lasting quality



Hand shower 2jet
45720, -000, -670, -xxx



/ Change of spray modes
by easily using the
Select technology



Baton hand shower 2jet
12680, -000, -xxx



/ Hand shower in organic design
available, matching the AXOR
Starck Organic collection



Baton hand shower 2jet
28532, -000, -670, -xxx



Baton hand shower 1jet (not shown)
10531, -000, -xxx



Hand shower 85 1jet
26025, -000, -xxx



/ Overhead shower available
in matching design
(# 26022, -000, -xxx or
26021, -000, -xxx)



Hand shower 120 3jet
26050, -000, -670, -xxx



Hand shower 100 1jet
16320, -000, -xxx



/ Overhead shower available
in matching design
(# 28487, -000, -xxx or
28474, -000, -xxx)

Shower sets



Shower set 75 1jet EcoSmart
with wall connection
48791, -000, -670, -xxx



/ Including hand shower 1jet
(# 48651, -000, -670, -xxx)



Wall bar with wall connection
48792, -000, -670, -xxx

/ Combinable with hand shower
1jet (# 48651, -000, -670, -xxx)
or other AXOR hand showers



Shower set 0.90 m
with hand shower 2jet
45722, -000, -670, -xxx



/ Horizontally positioned hand
shower enhances the revitalizing
effect of the flood spray



Shower set 0.90 m
with hand shower 85 1jet
26023, -000, -xxx



Shower set 0.90 m
with baton hand shower 2jet
12231, -000, -xxx



/ Matching the design of the AXOR
Starck Organic collection



Shower set 0.90 m
with baton hand shower 2jet
27980, -000, -xxx



with baton hand shower 1jet
(not shown)
27983, -000, -xxx



Shower bar 0.90 m (not shown)
27830, -000, -xxx



Shower set 0.90 m
with hand shower 120 3jet
27987, -000, -xxx

Shower bar 0.90 m (not shown)
27989, -000, -xxx



Shower set 0.90 m
with hand shower 120 3jet
36735, -000, -xxx

Shower bar 0.90 m (not shown)
36736, -000, -xxx



/ High-quality double rail
/ Shower slider can be
sweveled from right to left
and from front to back



Shower set 0.90 m
with hand shower 120 3jet
27991, -000, -xxx

Shower bar 0.90 m (not shown)
27831, -000, -xxx



Shower set 0.90 m
with hand shower 100 1jet
27982, -000, -xxx



Shower holder



Shower holder
27515, -000, -xxx



Shower holder
45721, -000, -670, -xxx



Shower holder round
39525, -000, -xxx



Shower holder
16325, -000, -xxx

/ For shower hoses with cylindrical nuts

/ For shower hoses with conical nuts

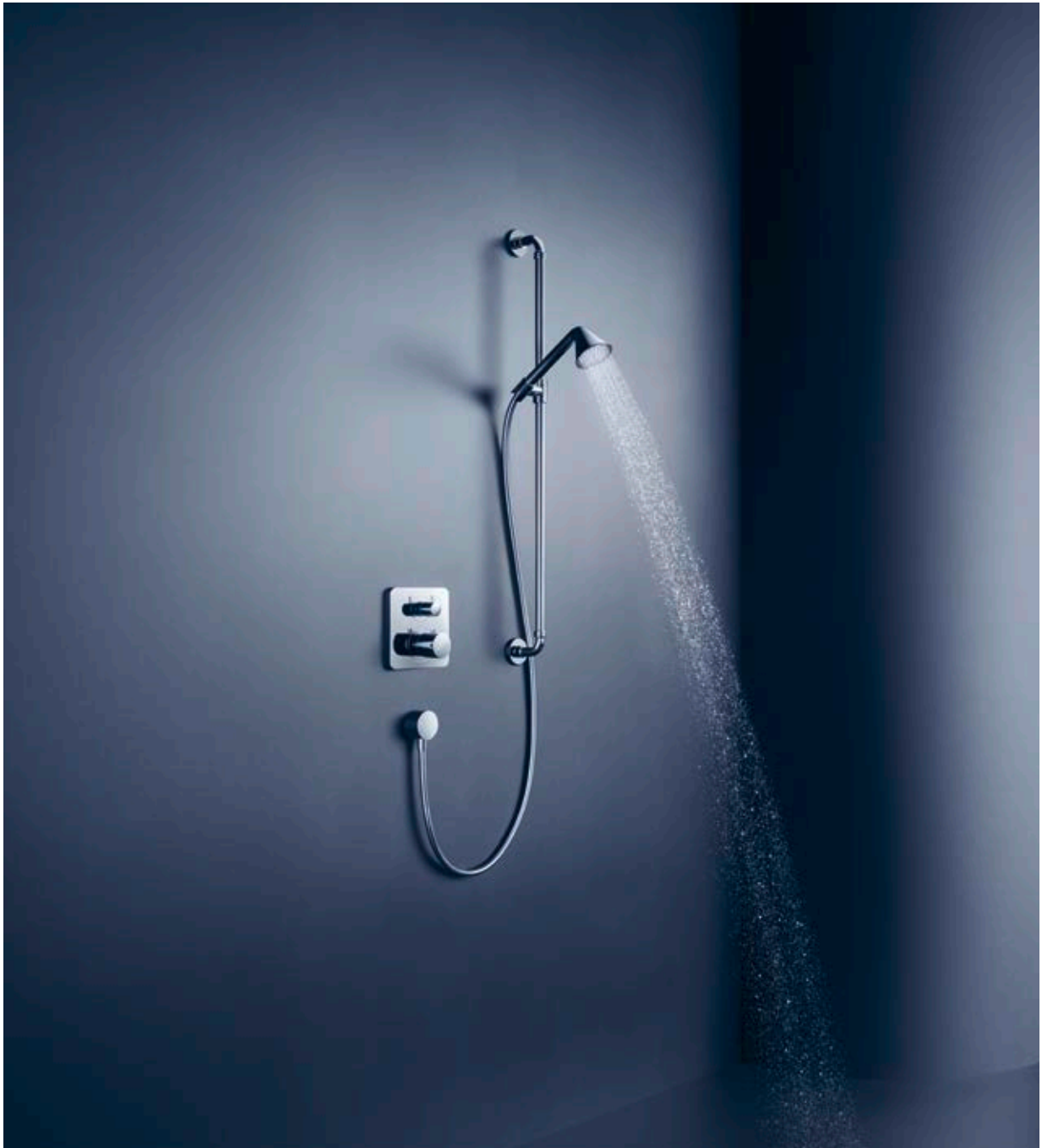

Wall connections / Porter units / Shower hoses



Wall outlet softsquare
36731, -000, -670, -xxx

Wall outlet square (not shown)
36732, -000, -xxx



Wall outlet round
27451, -000, -xxx



Wall outlet with non-return valve
16884, -000, -xxx



Porter unit round
36733, -000, -670

Porter unit square (not shown)
36734, -000, -670

/ For shower hoses with conical nuts on both sides



Porter unit 120/120 softsquare
36724, -000, -670, -xxx

/ For shower hoses with conical nuts on both sides



Porter unit
45723, -000, -670, -xxx

/ For shower hoses with cylindrical nuts on both sides



Porter unit 120/120 with baton hand shower 2jet and shower hose
12232, -000, -xxx



/ Matching the design of the AXOR Starck Organic collection



Porter unit 120/120 with baton hand shower 2jet and shower hose
12626, -000, -xxx



163



Metal shower hose 1.25 m
28112, -000, -670, -xxx

Metal shower hose 1.60 m (not shown)
28116, -000, -xxx

Metal shower hose 2.00 m (not shown)
28120, -000, -xxx

/ Conical nuts on both sides



Shower hose 1.25 m
28622, -000, -670, -xxx

Shower hose 1.60 m (not shown)
28626, -000, -670, -xxx

Shower hose 2.00 m (not shown)
28624, -000, -670, -xxx



Shower hose 1.25 m with volume control
28127, -000, -xxx

Shower hose 1.60 m with volume control (not shown)
28128, -000, -xxx

/ Cylindrical nuts on both sides



Metal effect shower hose 1.25 m
28282, -000, -670, -xxx

Metal effect shower hose 1.60 m (not shown)
28286, -000, -670, -xxx

Metal effect shower hose 2.00 m (not shown)
28284, -000, -xxx

Design object with industrial character

The AXOR shower pipes and shower systems are complete shower solutions consisting of faucet or thermostat, overhead and hand shower for the shower. With the AXOR shower pipe designed by Front, with funnel-shaped overhead and hand shower, nothing will stay hidden. Pipes, sockets, valves – all the elements of typical industrial design are deliberately visible, not hidden behind the wall. A shower pipe with industrial character.



Showerpipe with thermostat and overhead shower 240 2jet # 26020, -000, -xxx





Showerpipe 280 1jet
for concealed installation
48790, -000, -670, -xxx

Basic set
48798180



Showerpipe with thermostat 800
and overhead shower 350 1jet
27984, -000, -xxx



/ Matching the purist design of
the AXOR Uno collection
/ Thermostat 800 also available
as individual product
(# 45440, -000, -820, -xxx)

NEW



Shower column with hand shower
12672, -000, -670, -xxx

Basic set
10902180



/ Matching the minimalist design
of the AXOR Starck collection



AXOR Starck Nature Shower. Luxurious shower experience for the outdoors.

The AXOR Starck Nature Shower offers all the comfort, convenience, and luxury of the AXOR Starck collection in two versions suitable for outdoor use, one with a hand shower. Equipped with PowderRain technology, the AXOR Starck Nature Shower overhead shower envelops the user in a spray of ultra-fine water droplets. The cylindrical handles allow precise control of water temperature and flow rate. The AXOR Starck Nature Shower can be installed on a variety of individually selected materials, from glass to stone and metal to wood. An effective drainage system prevents the water from freezing in the column at colder temperatures.



Nature shower column
with hand shower
12670, -670, -xxx

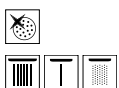

Nature shower column
12671, -670, -xxx



Optional parts:

- / Extension for 80 mm adapter set # 13608000
- Water supply cover # 12675000

- / The Matt Black surface and the AXOR FinishPlus PVD surface finishes are weather-resistant and suitable for outdoor use.





Showerpipe with thermostat
and overhead shower 240 ljet
16572, -000, -xxx



/ Matching the authentic-
traditional design of the
AXOR Montreux collection



Showerpipe with single lever mixer
and overhead shower 180 ljet
39620, -000, -xxx



/ Matching the monumental design of the AXOR Citterio collection



Showerpipe with thermostat
and overhead shower 180 ljet
39670, -000, -xxx



Intuitive control in the shower

Uncompromising in its **purist** form, the thermostatic mixer 800 for exposed/concealed installation unites the advantages of both types of installation. Exposed in that the thermostatic mixer provides a large mirror glass shelf. Concealed because the pipework is behind the wall. Thanks to Select technology, which makes the thermostatic mixer control intuitive.

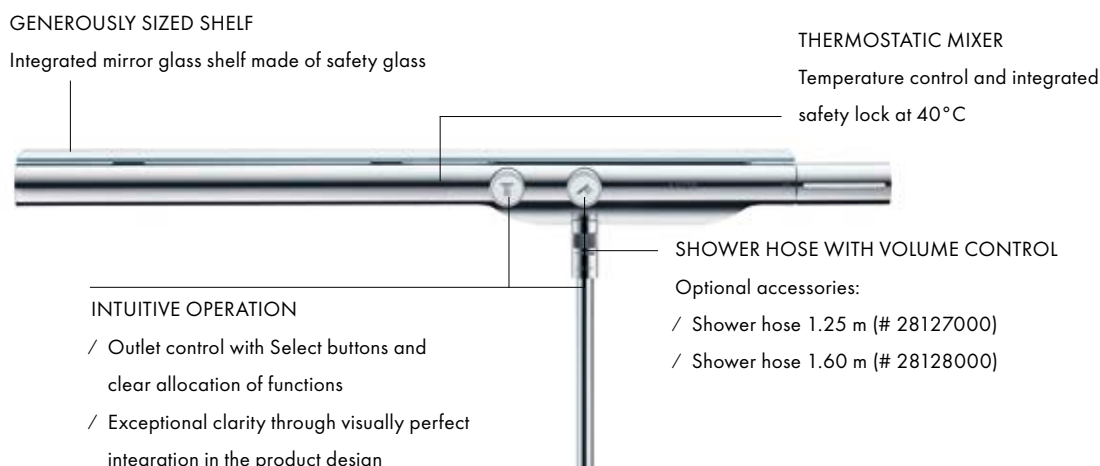

170

The thermostatic module Select integrates all of the functions – outlet selection, volume control and temperature setting – in one control unit. The clearly designed icons are easy to recognize and the large buttons are easy to operate, even with soapy fingers or limited mobility.

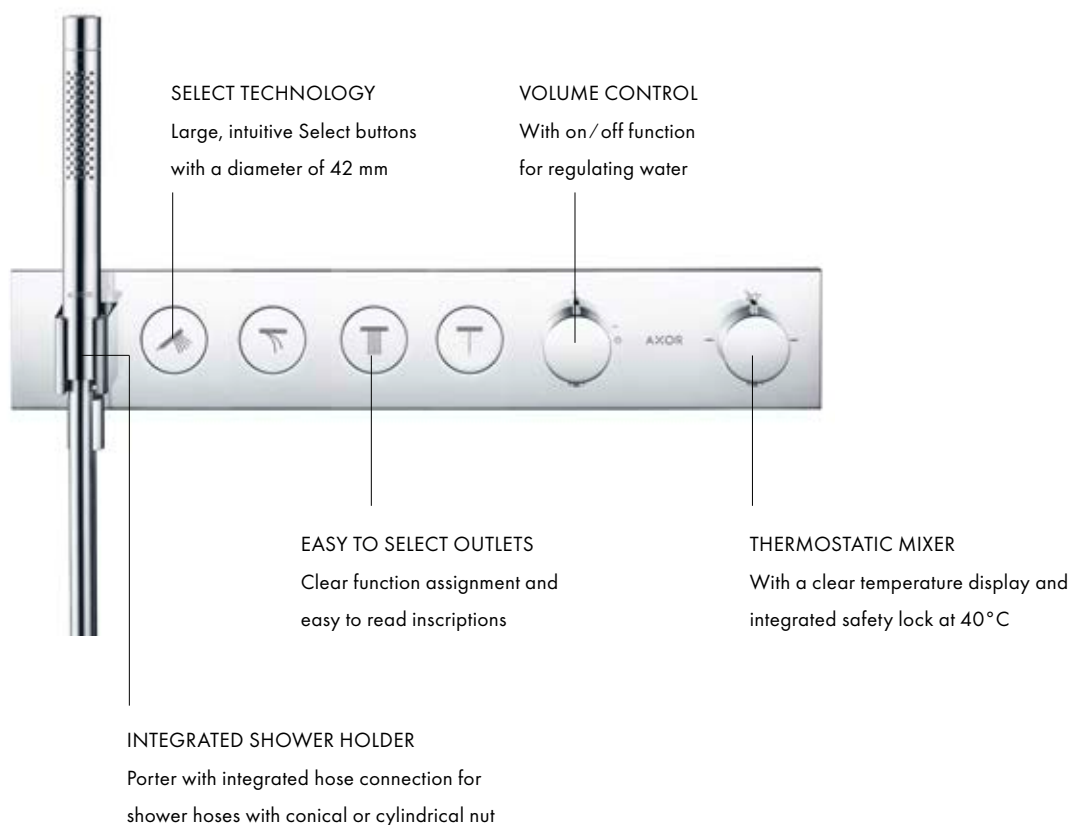

Thermostats



Bath thermostat 1200
for exposed installation
45421, -000, -xxx



Bath thermostat 800
for exposed installation
45420, -000, -xxx



Thermostat 800
for exposed / concealed installation
45440, -000, -xxx

Basic set
45442180



/ Purist design matching the AXOR Uno collection

Optional parts:

- / Shower hose 1.25 m with volume control (# 28127, -000, -820, -xxx)
- / Shower hose 1.60 m with volume control (# 28128, -000, -820, -xxx)



Thermostatic module Select 670/90
for concealed installation
for 5 functions
18358, -000, -xxx

Basic set
18313180



Thermostatic module Select 600/90
for concealed installation
for 4 functions
18357, -000, -xxx

Basic set
18312180



Thermostatic module Select 530/90
for concealed installation
for 3 functions
18356, -000, -xxx

Basic set
18311180



Thermostatic module Select 460/90
for concealed installation
for 2 functions
18355, -000, -xxx

Basic set
18310180



Thermostats



Thermostatic module 360/120 for concealed installation square for 3 functions
10751, -000, -xxx

Basic set
10750180

/ Vertical and horizontal positioning possible



Thermostatic module 120/120 for concealed installation square
10755, -000, -xxx

Basic set
10754180



Shut-off valve 120/120 for concealed installation square
10972, -000, -xxx

Basic set
10971180

Basic set 52 l/min for spindle
16973180

Basic set 40 l/min for ceramic
16974180

Basic set 130 l/min for spindle
16970180



Shut-off/diverter valve Trio/Quattro 120/120 for concealed installation
10932, -000, -xxx

Basic set for Trio 120/120
36770180

Basic set for Trio
16982180

Basic set for Quattro
16930180



Hand shower module 120/120 for concealed installation square
10651, -000, -xxx

Basic set
10650180



Shelf 120/120
40872, -000, -xxx



Shelf 240/120
40873, -000, -xxx



Thermostat HighFlow for concealed installation softsquare
36711, -000, -670, -xxx

Basic set iBox universal
01700180



172



Thermostat HighFlow for concealed installation softsquare for 1 function and additional outlet
36706, -000, -xxx

Basic set iBox universal
01700180



Valve for concealed installation softsquare for 3 functions
36773, -000, -670, -xxx

Basic set iBox universal
01700180



Thermostat for concealed installation softsquare for 1 function
36705, -000, -xxx

Basic set iBox universal
01700180



Thermostat for concealed installation softsquare for 2 functions
36707, -000, -670, -xxx

Basic set iBox universal
01700180



Thermostats



Thermostat HighFlow
for concealed installation round
36721, -000, -xxx

Basic set iBox universal
01700180



Thermostat HighFlow
for concealed installation round
for 1 function and additional outlet
36726, -000, -xxx

Basic set iBox universal
01700180



Valve for concealed installation round
for 3 functions
36727, -000, -xxx

Basic set iBox universal
01700180



Thermostat for concealed installation
round for 1 function
36722, -000, -xxx

Basic set iBox universal
01700180



Thermostat for concealed installation
round for 2 functions
36723, -000, -670, -xxx

Basic set iBox universal
01700180



Thermostat HighFlow for concealed
installation square
36718, -000, -xxx

Basic set iBox universal
01700180



Thermostat HighFlow
for concealed installation square
for 1 function and additional outlet
36716, -000, -xxx

Basic set iBox universal
01700180



Valve for concealed installation
square for 3 functions
36717, -000, -xxx

Basic set iBox universal
01700180



Thermostat for concealed installation
square for 1 function
36714, -000, -xxx

Basic set iBox universal
01700180



Thermostat for concealed installation
square for 2 functions
36715, -000, -670, -xxx

Basic set iBox universal
01700180



Thermostat for concealed installation
square for 2 functions
with wall outlet and shower holder
36712, -000, -xxx

Basic set iBox universal
01700180





TEMPERATURE REGULATION

- / Precisely controllable with the large, cylindrical knob
- / Safety lock limits temperature to 40°C
- / Maximum temperature adjustable



OUTLET CONTROL

- / Large Select paddles turn the water on and off easily
- / Complete control with finger, hand or even elbow operation
- / Up to three functions can be activated - separately or at the same time
- / A porter can be added

VOLUME CONTROL

- / For economical water consumption
- / Volume control reduces water flow continuously by up to 50% - depending on flow volume and installation situation

OPERATION

- / Large symbols on the paddles indicate clearly which outlet is being used
- / The paddle icons can be applied easily after installation



Thermostatic module for concealed installation for 3 functions
45713, -000, -670, -xxx

Basic set
45710180



Thermostatic module for concealed installation for 2 functions
45712, -000, -670, -xxx

Basic set
45710180



Thermostatic module for concealed installation for 1 function
45711, -000, -670, -xxx

Basic set
45710180



Shut-off valve for concealed installation
45771, -000, -670, -xxx

Basic set
45770180





AXOR

AXOR Accessories

Highest expression of individual style

Even the smallest details can say something about our personality. For individualists, accessories are no minor matter. They are that certain something. They are a statement with a message. AXOR accessories reflect the aspiration of individual design and holistic excellence that underlies the entire AXOR product range.

Design: Philippe Starck, Antonio Citterio,
Barber Osgerby, PHOENIX

—————
EACH INDIVIDUAL AXOR
ACCESSORY IS, IN ITSELF,
A ONE-OF-A-KIND
DESIGN OBJECT.
—————

CHARACTERISTIC DESIGN FEATURE:

From minimalist to sculptural, from organic to classic, from extravagant to universal.

THE DESIGNERS' IDEA:

Perfect **accessories**: AXOR Accessories are coordinated with the various collections so that they complement and complete the bathroom atmosphere. Or bring the extra flair of a design object to the bathroom or kitchen. In contrast, AXOR Universal Accessories are linear and modular in design, so they fit to many different collections.

SPECIAL PROGRAM HIGHLIGHTS:

- / AXOR Universal Rectangular Accessories: ideal complement to AXOR collections with cubic or rectangular design language
- / AXOR Universal Circular accessories: Timeless, round design, versatile combinations
- / AXOR Universal Softsquare Accessories: Modular, versatile range in linear design
- / AXOR Montreux: Authentic-traditional design, for combination with classic faucets and shower products

AXOR



AXOR Universal Rectangular Accessories

The new AXOR Universal Rectangular Accessories, developed in collaboration with Philippe Starck, are the ideal complement to any AXOR collection with a cubic or rectangular design language. Their clear, no-frills design never takes center stage, but sets understated, high-quality accents in the bathroom. The broad product range includes a shaving mirror, a soap dispenser, toilet paper holders, and a variety of towel bars.

Design: Philippe Starck

SHAVING MIRROR

- / Consistently rectangular design
- / Swiveling



SINGLE HOOK

- / Flat, precise design

BATH TOWEL BAR

- / Wall mounting perfectly reflects the collection's design

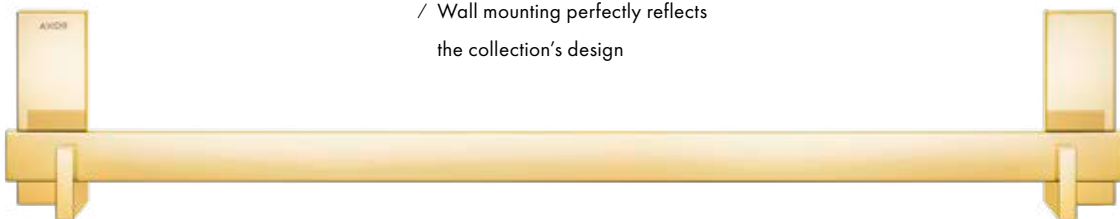

AXOR Universal Rectangular Accessories

NEW



Toothbrush tumbler
42604, -000, -xxx

NEW



Soap dish
42605, -000, -xxx

NEW



Liquid soap dispenser
42610, -000, -xxx

NEW



Shelf 300
42644, -000, -xxx

NEW



Grab bar
42613, -000, -xxx

NEW



Bath towel rail 600 mm
42661, -000, -xxx

NEW



Bath towel rail 800 mm
42683, -000, -xxx

180

NEW



Towel holder
42626, -000, -xxx

NEW



Towel holder twin-handle
42622, -000, -xxx

NEW



Towel ring
42623, -000, -xxx

NEW



Towel hook
42611, -000, -xxx

NEW



Shaving mirror
42649, -000, -xxx

NEW



Shower door handle
42639, -000, -xxx

AXOR Universal Rectangular Accessories

NEW



Toilet paper holder
42656, -000, -xxx

NEW



Toilet paper holder double
42657, -000, -xxx

NEW



Spare roll holder
42654, -000, -xxx

NEW



Toilet brush holder wall-mounted
42655, -000, -xxx





AXOR Universal Circular Accessories

With their *minimalist*, delicate, and timeless design combined with the utmost precision, AXOR Universal Circular accessories offer simplicity in form – for a harmonious overall impression in the bathroom. The products are characterized by a consistent, recognizable design language that runs through all areas of the bathroom – with slim silhouettes, rounded corners, and balanced proportions. Thanks to their timeless design, the products can be combined completely freely with different styles and fit perfectly with the AXOR portfolio collections. AXOR FinishPlus allows for customization with different PVD surfaces, as well as the new lacquered Matt Black surface.

Design: Barber Osgerby



DOUBLE HOOK
/ Minimalistic design
/ Slim silhouettes

WALL MIRROR
/ Diameter: 600 mm
/ New Matt Black painted surface



LOTION DISPENSER
/ Filling capacity: 300 ml
/ Dosage: 2 ml
/ Corrosion-resistant spout tube

AXOR Universal Circular Accessoires



Toothbrush tumbler
42804, -000, -670, -xxx



Soap dish
42805, -000, -670, -xxx



Liquid soap dispenser
42810, -000, -670, -xxx



Grab bar
42813, -000, -670, -xxx



Bath towel rail 600 mm
42860, -000, -670, -xxx



Bath towel rail 800 mm
42880, -000, -670, -xxx



Towel holder
42826, -000, -670, -xxx



Towel holder twin-handle
42822, -000, -670, -xxx

184



Towel ring
42823, -000, -670, -xxx



Towel hook
42811, -000, -670, -xxx



Towel hook double
42812, -000, -670, -xxx



Towel rack with towel holder
42843, -000, -670, -xxx



Shelf
42844, -000, -670, -xxx



Toilet paper holder with cover
42858, -000, -670, -xxx



Toilet paper holder
42856, -000, -670, -xxx



Toilet paper holder double
42857, -000, -670, -xxx

AXOR Universal Circular Accessoires



Toilet brush holder wall-mounted
42855, -000, -670, -xxx



Tissue box
42873, -000, -670, -xxx



Waste bin
42872, -000, -670, -xxx



Shaving mirror
42849, -000, -670, -xxx



Wall mirror
42848, -000, -670



The wide product range of the AXOR Universal Circular Accessories program includes a bath towel bar – also available in the new painted Matt Black finish.

AXOR Universal Softsquare Accessories

A new take on the special in everyday life: The AXOR Universal Softsquare accessories – including shelves, bath towel bars, soap dispensers, and even coat hooks – are **timelessly** elegant extras that can be used individually or flexibly combined with each other. With their straightforward, generic **design**, they complete the overall **aesthetic** impression of an individual bathroom or kitchen design. Their elegantly rounded corners and universal design harmonize with several AXOR collections and very different style worlds.

Design: Antonio Citterio



Products required:

- a. Rail
- b. # 42838000 + 2 x # 42870000 Adapterset
- c. # 42834000 + 1 x # 42870000 Adapterset



1

Removable glass cover for easy filling and cleaning

Highly hygienic because the scratch-resistant, white glass can be cleaned in the dishwasher

Generously sized shelf surface

Their timeless design allows AXOR Universal Softsquare Accessoires to match every bathroom style seamlessly

Liquid soap dispenser # 42819000



188

2



Asymmetrical positioning of shelf (300 mm) on the rail. Adapter set required.

Products required:

- a. # 42838000 AXOR Universal Softsquare shelf 300 mm
- + 1 x # 42870000 Adapterset
- b. Rail

3



An elegant combination of a rail with shelf (300 mm, installed *asymmetrically*) and toilet paper holder. Two adapter sets required.

Products required:

- a. # 42838000 AXOR Universal Softsquare shelf 300 mm
- + 1 x # 42870000 Adapterset
- b. # 42836000 AXOR Universal Softsquare toilet paper holder
- + 1 x # 42870000 Adapterset
- c. Rail

4



Large shelf surface: shelf (300 mm) and liquid soap dispenser on a rail. Three adapter sets required.

Products required:

- a. # 42838000 AXOR Universal Softsquare shelf 300 mm
- + 2 x # 42870000 Adapterset
- b. # 42819000 AXOR Universal Softsquare lotion dispenser
- + 1 x # 42870000 Adapterset
- c. Rail

5

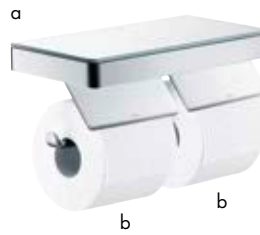

Triple duty: Shelf (300 mm) with two toilet paper holders. Two adapter sets required. One toilet paper holder is mounted in mirrored position.

Products required:

- a. # 42838000 AXOR Universal Softsquare shelf 300 mm
- + 2 x # 42870000 Adapterset
- b. 2 x # 42836000

189

6

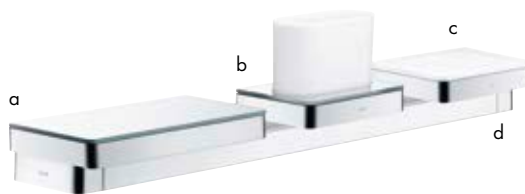

Everything is right where you need it: Multi-functional combination of a rail with shelf (300 mm), toothbrush holder and soap dish/shelf (150 mm). Four adapter sets required.

Products required:

- a. # 42838000 AXOR Universal Softsquare shelf 300 mm
- + 2 x # 42870000 Adapterset
- b. # 42836000 AXOR Universal Softsquare toilet paper holder
- + 1 x # 42870000 Adapterset
- c. # 42803000 + 1 x # 42870000 Adapterset
- d. Rail

7



Toilet paper holder with soap dish/shelf (150 mm) – a space-saving combination for the guest bathroom. One adapter set required.

Products required:

- a. # 42803000 AXOR Universal Softsquare soap dish
- + 1 x # 42870000 Adapterset
- b. # 42836000 AXOR Universal Softsquare toilet paper holder

AXOR Universal Softsquare Accessories



Toothbrush tumbler
42834, -000, -670, -xxx



Soap dish/shelf
42803, -000, -670, -xxx



Liquid soap dispenser with shelf
42819, -000, -670, -xxx



Shelf 300
42838, -000, -xxx

/ Adapter set # 42870, -000, -xxx must be used for installation on a rail
/ Optional: Rail grab bar 300 mm (# 42830, -000, -xxx)

/ Two adapter sets
42870, -000, -xxx must be used for installation on a rail (for asymmetric installation only one adapter set)
/ Optional: Rail grab bar 300 mm (# 42830, -000, -xxx)



Shelf 150
42840, -000, -670, -xxx



Shelf 150/70 for shower
42802, -000, -xxx



Rail grab bar 300 mm
42830, -000, -670, -xxx



Rail bath towel holder 600 mm
42832, -000, -670, -xxx

/ Adapter set # 42870, -000, -xxx must be used for installation on a rail
/ Optional: Rail grab bar 300 mm (# 42830, -000, -xxx)

Optional parts:
Cover for rail (# 42871, -000, -xxx)

190



Rail bath towel holder 800 mm
42833, -000, -670, -xxx



Shower door handle 444 mm
42837, -000, -670, -xxx



Bath towel shelf
42842, -000, -xxx



Towel holder twin-handle
42821, -000, -670, -xxx

Optional parts:
Cover for rail
(# 42871, -000, -xxx)



Single hook
42801, -000, -670, -xxx



Roll holder
42436, -000, -xxx



Roll holder with cover
42836, -000, -670, -xxx



Toilet roll holder without cover
42846, -000, -670, -xxx

/ Combinable with soap dish # 42803, -000, -xxx and shelf 300 mm # 42838, -000, -xxx (adapter set # 42870, -000, -xxx necessary)
/ Optional: Soap dish/shelf (# 42803, -000, -xxx)

AXOR Universal Softsquare Accessories



Toilet brush holder wall-mounted
42835, -000, -670, -xxx



Adapter set
42870, -000, -670, -xxx



Cover for rail
42871, -000, -670, -xxx



Cover 150 mm
42890, -000, -xxx

Cover 300 mm (not shown)
42891, -000, -xxx

Required parts:
/ Rail bath towel holder
in different lengths
/ Shower set 0.90 m with
hand shower 120 3jet
(# 36735, -000, -xxx)

/ Covers the back side of the
shelf when installed on a glass
wall or glass shower enclosure

AXOR ShowerCollection Accessories



Shelf 120/120
40872, -000, -xxx



Shelf 240/120
40873, -000, -xxx

Basic set
40877180

Basic set
40878180

/ Basic set needed for joined installation with the AXOR ShowerCollection
modules
/ For use with either vertical or horizontal installation of the basic set



AXOR Montreux Accessories



Toothbrush tumbler
42134, -000, -xxx



Liquid soap dispenser
42019, -000, -xxx

/ Filling capacity 300 ml



Soap dish
42033, -000, -820, -xxx



Corner basket 160/101
42065, -000, -xxx

Corner basket 160/83 (not shown)
42066, -000, -xxx

/ Corner basket (# 42066, -000, -820, -xxx) suitable for installation on a Unica wall bar Ø 22 mm



Grab bar
42030, -000, -xxx



Bath towel rail 600 mm
42060, -000, -xxx

Bath towel rail 800 mm (not shown)
42080, -000, -xxx

Towel holder
42020, -000, -xxx



Towel ring
42021, -000, -xxx



Single hook
42137, -000, -xxx



Roll holder with cover
42036, -000, -xxx



Roll holder without cover
42028, -000, -xxx



Toilet brush holder wall-mounted
42035, -000, -xxx



Shaving mirror
42090, -000, -xxx



Design: PHOENIX



AXOR Electronic Mixers

Non-contact Design mixers

Electronic mixers by AXOR set standards for comfort, hygiene and **design**. The non-contact operation makes them perfect for use in public areas such as hotels, restaurants or lounges. But they also make a masterful statement in private bathrooms and meet the highest requirements for efficient water consumption. Combined with outstanding design and functionality.

Design: Philippe Starck, Antonio Citterio, PHOENIX

AXOR ELECTRONIC
MIXERS ARE THE
PERFECT COMBINATION
OF TECHNOLOGY
AND DESIGN.

CHARACTERISTIC DESIGN FEATURE:

Reduced to the bare essentials: The mixers do not need handles because sensor technology controls the water.

THE DESIGNERS' IDEA:

Masterpieces of comfort, hygiene and design: AXOR Electronic mixers combine sensor control with outstanding design – simply excellent. Masterpieces of non-contact operation.

SPECIAL PROGRAM HIGHLIGHTS:

- / AXOR Electronic is available in the design of these collections: AXOR Starck, AXOR Starck Organic, AXOR Citterio and AXOR Uno
- / Sensor control: non-contact means extremely hygienic
- / Efficient water use: Sensor controlled mixers switch off automatically
- / Available in two versions: With temperature preset or temperature control
- / Operates with 230 V power connection or battery

Functionality and technology. Exclusive design

AXOR Electronic mixers combine functionality and technology with exclusive **design** known for its proven brand quality. The innovative sensor technology is **discreetly** integrated so that mixer design can be reduced to the basics. Non-contact mixers are not only hygienic, but also save water: The intelligent electronics release water only when it is actually needed, which protects this natural resource.



AXOR UNO

Minimalist in design, this electronic, wall-mounted mixer has a sensor field on the bottom of the spout.



AXOR STARCK ORGANIC

This minimalist, **organic** mixer saves a great deal of water: The ample mixer shower jet uses just 3.5 l/min. The mixer is available with and without temperature control.

AXOR STARCK

Also reduced to the basics is the electronic variant of the **purist** AXOR Starck basin mixer. Available with and without temperature control.

Wash basin



Electronic basin mixer
with temperature control
battery-operated
10101, -000, -xxx

with temperature control
with mains connection 230 V
(not shown)
10140, -000, -xxx



/ Design matches the AXOR Starck Organic collection
/ Due to technical reason the product # 10415xxx is not available in the surface finish Polished Nickel



Electronic basin mixer
with temperature pre-adjustment
battery-operated
10106, -000, -xxx

with temperature pre-adjustment
with mains connection 230 V
(not shown)
10145, -000, -xxx



Electronic basin mixer
with temperature control
battery-operated
12171, -000, -xxx

with temperature control
with mains connection 230 V
(not shown)
12173, -000, -xxx



/ Design matches the AXOR Starck Organic collection



Electronic basin mixer
with temperature pre-adjustment
battery-operated
12172, -000, -xxx

with temperature pre-adjustment
with mains connection 230 V
(not shown)
12174, -000, -xxx



Electronic basin mixer
for concealed installation
wall-mounted with spout 161 mm
39117, -000, -xxx

wall-mounted with spout 221 mm
(not shown)
39118, -000, -xxx

Basic set
16180180



/ Design matches the
AXOR Criterio collection



Electronic basin mixer
for concealed installation
wall-mounted with spout 165 mm
38119, -000, -670, -xxx

wall-mounted with spout 225 mm
(not shown)
38120, -000, -670, -xxx

Basic set
16180180



/ Design matches the AXOR Uno collection
/ Due to technical reason the product # 38010xxx is not available in the surface finishes Polished and Brushed Red Gold and Polished and Brushed Black Chrome



Electronic basin mixer
for concealed installation
wall-mounted with spout 161 mm
45110, -000, -xxx

with spout 221 mm (not shown)
45111, -000, -xxx

Basic set
16180180



Electronic basin mixer
with temperature pre-adjustment
with mains connection 230 V
38010, -000, -670, -xxx

Basic set
16182180



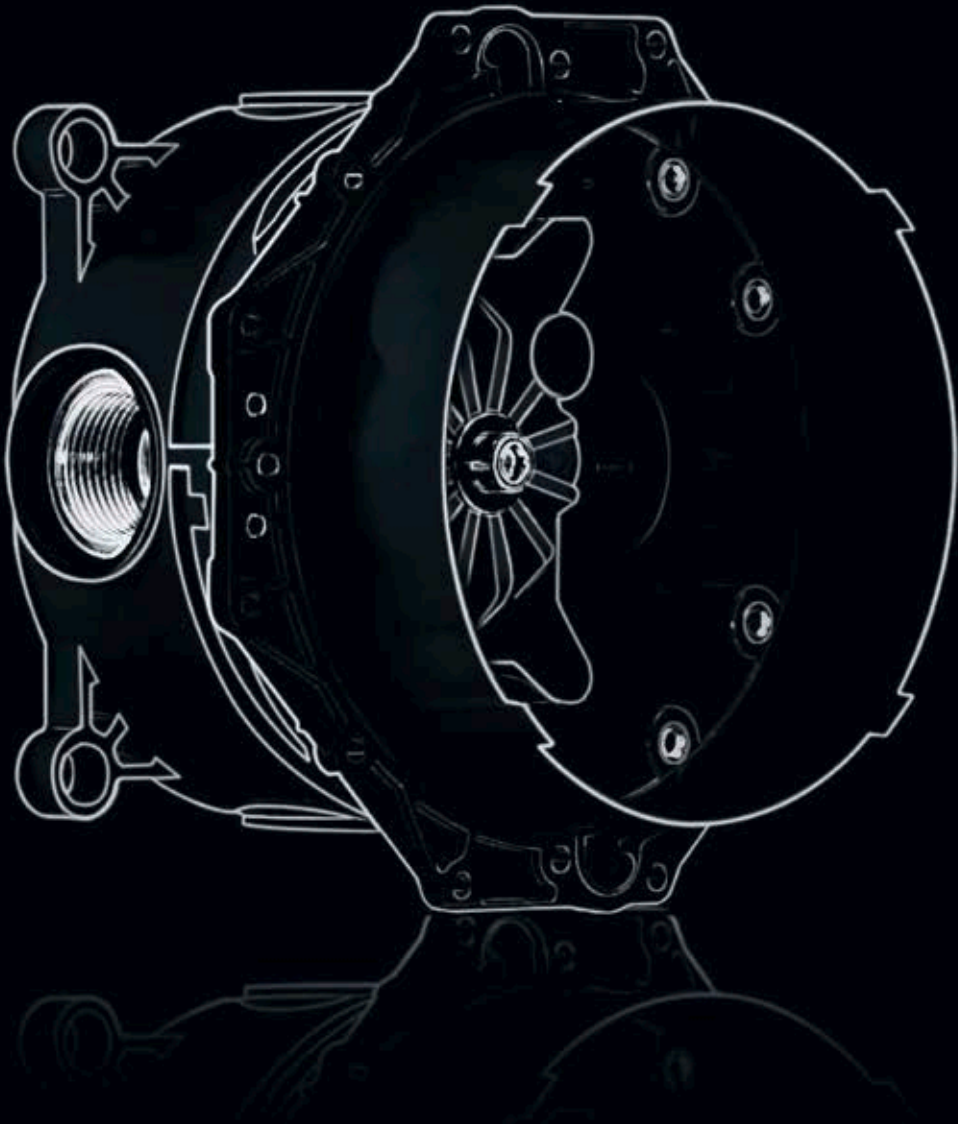

AXOR basic sets, waste sets and overflow sets

Technology with a system

The perfection of AXOR continues into the wall and below the bathtub or wash basin, always making an appearance where mixers and showers are installed. The AXOR basic sets, waste sets and overflow sets are based on the many years of expertise gathered by the Hansgrohe Group. They are produced according to the highest quality standards.

199

SPECIAL PROGRAM HIGHLIGHTS:

iBox universal

- / One basic set for numerous types of concealed installations. Especially easy to install
- / Can be used for more than 15 different complete sets for concealed installations of showers, bathtubs and thermostatic mixers
- / Easy preinstallation increases flexibility in the process for selecting mixers
- / Greater freedom of movement when showering
- / Effortless replacement with new mixers for renovations
- / Simplified project planning because one basic set is used for all installations
- / Can be used in both private and public areas
- / Meets common standards worldwide

Learn more about AXOR basic sets, waste sets and overflow sets:
pro.hansgrohe.com

iBox universal: Utterly convincing

AXOR stands for perfection in every dimension. One example: iBox universal. One basic set for numerous types of concealed installations. Uncompromising, reliable and definitely easy to install.

200

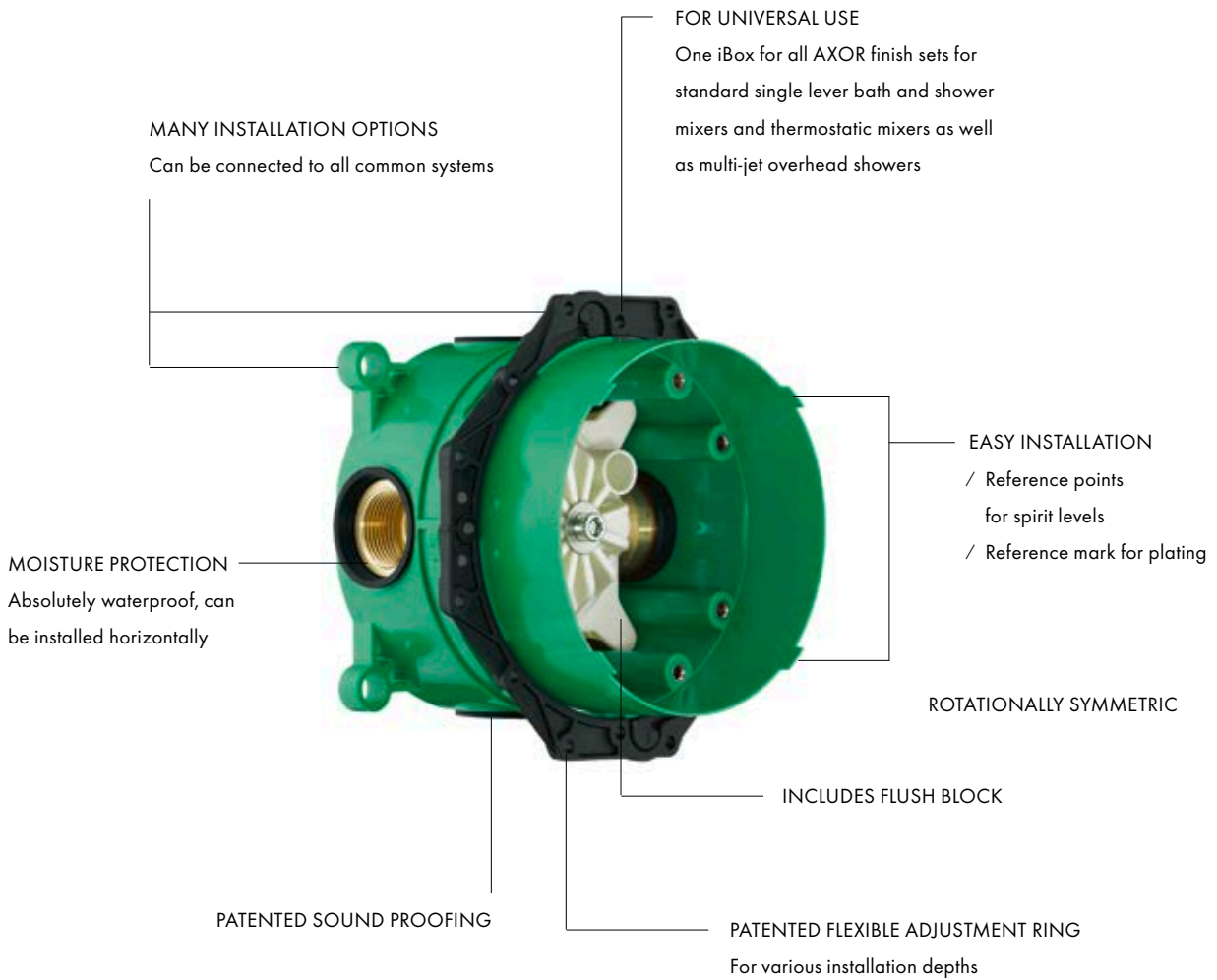

Basic set iBox universal
01700180



Basic set iBox universal
with shut-off unit
01750180



Extension 25 mm
for basic set iBox universal
13587000



Fastening rail set
for iBox universal
93171000



Extension element
98860, -000, -xxx



Extension element softsquare 1-hole
14971, -000, -xxx



Extension element softsquare 2-hole
14972, -000, -xxx



Extension element softsquare 2-hole
0-1-2
14973, -000, -xxx

/ For mounting between
tiles and pre-fab set
/ Suitable for all concealed-
installation pre-fab sets
in Softsquare design



Extension element softsquare 2-hole
arrow
14974, -000, -xxx



Extension element square 1-hole
14964, -000, -xxx



Extension element square 1-hole
red blue
14965, -000, -xxx



Extension element square 1-hole
arrow
14966, -000, -xxx



Extension element square 2-hole
14967, -000, -xxx



Extension element square 2-hole
red blue
14968, -000, -xxx



Extension element square 2-hole
0-1-2
14969, -000, -xxx



Extension element square 2-hole
arrow
14970, -000, -xxx



Extension element round 1-hole
14960, -000, -xxx



Extension element round 2-hole
14961, -000, -xxx



Extension element round 2-hole
0-1-2
14962, -000, -xxx



Extension element round 2-hole
arrow
14963, -000, -xxx

Fillers, waste sets and overflow sets for bathtubs



Complete set bath filler, waste and overflow set for standard bath tubs
58307, -000, -670, -xxx



Complete set bath filler, waste and overflow set for special bath tubs
58317, -000, -670, -xxx



Flexible connection tube 800 mm
58308000



Finish set square
28012, -000, -xxx



Finish set oval
28022, -000, -xxx



Basic set
15490180

Basic set
15490180

Basic set
15490180

- / sBox for quiet, smooth and safe hose guiding
- / Suitable for rim- or tile-mounted installation
- / Bath rim width at least 100 mm
- / Maximum pull-out length of individually selectable hand shower: 1.45 m

202



Installation plate for tile mounted installation
28014000



Mounting angle for installation plate for tile mounted installation
28011000



Rim mounted adapter 25°
28071000

Waste- and overflow set for bath tubs



Complete set waste and overflow set for standard bath tubs
58316, -000, -670, -xxx



Complete set waste and overflow set for special bath tubs
58318, -000, -670, -xxx

Waste sets for wash basins / Bidet



Waste set pop-up for basin and bidet mixers
51302, -000, -xxx



Waste set push-open for basin and bidet mixers
51300, -000, -xxx



Waste set non-closing for washbasins
51301, -000, -xxx

Siphons



Design trap Flowstar
51303, -000, -xxx



Design trap set Flowstar
51304, -000, -xxx



Design trap Flowstar S
51305, -000, -670, -xxx



Cover
51306, -000, -670, -xxx

/ Due to technical reasons this product is not available in the surface finishes Polished and Brushed Black Chrome
Included in scope of delivery:
/ Design trap Flowstar (# 51303, -000, -820, -xxx)
/ Angle valve with cover outlet G^{3/8} (# 51307, -000, -820, -xxx)



Angle valve with cover outlet G^{3/8}
51307, -000, -xxx



Angle valve with microfilter outlet G^{3/8}
51308000



Angle valve E outlet G^{3/8}
51312000

Angle valve E outlet G^{1/2} (not shown)
51309000



Angle valve S outlet G^{3/8}
51310000



AXOR Individualization

Individual expression in the bathroom

With collections in a variety of styles, AXOR responds to the desire for individualization in the bathroom. AXOR FinishPlus and AXOR Signature are two services for maximizing options for customers to express their personalities.

With the brushed or polished versions of colored AXOR FinishPlus surfaces, mixers, showers and accessories become design objects that perfectly complete an interior design and create an exclusive accent. The durable, high-quality surfaces are manufactured in a physical vapor deposition process (PVD).

The AXOR Signature service responds to customer requests for modifications such as inscriptions of the customer's signature, or inscriptions in the local language. The service can also provide extended shower connections to meet certain spatial requirements or to modify the mixer spout with respect to the unusual geometry of a wash basin. Experts with many years of experience and a love of detail address the modification requests, creating solutions in accordance with the most advanced industrial standards.

205

THE TWO SERVICES
HAVE ONE THING IN
COMMON: THEY RESULT
IN PRODUCTS THAT
COMBINE INDIVIDUALITY
AND QUALITY AT THE
HIGHEST LEVEL.

SPECIAL FEATURES OF THE INDIVIDUALIZATION SERVICES:

- / Exclusively developed surfaces in brushed or polished versions, some developed specially for AXOR FinishPlus, bring unique personality to the bathroom or kitchen through the use of color
- / The extremely durable surfaces are created with the physical vapor deposition (PVD) process in the AXOR production facility in Schiltach, Germany
- / The new exclusive Matt Black painted surface offers customers maximum customization
- / AXOR Signature service implements highly individualized customer requests: Lengthening, shortening, inscription
- / All modifications are carried out by AXOR experts at the highest level of craftsmanship and in accordance with industrial standards

Learn more about AXOR FinishPlus and AXOR Signature:
axor-design.com

AXOR FinishPlus

Refinement of a special kind

Luxury is all about fulfilling personal dreams. AXOR FinishPlus surfaces are expressions of *individuality* at the highest level. They set new benchmarks for luster, robustness and durability. Whether as single items or in large quantities, they are manufactured at the highest technical level and stand for quality made in Germany.



206

- / AXOR FinishPlus meets the increasing desire for individualization: The surfaces can be made to match the interior design perfectly.
- / A standardized process guarantees consistent quality
- / The Black Chrome and Red Gold surface finishes, developed by our own experts through intensive research work, underline the role of AXOR as an innovative leader in the area of surfaces
- / A mixer with an AXOR FinishPlus surface, along with its spare parts, is available for purchase in an identical quality and design for 15 years
- / In addition to the prespecified AXOR FinishPlus surfaces, other surfaces can be produced according to personal specifications by request through AXOR Signature

Learn more about AXOR FinishPlus:

axor-design.com

Available in quantities of 1 or more



Brushed Brass
-950



Polished Gold Optic
-990



Brushed Gold Optic
-250



Brushed Bronze
-140



Polished Red Gold
-300



Brushed Red Gold
-310



Brushed Nickel
-820



Stainless Steel Optic
-800



Polished Black Chrome
-330



Brushed Black Chrome
-340

The lacquered Matt Black finish is only available for a selected range of AXOR products.



Matt Black
-670

Available in quantities of 30



Polished Chrome
-020



Brushed Chrome
-260



Polished Nickel
-830



Polished Bronze
-130



Polished Brass
-930



The masterly combination of high-tech and craftsmanship

AXOR FinishPlus surfaces are exceptional, with excellent color brilliance. The polished and brushed surfaces' unmistakable character is the result of intensive development, refined in AXOR's in-house vacuum chambers using the physical vapor deposition (PVD) process. The PVD process gives the surfaces an additional metal layer. The vapor deposition of different process gas mixtures creates different light reflections on the surface. The result: excellent color brilliance and high resistance.

- / The beneficial properties of PVD surfaces include resistance to scratching, cleaning agents and salty sea air
- / The special textures of the brushed versions are created by hand

Learn more about AXOR FinishPlus:
axor-design.com

209

AXOR FINISHPLUS SURFACES
BRING EXCLUSIVITY TO
THE BATHROOM.



The lacquered Matt Black finish offers a bold color that lends the product a silky, soft feel and simple elegance.

AXOR Signature

From the special to the one-of-a-kind

Lengthening, shortening, inscription. **AXOR Signature** is an exclusive service that takes a design object and makes it one-of-a-kind, whether by providing each mixer with the customer's personal touch or by modifying it to fit specific dimensions. The personal and customized result manufactured by AXOR experts in Schiltach. With the utmost in care and precise craftsmanship in accordance with industrial standards.

AXOR SIGNATURE PROVIDES THE FOLLOWING SERVICES:

- / Extensions, e.g., from wall to wash basin or bathtub, or from the ceiling into the room
- / New developments
- / Component mix
- / Laser engraving, printing, and deep engraving to integrate initials, logos, or additional markings in the national language or another size, as well as special marking for functions
- / Feasibility testing in advance of order acceptance with individualized delivery schedule and price

210

Learn more about AXOR Signature:
axor-design.com

Standardversion



EXAMPLE INSCRIPTIONS FOR OVERHEAD AND HAND SHOWERS

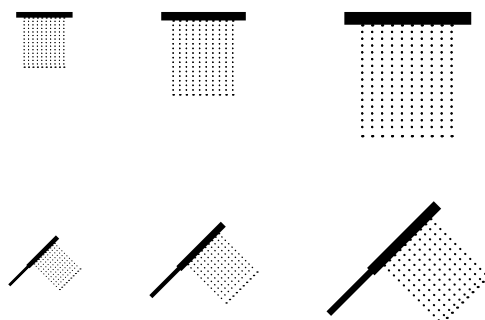



AXOR SIGNATURE FOR AN
INDIVIDUALIZED, PERFECT WHOLE.

CUSTOMIZED VERSION

Application of personalized inscriptions such as
a monogram or icons to clearly identify users



211

EXAMPLE FOR TEMPERATURE LABELS



°C



热 极冷



EXAMPLES FOR BRANDING





Lengthening of a ceiling connection – adapted for the height of the room

212

New development of a faucet handle from the AXOR Montreux collection for the Hotel Villa Copenhagen. In the suites designed by the jewelry company Shamballa Jewels, some of the AXOR faucets are specially equipped with Shamballa gemstone handles.



Length adjustments

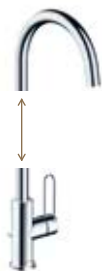

Extending a faucet spout, adapted to the height of the sink

Redevelopment



Development of a product according to customer requirements.

Component mix

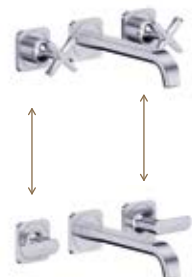

Combination of different design and product components.

A new dimension of individualization

With materials such as metal, glass, wood, marble and leather, **AXOR Signature** creates an entirely new feel for mixers. The cover plates are carefully selected by AXOR experts and designed to meet high benchmarks for mixer use. Each plate is a one-of-a-kind original.

- / Natural materials impart an especially sensual look and feel
- / Each product is **unique**, like the natural material itself

Exclusively for the AXOR MyEdition collection.
See page 44 or axor-design.com



METAL -
BRUSHED BRONZE



BLACK WALNUT



MARBLE NERO
MARQUINA



NAPPA LEATHER

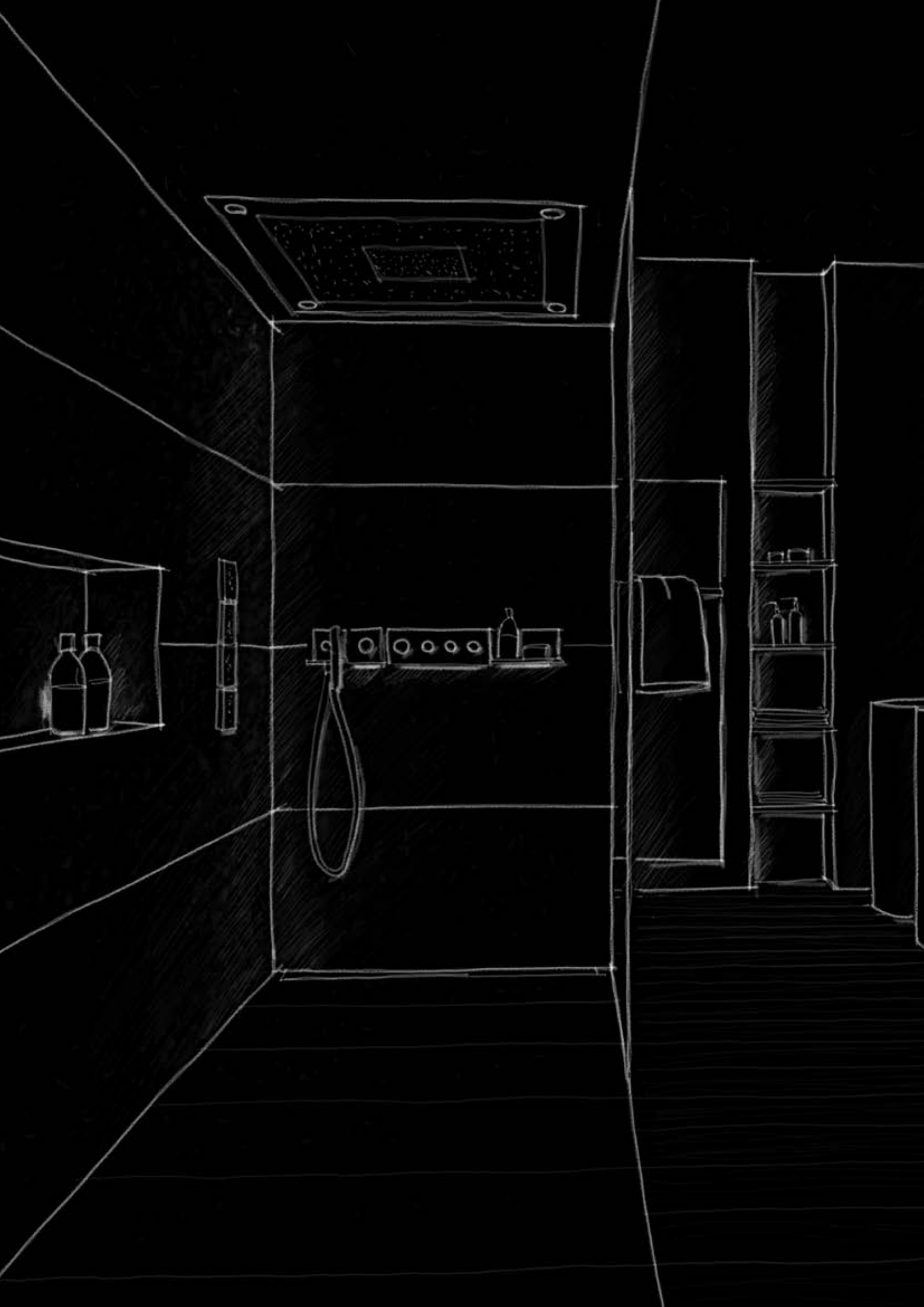

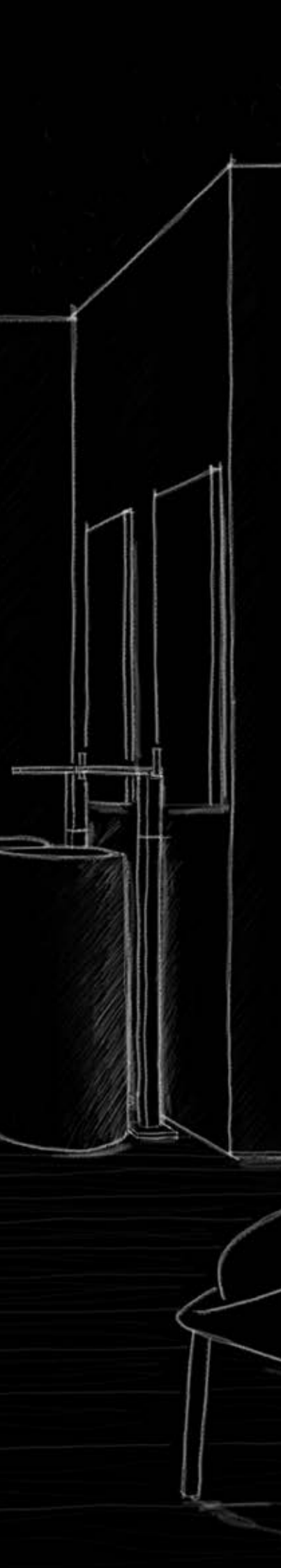

Planning and Installation

Planned down to the last detail

That AXOR continues to set new benchmarks in form and function is made clear with product innovations that are both visual statements and easy to use. AXOR follows this principle even behind walls, with installation options that are thoroughly planned down to the last detail. They are easy to carry out, thanks to iBox universal or specially developed basic sets and thanks to the self-explanatory assembly instructions that come with every AXOR product.

215

SIX EXAMPLES FOR PLANNING AND INSTALLATION:

- / AXOR ShowerCollection: the flexible building block system for creative shower planning
- / AXOR thermostatic module Select: a luxurious way to control the shower preferences of up to five functions
- / AXOR thermostatic mixer 800 for exposed/concealed installation: innovative technology for a flawless fit in any space
- / AXOR thermostatic module Select: simple installation for up to three functions
- / AXOR One thermostatic module: great user comfort thanks to intuitive paddle operation
- / AXOR iBox universal: the multi-talented technology for easy concealed installation

Planning example

AXOR ShowerCollection with AXOR ShowerHeaven 970/970 3jet, with lighting:

The AXOR ShowerCollection is a flexible, building block system for creative shower planning. The corner installation offers a shower experience that surrounds you completely, above all, with the three different AXOR ShowerHeaven spray modes. Two shower modules are used as body showers. Centralized control of all shower elements is realized in the AXOR thermostatic module. The elements can be used individually or together.

- / All three spray modes of the ShowerHeaven 970/970 3jet can be easily controlled with the thermostatic module 360/120
- / All of the showers can be operated outside of the wet zone
- / Water temperature can be set as desired before showering
- / The hand shower module can be operated easily from the shower entry area, making it ideal for cleaning the shower

216

Products

ShowerHeaven 970/970 3jet with lighting

10623800

Thermostatic module 360/120

for concealed installation square for 3 functions

10751000

Basic set

10750180

Shut-off valve 120/120

for concealed installation square

10972000

Basic set

10971180

Hand shower module 120/120

for concealed installation square

10651000

Basic set

10650180

2x Shower module 120/120

for concealed installation square

28491000

Shelf 240/120

40873000

Basic set

40878180

Flow diagrams

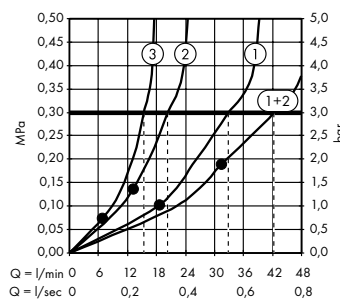

ShowerHeaven 970/970 3jet

with lighting

10623800

- ① Rain
- ② RainAir
- ③ Mono

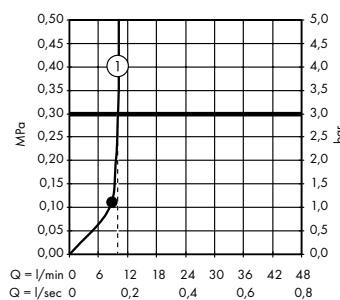

Shower module 120/120

for concealed installation square

28491000

- ① Rain

Function guaranteed starting at *. Consumption data is measured in practical use with the respective mixer/valve for concealed installation.

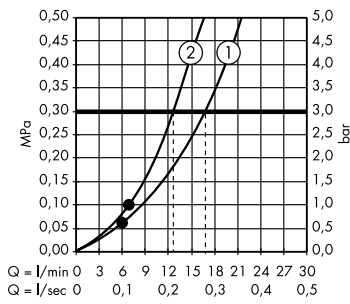
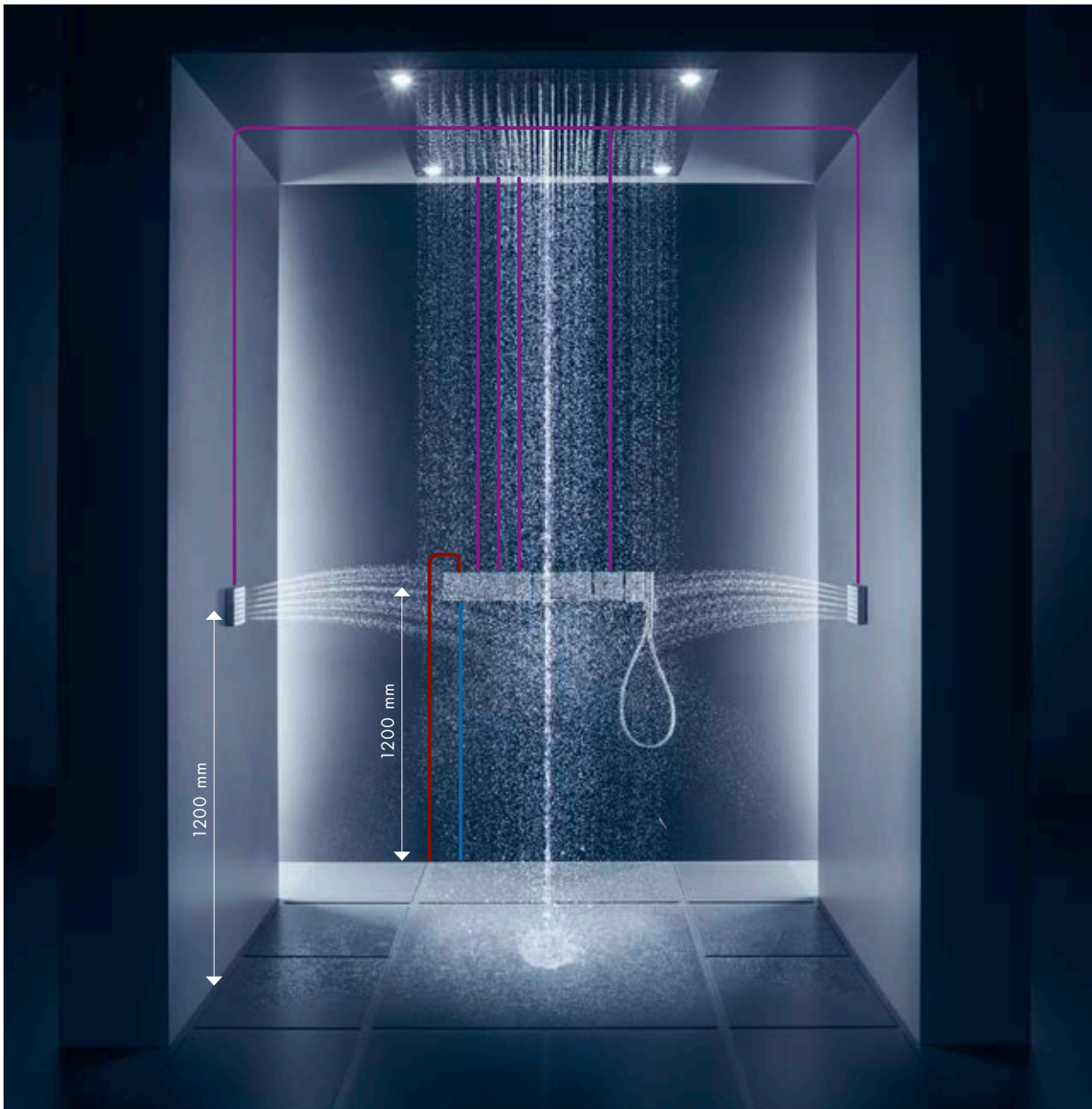

Hand shower module 120/120
for concealed installation square
10651000

- ① Rain
- ② RainAir

Dimension drawings

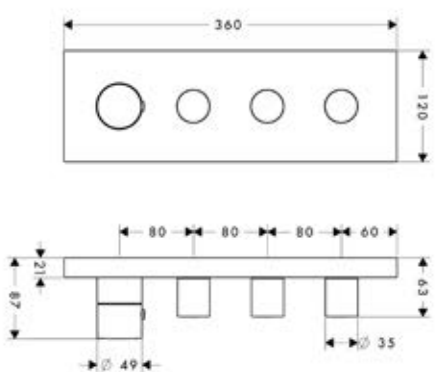

Thermostatic
module 360/120
for concealed installation
square for 3 functions

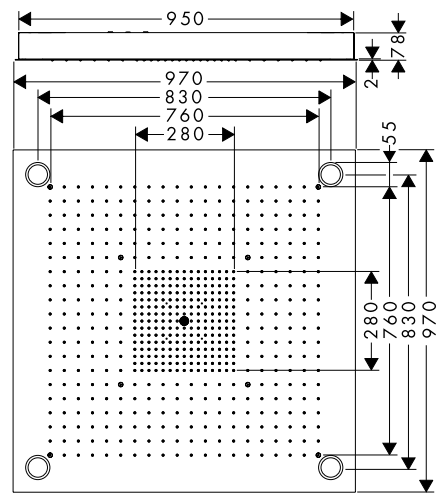

ShowerHeaven 970/970 3jet with lighting

Planning example

AXOR Select concealed installation 670/90 thermostat module for 5 consumers with AXOR ShowerHeaven 1200/300 4jet, with 3,500 K lighting:

Luxurious operation. The thermostatic module Select has a minimalistic look and is the central element for controlling all spray modes and functions individually or in combination. Safe, secure and easy installation with the basic set. A perfect combination partner for AXOR ShowerHeaven 1200/300 4jet.

- / It's easy to control all four spray modes of the AXOR ShowerHeaven 1200/300 4jet with the thermostatic module Select 670/90
- / All of the important functions are brought together in one elegant, concealed thermostat: user control, temperature regulation and water flow.
- / The large Select buttons for controlling the spray modes and functions offer easy, intuitive operation
- / The hand shower is added to the thermostatic module via a porter with an integrated hose connection

218

Products

ShowerHeaven 1200/300 4jet with lighting 3500 K

10628000

Basic set

10922180

Thermostatic module Select 670/90

for concealed installation for 5 functions

18358000

Basic set

18313180

Baton hand shower 2jet

28532000

Metal effect shower hose 1.25 m

28282000

Flow diagrams

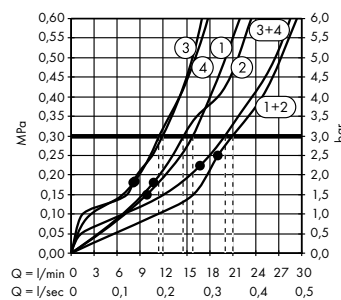

ShowerHeaven 1200/300 4jet

with lighting 2700 K

10628000

- ① Rain
- ② Mono
- ③ PowderRain, inside
- ④ PowderRain, outside

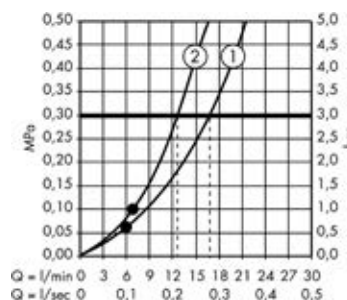

Baton hand shower 2jet

28532000

- ① Rain
- ② Mono

Function guaranteed starting at •. Consumption data is measured in practical use with the respective mixer/valve for concealed installation.

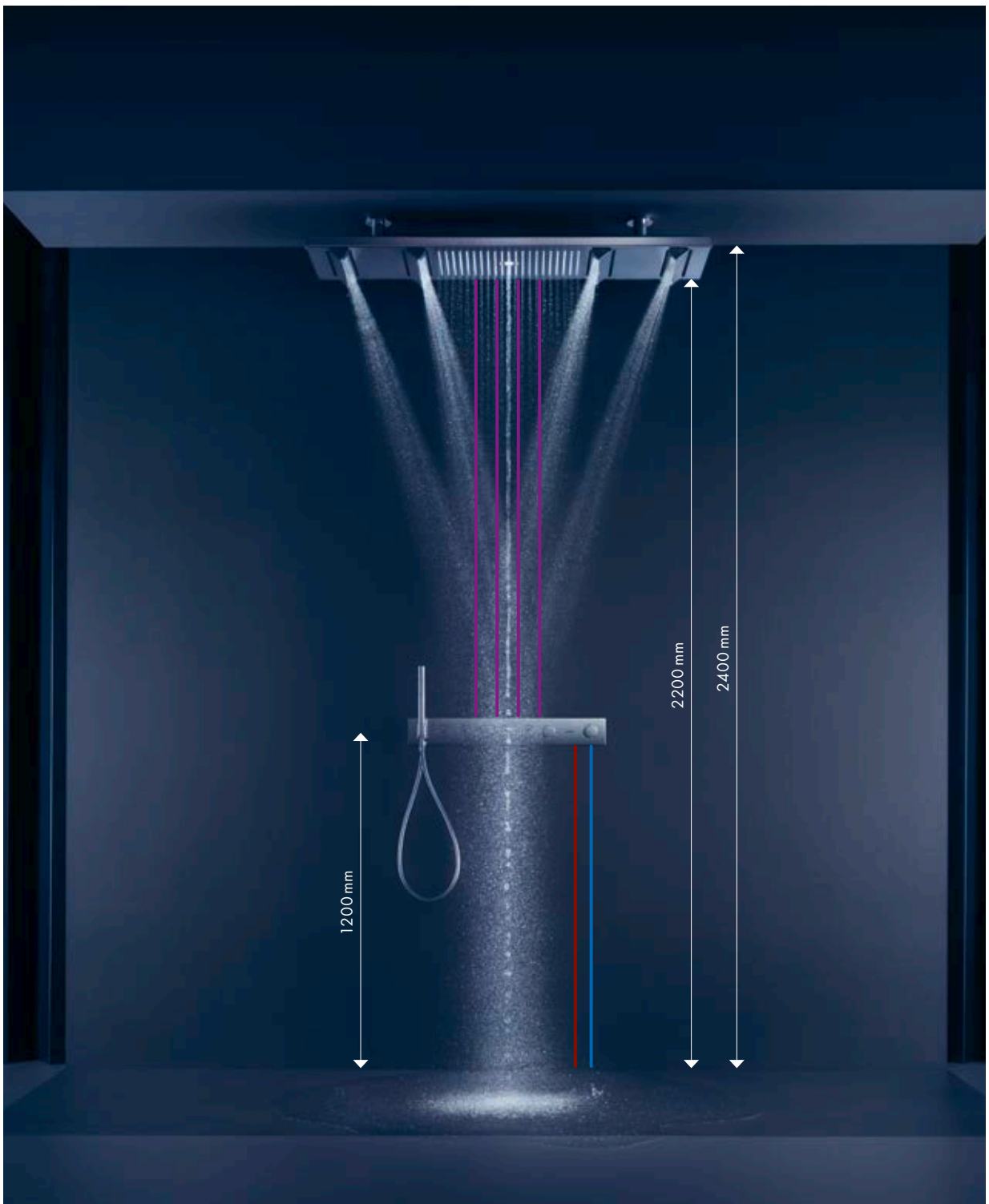

Dimension drawings

ShowerHeaven 1200/300 4jet with lighting 3500 K

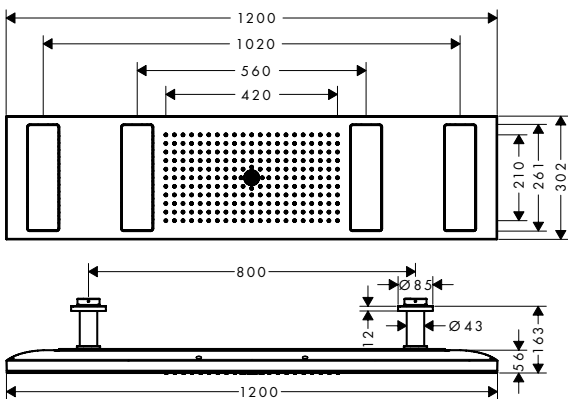

Thermostatic module Select 670/90 for concealed installation for 5 functions

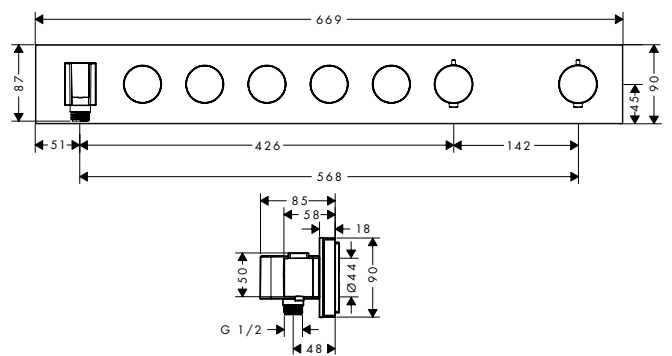

Planning example AXOR thermostatic mixer 800 for exposed/ concealed installation with AXOR overhead shower 350 1jet with shower arm:

Innovative technology enables a sophisticated corner installation (exposed or concealed) of the overhead shower and thermostat. An elegant exposed product in its design, it features a practical shelf. The technical details are hidden in the wall, invisible. Required for installation is the special basic set for the AXOR thermostatic mixer 800 for exposed/ concealed installation for 2 functions.

- / The pipework is hidden completely in the wall thanks to innovative concealed installation technology
- / Thermostat with high quality glass shelf with an exposed design
- / Intuitive Select technology: it's easy to switch the overhead and hand showers on and off with the Select buttons

220

Products

- Overhead shower 350 1jet with shower arm
26034000
- Thermostat 800 for exposed/ concealed installation
45440000
- Basic set
45442180
- Baton hand shower 2jet
28532000
- Shower hose 1.60 m
with volume control
28128000
- Shower holder
27515000

Flow diagrams

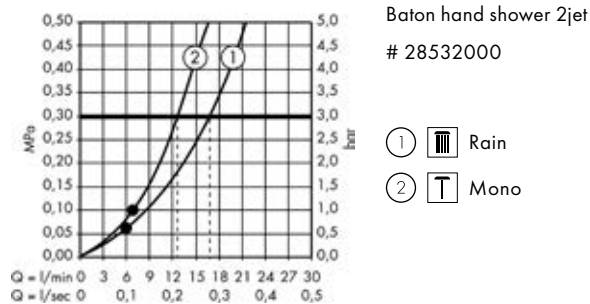
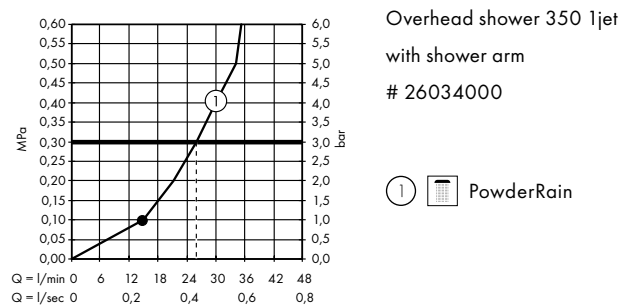

Function guaranteed starting at •. Consumption data is measured in practical use with the respective mixer/ valve for concealed installation.



Dimension drawings

Overhead shower 350 ljet with shower arm

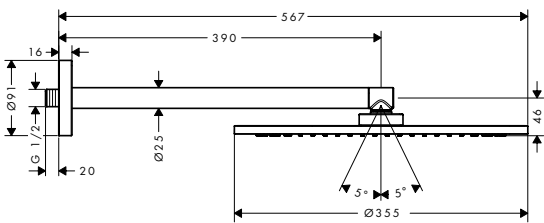

Thermostat 800 for exposed/concealed installation

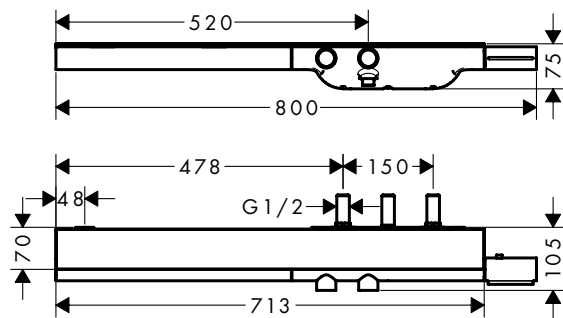

Planning example

AXOR thermostatic module Select for 3 functions

with AXOR overhead shower 300/300 2jet with shower arm:

Clean design for the shower thanks to the slim form of the AXOR thermostatic module Select. Combined with the AXOR overhead shower 300/300 2jet, the innovative PowderRain and Intense PowderRain spray modes provide a highly sophisticated shower experience. The thermostat module with Select technology is used to control the spray modes. It's easy with the intuitive operation of the Select buttons. The special basic set makes it easy to install the thermostat module.

- / Central control with a thermostat: Select buttons for the spray modes, rotary knobs to regulate temperature and water flow
- / Easy to operate thanks to Select technology

222

Products

Overhead shower 300/300 2jet with shower arm

35318000

Basic set 2jet

35361180

Thermostatic module Select 530/90

for concealed installation for 3 functions

18356000

Basic set

18311180

Baton hand shower 2jet

28532000

Metal effect shower hose 1.25 m

28282000

Flow diagrams

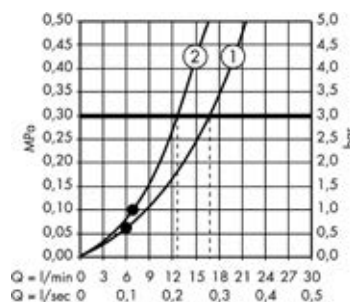
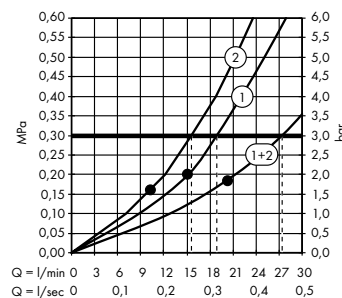

Function guaranteed starting at •. Consumption data is measured in practical use with the respective mixer/valve for concealed installation.



Dimension drawings

Overhead shower 300/300 2jet with shower arm

Thermostatic module Select 530/90 for concealed installation for 3 functions

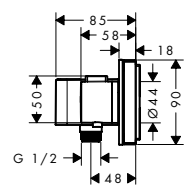
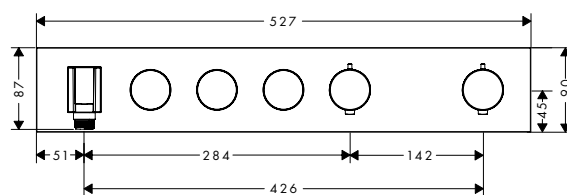
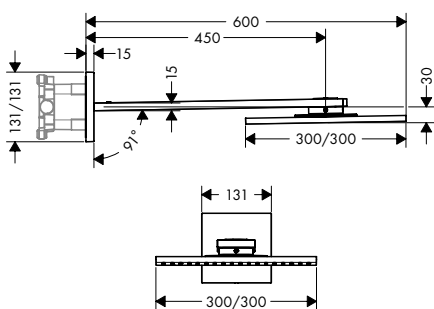

Planning example

AXOR One concealed installation thermostat module for 3 consumers, AXOR One 280 2jet overhead shower with overhead shower and 75 1jet overhead shower:

The shower scenario consisting of two overhead showers and a hand shower offers versatile use and brings the private spa idea as a central element into the bathroom. The compact, shoulder-high shower head is ideal for a quick shower without washing your hair, the wall-mounted overhead shower provides a comprehensive shower experience, and the hand shower is within easy reach. All three consumers are conveniently operated via the AXOR One thermostat; temperature and volume regulation are controlled centrally via a knob.

- / All-in-one: Precise control of all consumers through one central thermostat module with Select technology
- / With EcoSmart technology for reduced water and energy consumption
- / Easy cleaning with QuickClean and removable overhead shower: limescale residues are easy to wipe off on the water nozzles
- / Innovative combination of the Rain (outer ring) and PowderRain (inner ring) spray modes

224

Products

Overhead shower 280 2jet with shower arm

48492820

Basic set for overhead shower 2jet with shower arm

35361180

Overhead shower 75 1jet EcoSmart with shower arm

48490820

Thermostatic module for concealed

installation for 3 outlets

45713820

Hand shower 75 1jet EcoSmart

48651820

Porter unit

45723820

Metal effect shower hose 1.25 m

28282820

Shut-off valve for concealed installation

45771820

Shelf

42844820

Flow diagrams

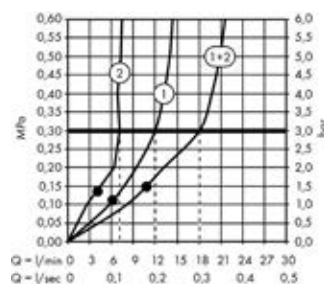

Overhead shower 280 2jet

with shower arm

48492820

① Rain

② PowderRain

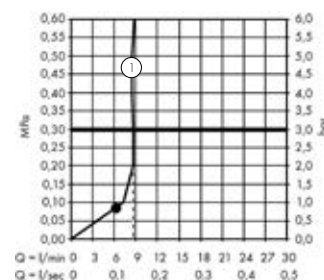

Overhead shower 75 1jet

EcoSmart with shower arm

48490820

① PowderRain

Ab • ist die Funktion gewährleistet. Die Verbrauchswerte wurden praxisnah mit dem dazugehörigen Mischer/Unterputzventil gemessen.

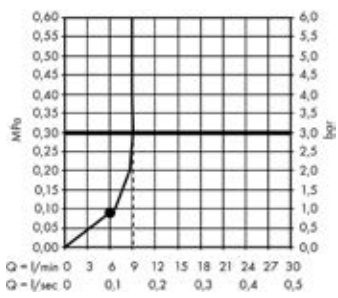

Hand shower 75 1jet EcoSmart
48651820

① PowderRain

Dimension drawings

Hand shower 75 1jet EcoSmart

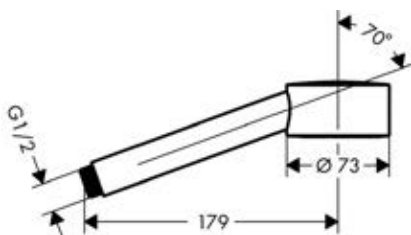

Overhead shower 280 2jet
with shower arm

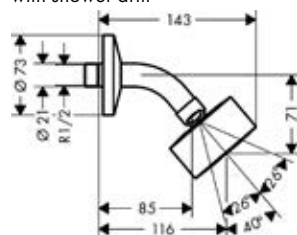

Overhead shower 75 1jet
EcoSmart with shower arm

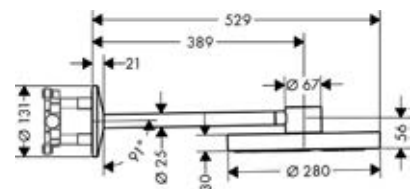

Planning example

AXOR One concealed installation thermostat module for 2 consumers and AXOR One concealed installation 280 1jet shower pipe:

The AXOR One shower pipe is the perfect all-in-one combination of overhead and hand shower, as well as wallbar and wall connection, and offers an immersive shower experience combining the Rain and PowderRain spray modes. The integration of the wall connections ensures a streamlined, tidy appearance. The thermostat module is the ideal aesthetic addition with maximum ease of use thanks to Select paddles, and temperature and volume regulation via a central handle.

- / Control of all outlets or functions through one central thermostat module
- / Parallel and intuitive operation of overhead and hand shower
- / Overhead shower with innovative combination of both Rain (outer ring) and PowderRain (inner ring), spray modes, hand shower with PowderRain
- / Reduced design by integrating the wall connection into the shower pipe
- / With pivoting shower arm for flexible direction of the overhead shower, and thus individual use of space

226

Products

Showerpipes 280 1jet for concealed installation
48790670

Basic set for showerpipe
48798180

Thermostatic module for concealed installation for 2 outlets
45712670



Basic set for thermostatic module
45710180

Bath towel rail 600 mm
42860670

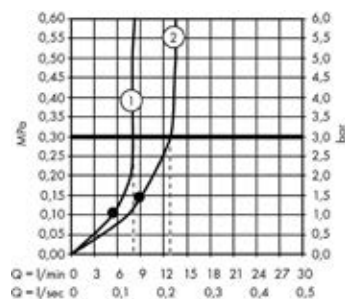
Flow diagrams



Showerpipes 280 1jet for concealed installation
48790670

- ①  PowderRain
- ②  Rain/PowderRain

Function guaranteed starting at •. Consumption data is measured in practical use with the respective mixer/valve for concealed installation.

Planning example AXOR One thermostatic module for concealed installation for 3 functions with AXOR overhead shower 250 2jet with ceiling connection:

This shower constellation consists of overhead and hand showers, each with two jets. Control is easy with the three large paddles of the AXOR One control element. The AXOR One thermostatic module offers simple control and integrated temperature and water flow regulation in one rotary handle as well as control of the various functions, all in one element.

- / All-in-one: Control of all functions with a central thermostat module
- / Hand shower with two spray modes

228

Products

Overhead shower 250 2jet with ceiling connection

35297000

Basic set

26434180

AXOR One Thermostatic module for concealed installation for 3 functions

45713000

Basic set

45710180

AXOR One Hand shower 2jet

45720000

AXOR One Porter unit

45723000

Metal effect shower hose 1.25 m

28282000

Flow diagrams

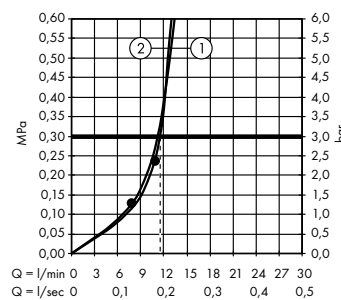
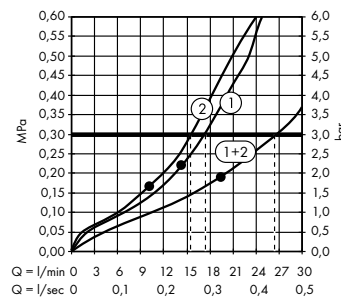

Function guaranteed starting at •. Consumption data is measured in practical use with the respective mixer/valve for concealed installation.

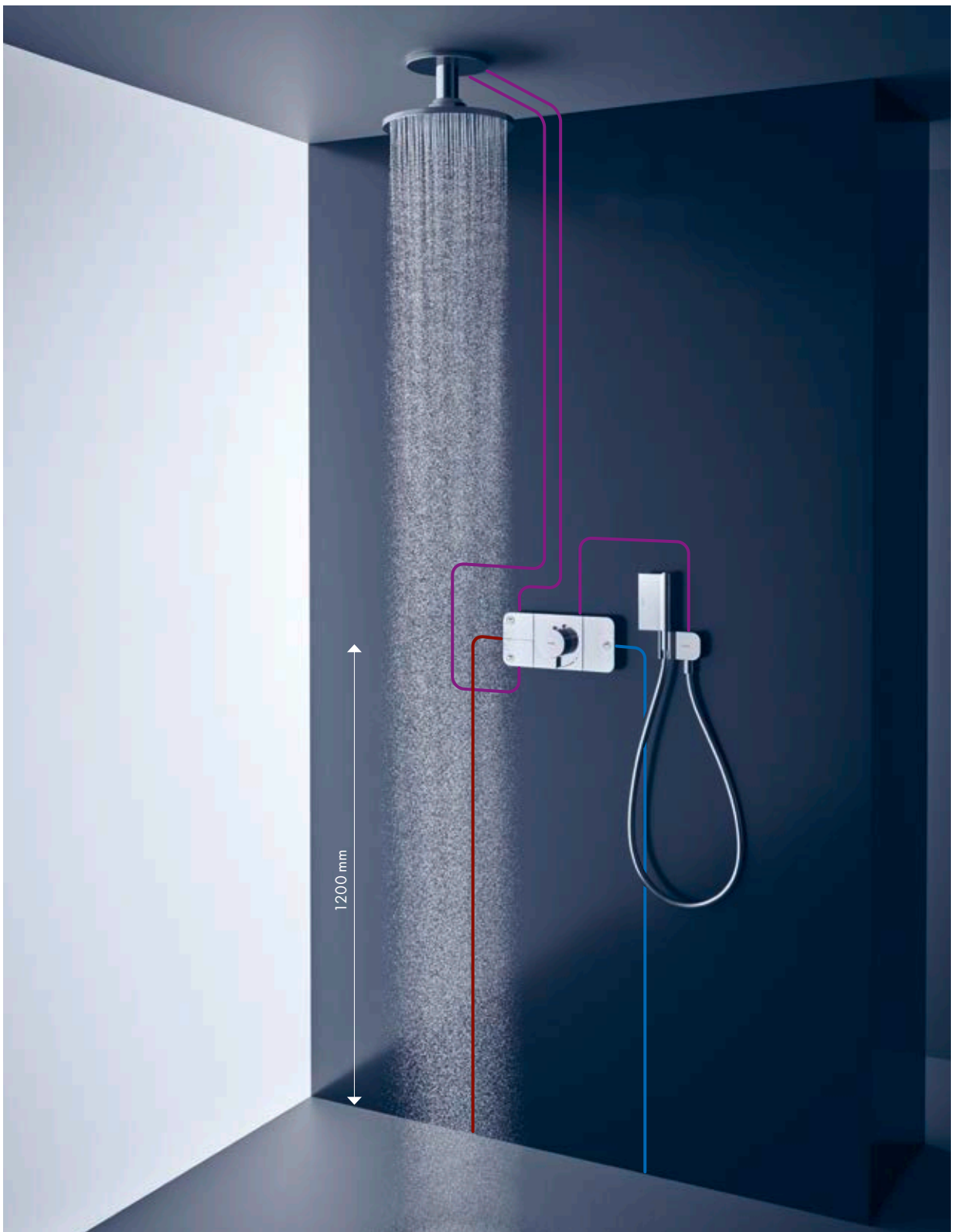

Dimension drawings

Overhead shower 250 2jet with ceiling connection

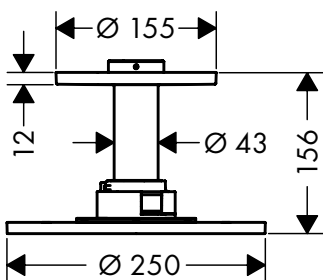

Axor One Thermostatic module for concealed installation for 3 functions

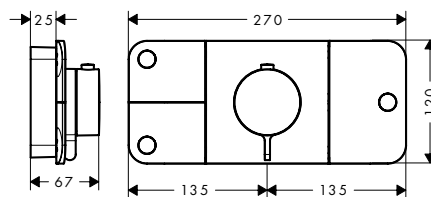

Planning example

AXOR Citterio concealed installation single-hole bath tub faucet with lever handle, AXOR 300/300 1jet overhead shower with shower arm and porter unit 120/120 with 2jet manual shower:

This shower situation consists of an overhead shower with one spray mode and a 2jet manual shower, which are conveniently controlled via the diverter in the single-lever bath tub faucet. The overhead shower with PowderRain brings relaxing, gentle showering experiences to the bathroom, while the hand shower with Rain and Mono spray modes provides refreshment and selective deceleration. The single-lever bath tub faucet with lever handle contributes to the consistent bathroom design, perfectly matching the AXOR Citterio lavatory faucets, which also feature the flat and ergonomic lever handle.

- / Using the bath tub faucet, two outlets or functions can be controlled without a thermostat solution
- / Spa experience: The PowderRain spray mode in the overhead shower gently envelops you in a cocoon of water
- / Less cleaning for the overhead shower thanks to integrated ServiceCard with dirt trap screens, jets that disappear into the spray disc after the water is turned off, and QuickClean function
- / Nice and tidy: Combination of shower support and wall connection in one porter unit

230

Products

Overhead shower 300/300 1jet with shower arm
35314330
Porter unit 120/120 with baton hand shower 2jet and shower hose
12626330
Single lever manual bath mixer for concealed installation with lever handle
39455330
Basic set iBox universal 1/2" and 3/4"
01700180

Flow diagrams

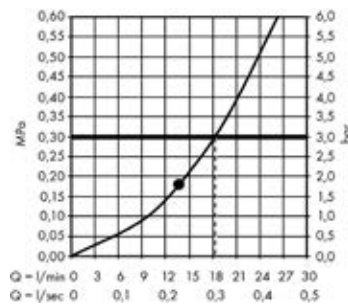

Overhead shower 300/300 1jet with shower arm
35314330

①  PowderRain

Function guaranteed starting at •. Consumption data is measured in practical use with the respective mixer/valve for concealed installation.

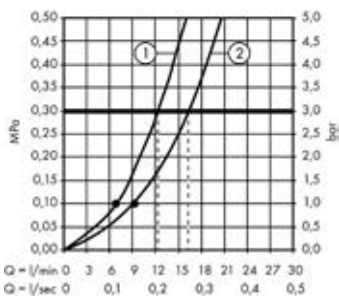
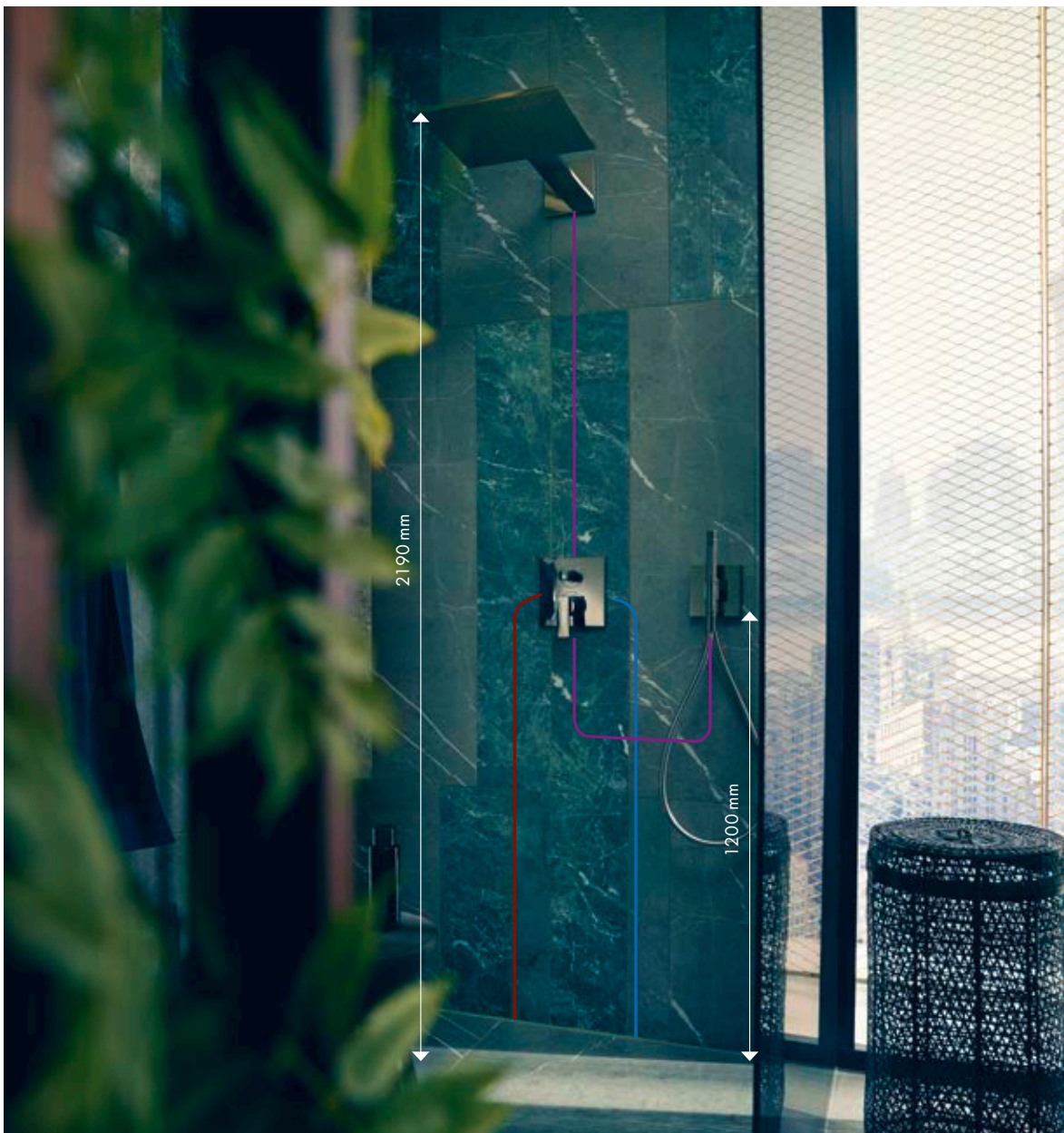

Porter unit 120/120
 with baton hand shower 2jet
 and shower hose
 # 12626330

- ①  Rain
- ②  Mono

Dimension drawings

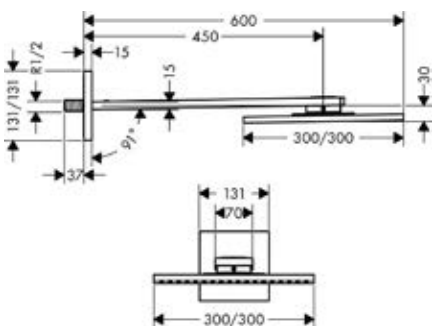

Overhead shower 300/300 1jet
 with shower arm

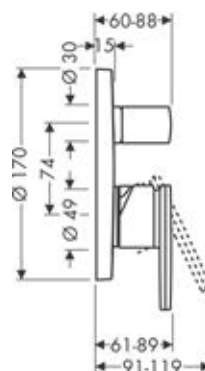

Single lever manual bath
 mixer for concealed
 installation with lever
 handle and integrated
 backflow prevention

Planning example AXOR ShowerSelect thermostatic mixer for 1 function with AXOR Citterio E shower set:

Well above the standard for concealed installations, the iBox universal is the perfect basic set for AXOR ShowerSelect products and offers maximum flexibility in bathroom planning. In combination with the AXOR ShowerSelect thermostatic mixer and the AXOR Citterio E shower set, it creates a shower solution that captivates users with its clean design and high technical precision.

- / Universal application of the iBox as a basic set
- / The iBox universal is suitable for use in private and public spaces and meets common standards worldwide
- / Simple overall look: The technology disappears elegantly into the wall
- / With preinstallation, there is more time available to select the fittings
- / Space-saving solution for greater freedom of movement when showering
- / Replace fittings during renovation without problems
- / Simple, quick installation
- / Safe and secure: a concealed installation solution proven over 18 years of use

232

Products

Shower set 0.90 m with hand shower 120 3jet
36735000
Thermostat for concealed installation
softsquare for 1 function
36705000
Basic set iBox universal
01700180
Wall outlet round
27451000

Flow diagrams

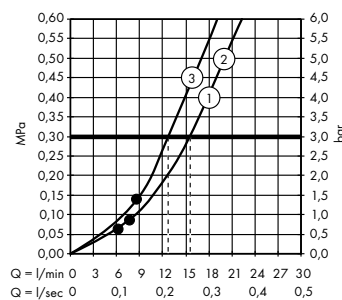

Shower set 0.90 m
with hand shower 120 3jet
36735000

- ① RainAir
- ② Rain
- ③ WhirlAir

Function guaranteed starting at •. Consumption data is measured in practical use with the respective mixer/valve for concealed installation.



Dimension drawings

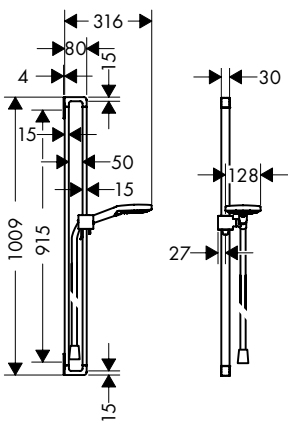

Shower set 0.90 m
with hand shower 120 3jet

Thermostat for concealed installation
softsquare for 1 function

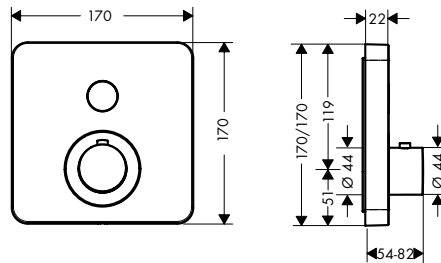

The checklist: We've thought of everything.

Be perfectly prepared as you start your planning and consultation conversation with your customer. The checklist helps you to address all of the important points. From room design to the water experience, water consumption and accessories to installation and technology.

1 Bathroom Design

- / Bathroom type

New Renovation
 construction
- / Bathroom size

- / Style

Avant-garde
 Modern
 Classic
- / Material(s) used in the bathroom

- / Color concept for the bathroom

- / Shower size

234

2 Shower planning

- / Shower form

Tiled Shower tray
- / Drain

Channel Trap
- / What is the ratio of tile to joint compound if walls are tiled?

- / Are the protected zones for electronic installations taken into account?









Yes No
- / Is ceiling height sufficient?
(e.g., for overhead showers, shower pipes)

Yes No

- / Placement of towel rack within reach? Yes No
 - / Accessories necessary in the shower? Yes No
 - / If yes: Which products? Shelves
(e.g., for shampoo and shower gel)
 Towel rack
-

3 Water and control comfort

- / Is a shower pipe/shower column desired and can it be used? Yes No
- / Is an overhead shower desired and can it be used? Yes No
- / If yes: Which type of installation is desired for the overhead shower? Ceiling connection
 Wall connection
 Integrated in the ceiling
- / Which form of overhead shower is desired? Round Angular
 Softsquare
- / How many spray modes are desired with the overhead shower? 1 2 3 4
- / Which spray modes are desired with the overhead shower?

<input type="checkbox"/>		<input type="checkbox"/>		<input type="checkbox"/>	
<input type="checkbox"/>		<input type="checkbox"/>		<input type="checkbox"/>	
<input type="checkbox"/>		<input type="checkbox"/>		<input type="checkbox"/>	
- / Is a hand shower desired? Yes No
- / If yes: How should the hand shower be attached? Wall rod with integrated shower holder
 Single shower holder
 Porter unit
- / How many spray modes are desired with the hand shower? 1 2 3

- / Is saving water important? Yes No
 If yes: Use EcoSmart products.
- / Which type of installation is desired for the control element? Exposed
 (e.g., thermostats, shut-off valves) Concealed
 Exposed/concealed
- / Which control concept is desired? By pressing Select buttons
 By rotating
- / Should it be possible to reach mixer/set water conditions without getting in contact with water? Yes No

4 Product modification

- / Is an AXOR FinishPlus surface desired for the products? Yes No
- / If yes: Which surface finish is desired? _____
- / Are customized product modifications by AXOR Signature service required or desired? Yes No

 - Personalized inscriptions
 - Length modifications for products
(e.g., shortening/lengthening)
 - Handle modifications
 - Integration of structures
 - Use of special materials such as wood or marble
- / Other requests or ideas: _____

5 Installation Planning

- / Is the required water pressure sufficient for the planned users? Yes No
- / Are the pipes the right size(s)? (inflow/outflow) Yes No
- / Is enough hot water available for the product? Yes No
- / Are the products suitable for use with a flow heater? Yes No
- / Can the handles be retrofitted? (Sturdy substructure?) Yes No

6 Notes

Large empty rectangular area for notes.

Inspiration

**At home in luxurious bathrooms
all over the world.**

In demand worldwide, AXOR faucets and showers can be found in the most prestigious hotels and restaurants and most luxurious apartments, houses and villas. What unites these places is the exceedingly high standard they set for design, quality, customization and sustainability.

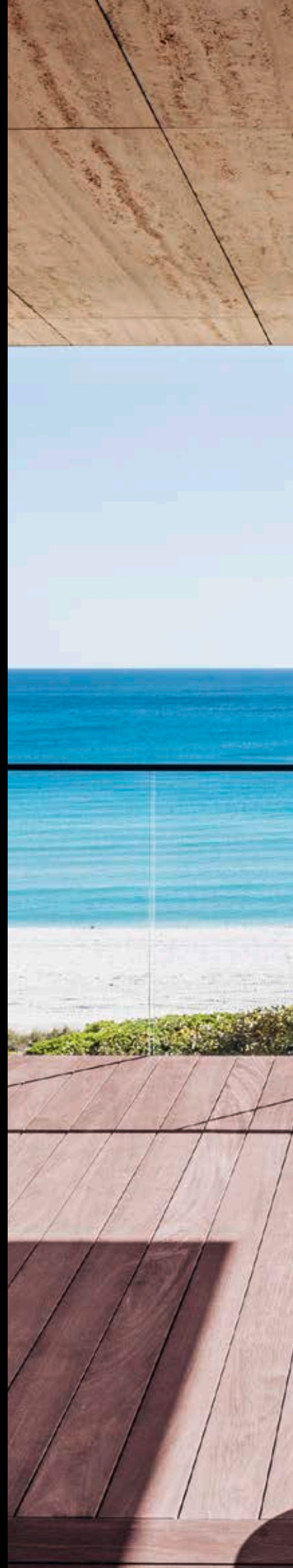



Lily of the Valley, La Croix-Valmer / France

A hotel of the future in the middle of the outdoors

The Lily of the Valley in La Croix-Valmer is a dream of nature and freedom above the Mediterranean Sea. With a mission to imagine a paradise on earth, designer Philippe Starck created a hotel that guests can explore all year round – a warm and soothing atmosphere to find relaxation and harmony.

The sense of serenity and wellbeing at Lily of the Valley extends to the bathrooms and spa area – all in marble and flooded with light. For the faucets, Philippe Starck chose the AXOR Citterio collection in classic chrome. At the sink, the monumental AXOR Citterio single-hole lavatory faucet stands out with its enormous height. At the bath, the wall-mounted three-hole bath tub faucet with hand shower – unobtrusive in its elegance – fits perfectly into Philippe Starck's extraordinary interior concept, both classic and timeless.



240



“THE LILY OF THE VALLEY IS A PARADISE ON EARTH WHERE LUXURY COMES FROM ITS HONESTY, ITS QUALITY, AND ITS GENEROSITY; CONCEPTS AND VALUES THAT HAVE ALSO ALWAYS BEEN A PART OF AXOR.”

Philippe Starck



Architectural concept and artistic direction: Philippe Starck
Collection: AXOR Citterio
Surface: Chrome

Laurichhof, Pirna / Germany

A runway for individuality



At the gateway to Saxon Switzerland and close to the Elbe metropolis of Dresden, the Laurichhof invites you to a one-of-a-kind stay. On a fallow family plot, Annette Katrin Seidel, together with her son Franz Philip Seidel, made her long-cherished dream project a reality that expresses her more than thirty years of experience as an interior designer and architect. The result is the Designhotel Laurichhof with 27 individually furnished suites that invite you to see and experience, to wonder and admire, to relax and recover. The bathrooms play an elementary role in this. The spacious rooms reflect the design idea of the suites through the choice of materials, color scheme and, last but not least, the selection of different AXOR faucets and showers.

“WHAT MAKES AXOR SUCH A GOOD FIT FOR THE LAURICHHOF IS THE BRAND’S HIGHLY VERSATILE COLLECTIONS, WHICH GAVE US MAXIMUM DESIGN FREEDOM. WE WERE ABLE TO CHOOSE THE FAUCETS TO PERFECTLY MATCH THE INDIVIDUAL SUITE CONCEPTS.”

Annette Katrin Seidel, interior architect, designer, and owner of the Designhotel Laurichhof



241



Architect: Seidel+Architekten
Collections: AXOR Citterio, AXOR Citterio M, AXOR Urquiola, AXOR Starck, AXOR Starck Organic, AXOR Montreux, AXOR Massaud
Surfaces: Chrome, Brushed Nickel

Arte Surfside, Miami/USA

Nuanced execution of compact luxury

Designed by Antonio Citterio Patricia Viel's multidisciplinary architecture and interior design practice, Arte Surfside's sculptural, 11-story residential complex with direct access to the beach embodies a key principle of compact luxury: it provides communal amenities that enhance the resident experience while creating private living space. The residential units, meanwhile, reflect another aspect of compact luxury, which Citterio describes as "the need for personalized, private spaces that make creative use of their dimensions."

Antonio Citterio worked exclusively with AXOR products in the Arte Surfside. In the bathrooms, he chose AXOR Citterio E faucets, a collection distinguished by the elegance with which it balances opposites.



242



"DESIGNERS' EFFORTS SHOULD BE DIRECTED TOWARD MINIMIZING THE EFFECT OF CORRIDORS AND CIRCULATION AREAS, TO PERCEIVING THE SPACE AS IF IT WERE AS WIDE AS POSSIBLE. AND THEN TOWARD ADDING DETAILS, LIKE THE ONES WE'RE WORKING ON WITH AXOR IN THE BATHROOM, THAT GIVE A GREAT SENSE OF QUALITY."

Antonio Citterio

Architect: Antonio Citterio
 Collections: AXOR Citterio, AXOR Citterio E,
 AXOR Starck, AXOR Universal
 Surface: Brushed Bronze

The AUDO, Copenhagen / Denmark

A hybrid space for hospitality and encounters



In Nordhavn, Copenhagen's old industrial harbor, new life has been breathed into a neo-baroque building from the early 20th century. The Audo celebrates and hosts human encounters in the global, digital age. Bjarne Hansen, founder of Danish design firm MENU, and Jonas Bjerre-Poulsen, co-founder of Norm Architects, conceived The Audo as a hybrid space, a platform for bringing local and international creatives together. International visitors, however, will appreciate it first and foremost as a one-of-a-kind hotel. Through the choice of materials and colors, each room evokes a different mood. AXOR Uno harmonizes with all of them – whether in Brushed Black Chrome for a “lunar” ambiance or in Brushed Bronze for a “deep forest” atmosphere. Other finishes include Brushed Brass and Stainless Steel Optic.

243

“WE WERE THRILLED WITH ALL THE WONDERFUL FINISHES AXOR HAD TO OFFER. WE WANTED A DIFFERENT MATERIAL AND COLOR PALETTE FOR EACH FLOOR AND ROOM.”

Jonas Bjerre-Poulsen, co-founder of Norm Architects



Architects: Norm Architects
Collections: AXOR Uno, AXOR
Showers, AXOR Citterio
Surfaces: Brushed Black Chrome, Brushed
Bronze, Brushed Brass, Stainless Steel Optic

De Gulde Schoen, Antwerp / Belgium

Coming home in luxury



"WE MAKE SURE OUR GUESTS FEEL AT HOME. THAT INCLUDES HAVING A LUXURIOUS AND REJUVENATING BATHROOM EXPERIENCE WITH HIGH-QUALITY AXOR PRODUCTS."

Family Dembélé

Flanders' most dynamic design hotel, the Suite Hotel Gulde Schoen, can be found in the heart of Antwerp, in one of the city's oldest buildings, constructed in 1493. An historic building with a name that refers to a golden shoe could not find more appropriate owners than star footballer Moussa Dembélé, his mother Tilly and his sister Assita. The trio gave the building an extensive renovation, transforming it into a high-end suite hotel. Today's visitors will be seduced by an elegant but subtle blend of old and new, noticeable from the inner courtyard to the cloistered arcades to the stone-sculpted frieze framing the gilded entrance. For bathrooms in keeping with De Gulde Schoen's atmosphere of urbane sophistication, the hoteliers opted for AXOR Citterio E in the finishes chrome and Brushed Brass at the washbasin, bath and shower.

244



Collections: AXOR Citterio E, AXOR ShowerSelect, AXOR Accessories
Surface finishes: Chrome, Brushed Brass

The Retreat at Blue Lagoon, Grindavik/Iceland

Water meets wellness in a one-of-a-kind destination

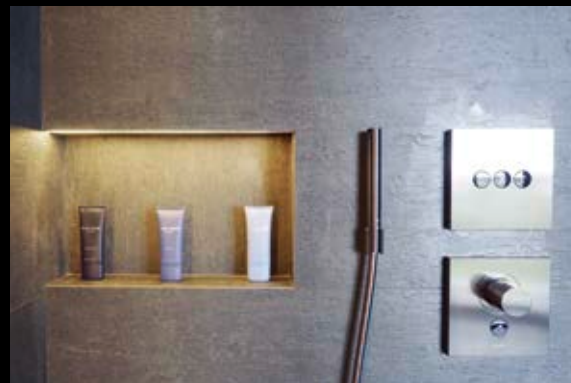

At the Retreat at Blue Lagoon Iceland, earth, water and design come together as never before. An 800-year-old lava vein runs through the heart of the complex, and the rock's unique qualities are everywhere incorporated into the architecture. But the real star is the water. Created in a tectonic realm of searing heat and immense pressure, the mineral-rich water of the Blue Lagoon is fabled for its healing properties and otherworldly beauty. This water completely surrounds the Retreat's 62-suite luxury hotel, to stunning effect. And the special relationship with water continues indoors, where bathrooms are equipped with AXOR Starck and AXOR Showers products in Chrome and Brushed Black Chrome.

245



“THE RETREAT IS BUILT INTO AN 800-YEAR-OLD LAVA FLOW AND WE WANTED THE DESIGN TO CELEBRATE THAT. THE FIREPLACES ARE MADE OF LAVA ROCK, AS ARE THE TABLES. WE SELECTED CUSTOM FAUCETS BY AXOR TO FIT THE OVERALL MOOD WE WISHED TO CREATE.”

Sigurdur Thorsteinsson,
Chief Design Officer, Design Group Italia

Collections: AXOR Starck, AXOR Showers
Surface finishes: Chrome, Brushed Black Chrome

Private apartment, Prague / Czech Republic

Modern luxury in a discreet location

The "Golden House" – as it is also called – is located in the 6th district of Prague and offers modern luxury in a discreet location. Designer Ivanka Kowalski created an intimate yet opulent atmosphere by delicately combining different materials. The highlights of this property are the private spa and en suite bathrooms. These spaces are adorned by various AXOR collections, each of which makes a unique contribution to the overall aesthetic. For the bathroom products from the AXOR Urquiola and AXOR One collections, Kowalski chose Brushed Gold Optic, Polished Gold Optic, and Brushed Bronze from the wide range of exclusive AXOR FinishPlus surfaces. At the sinks, AXOR Urquiola faucets and their artfully eclectic combination of shapes create a lively contrast to traditional wood and stone. The floor-standing thermostat becomes an extravagant, sensuous statement at the bath tub.

246



Interior architect: Ivanka Kowalski
 Collections: AXOR Urquiola, AXOR One,
 AXOR Showers, AXOR Starck
 Surfaces: Brushed Gold Optic, Polished
 Gold Optic, Brushed Bronze



“WITH ITS AVANTGARDE
 DESIGNS AND AN
 UNPARALLELED RANGE OF
 EXCLUSIVE FINISHES, THE
 AXOR BRAND HAS BECOME
 THE PERFECT PARTNER FOR THE
 BATHROOM AND KITCHEN.”

Ivanka Kowalski, interior designer

The Alchemist, Copenhagen / Denmark

A journey that touches all the senses



An evening at The Alchemist is sure to be a memorable one. Since opening in 2019, the Copenhagen restaurant has earned two Michelin stars for its highly creative, technically complex dishes and choreographed dining experiences. Head chef and co-owner Rasmus Munk worked with Studio Duncalf to reinvent the space – a former Royal Danish Theatre workshop for stage construction – by employing live performers and using visual technologies for Munk’s self-designed “holistic cuisine.” The Alchemist takes guests on a journey that touches all the senses – through neon halls, past walls spray-painted with graffiti and a 42-foot-tall wine cellar. If the journey takes you to the bathrooms or kitchens, you will discover not just one, but three AXOR collections.

“IN THE ALCHEMIST, WE HAVE THE OPPORTUNITY TO TAKE OUR GUESTS OUT OF THEIR NORMAL WORLD AND TRANSPORT THEM TO A DIMENSION OUTSIDE OF TIME AND SPACE.”

Rasmus Munk, head chef and co-owner



Interior architects: Studio Duncalf
Collections: AXOR Starck Organic,
AXOR Citterio, AXOR MyEdition
Surfaces: Brushed Black Chrome

Private residence, Falsterbonäset / Sweden

A unique villa on the Swedish coast



The Falsterbonäset peninsula on the southwestern tip of Sweden is home to some of the most beautiful beaches and luxurious villas in Scandinavia. When developers and interior designers Linda and Mikael Bergman decided to design a private home there, they had one goal: to build an energy-efficient, high-end residence with the latest smart home technology. The result – just 100 meters away from the famous Ljunghusen Beach – is a clean, classic design in a modern mix of materials. Featuring walnut, brass, marble, and polished concrete, the interiors were thoughtfully conceived, tastefully curated, and appear to flow almost seamlessly into one another, with no visible thresholds or unnecessary frames. When designing the bathrooms, the owners selected and customized various AXOR products to align with their sophisticated vision.

248

“AFTER VISITING THE AXOR BOOTH AT A LEADING TRADE SHOW, WE FELL IN LOVE WITH AXOR’S PRODUCTS. THE BRAND OFFERS EXACTLY WHAT WE WERE LOOKING FOR – EXCEPTIONAL, ENERGY-EFFICIENT PRODUCTS WITH BEAUTIFUL, INDIVIDUAL FINISHES.”

Linda Bergman, interior architect and owner



Interior architects and owners: Linda and Mikael Bergman
 Collections: AXOR Starck Organic, AXOR Showers, AXOR Starck
 Surfaces: Brushed Black Chrome, Brushed Red Gold

La Réserve Eden au Lac, Zurich / Switzerland

The imaginary yacht club on the lake



With the impetus of La Réserve and the vision of excellence from owner Michel Reybier, the Eden au Lac Hotel has reinvented itself as La Réserve Eden au Lac Zurich, a new five-star property in Zurich. The hotel has been completely redesigned to offer an elegant and timeless experience in the heart of an imaginary yacht club, just as Philippe Starck imagined. In doing so, the French designer envisioned the renovation as minimal but not minimalist, based on a quest for the structural soul and raw poetry of the site, uncovering the light and maximizing the architectural volume. The hotel is filled with rewarding surprises and mind games, sophisticated and carefully curated objects and materials that give the place a unique poetry and charm.

249



“LA RÉSERVE EDEN AU LAC ZURICH IS LIKE DANCING TO ROCK ‘N’ ROLL WITH THE QUEEN. EVERYTHING IS CLASSIC – AND YET NOTHING MORE. A TIMELESS COCKTAIL OF CREATIVITY, CLASSICISM, AND INTELLIGENCE, JUST LIKE SWITZERLAND ITSELF.”

Philippe Starck

Architectural concept and artistic direction: Philippe Starck

Collections: AXOR Citterio, AXOR Starck, AXOR Starck Organic accessories

Surface: Brushed Chrome

Treehouse, London / Great Britain

Luxurious sanctuary above the city



"THE INTERIOR IS BASED ON A MID-CENTURY STYLE LEANING TOWARDS THE PLAYFUL, NOSTALGIC DESIGN THE TREEHOUSE NAME IS KNOWN FOR. BECAUSE OF ITS NOVEL DESIGNS, OUTSTANDING QUALITY, AND A WIDE RANGE OF DIFFERENT STYLES, THE AXOR BRAND WAS THE IDEAL PARTNER FOR THE BATHROOMS."

Audrey Sterk, interior designer

The Treehouse Hotel successfully combines the charm of the past with the comfort and convenience of the present. The hotel's eclectic vibe extends into the en-suite bathrooms, where faucets from the AXOR Montreux collection combine the charm of a bygone era with contemporary technology and modern finishes. All AXOR Montreux faucets are used here in Brushed Black Chrome – one of the exclusive AXOR FinishPlus surfaces.

250



Interior architect: Audrey Sterk
 Collections: AXOR Montreux
 Surface: Brushed Black Chrome

Banyan Tree Anji, Huzhou/China

A meditation on luxury



THE ARCHITECTURE OF THE BANYAN TREE ANJI REFLECTS LOCAL CULTURAL FEATURES AND THE SURROUNDING LANDSCAPE. AXOR CITTERIO ADDS TO THIS THOUGHTFUL STYLE THROUGH ITS ELEGANT, ELEMENTAL SHAPES.

It is only an hour's drive from the teeming metropolis of Hangzhou, yet the Banyan Tree Anji is worlds away. Surrounded by bamboo forests, tranquil lakes and gentle valleys, this exclusive eco-resort exudes the calm and seclusion of a monastery—albeit a very luxurious one. The property includes a golf course, an equestrian club and a spa. With its unique blend of contemporary décor and Buddhist tradition, the Banyan Tree Anji offers visitors a holistic space in which to retreat from the hectic pace of daily life. No wonder the bathrooms feature products from the AXOR Citterio collection.

251



Project participants: Greentown

Collection: AXOR Citterio

Surface finish: Chrome

PREFACE

Modern bathrooms are more than a simple summary of planning and installation of tabs, showers and matching piping systems. Today, the room – which was for a long time a purely functional wet cell and neglected in terms of design – became a place of wellbeing, relaxation and regeneration. Besides the upgrade in both functional and product aspects, the bathroom developed over the last years more and more into a reflection of individual (composition) requests and (design) preferences. Along with this development, sales persons and planners are confronted with new demands. They need to advise discerning customers not only in terms of the right product choice but also in regards to the aesthetic impact of a bathroom.

This design lexicon serves both consultants and enthusiasts as a reference guide for design. However, it is not a claim to completeness – but as a competent basis for a professional dialogue it explains the different expressions in the areas of architecture, design and of the different AXOR collections.

ACCESSORIES

Borrowed from the French and used mostly in the plural, this collective term describes additional/ decorative and/or functional equipment (from French “accessoires”). “Accessory” actually describes a not-necessary-but-adapted-to-the-fashion style, arrangement or image composition additional by-product. Accessories are used primarily in fashion design to set accents that are highly trend-dependent. In interior design, accessories such as textiles, decorative items, pictures, candles, vases and, in the bathroom, additional functional (soap) dishes, towels, mirrors or purely decorative design elements for the wall are used to achieve consistency of a design concept or look (compare: AXOR Accessories).

AESTHETICS/AESTHETIC

Aesthetics is the theory of the sensual perception (from Greek “aesthesis” = perception). Therefore, it doesn't mean beautiful by itself, but the doctrine of regularity and basics of the beautiful (harmony), as can be perceived in nature or art. Additionally, it analyzes whether the aesthetic features can be seen as objectively given or if beauty is in the eye of the beholder. This approach focuses less on personal taste than on the generally human or generally societal perception of what is considered as beautiful (compare: Golden Ratio). In everyday speech, the term is often used as a synonym for beautiful, balanced, tasteful, appealing. In the true sense of the word, however, “aesthetic” describes all the characteristics which we experience with our senses and which determine how we perceive our environment and objects – particularly whether we perceive them as beautiful or ugly. Balanced proportions, regular or layered forms and harmonious

color combinations are often considered particularly aesthetic, beautiful and pleasant. How we perceive beauty may be partly rooted in biology, but it is also acquired culturally and sociologically (as defined by our personal environment). The same number of factors determine whether we perceive a design as being aesthetic or aesthetically convincing or not. In some cultures, clean and harmoniously proportioned shapes are considered beautiful while in other cultures however beauty means rich ornamentation.

AMBIENCE

The term *ambience* (from Latin “ambio” = surrounded or enclosed) means “surrounding environment” or “setting” in the sense of a special atmosphere exuded by a decór, a space or a piece of art. In interior design, *ambience* is achieved through a targeted aesthetic presentation and stands for the atmosphere created by a space.

ARCHETYPE

The term “archetype” comes originally from psychology or philosophy and – referring to psychologist C. G. Jung – indicates the primal image of being or original images, which are the compositions of (pre) human fundamental experiences and, all in all, represent the basis of the personality structure. An archetype (from Greek “arche” = beginning, and “typos” = imprint; meaning original model, mold) can be a shape that is embedded in our cultural memory and which is an example of or a symbol for a specific function. For many of us, a house still has a rectangular ground plan and a gabled roof, even though a variety of other house types exist today. Philippe Starck employed a bucket of water as an archetype. The water pump served him as an original

model for the faucets of the AXOR Starck Collection. In product design, archetypes are forms that establish or embody a new product class. For example, cross handles represent the handles of a faucet (compare: AXOR Montreux), the Porsche 911 represents the sports car, Mart Stam's "S34" steel-tube chair (1926) represents the cantilever chair, etc.

ARCHITECTURE/ARCHITECTONICS/ ARCHITECTONIC

Architecture (from Greek "arché" = beginning, origin, base, the first, and "téchne" = art, handcraft) describes the crafted occupation and aesthetic examination of humans with the built space. Architecture is one of the oldest art forms of human civilization. Today, the lines between functional buildings and architecture are blurred: Department stores, concert halls, churches and apartments are regarded equally worthy of the design process. The connection between architecture and geometry is as old as architecture itself. The concept of architecture as both shell and constructive framework, and the idea of axiality (alignment with the axes), find their source in Roman antiquity. These principles have been continually refined and are today expressed through modern construction materials such as steel framing, concrete, glass etc. Space is designed in terms of dimension, proportion, form and composition. The term "architectural" covers anything that creates a space and cannot be dissociated from it – both in terms of construction and design. In product design, architectural composition is based mostly on geometric (basic) shapes. Straight, non-expressive, purist forms, without superfluous elements and avoiding all unnecessary technical-appearing style, is perceived as architectural. These objects appear as architectural, structural elements that are weight-bearing, functional and adjusted to the room. Such objects are often connected to the wall or the floor and/or provide structure to the room. They usually are not decorative but simply draw attention to the essentials (compare: AXOR Edge). The term "architectonics" is often used synonymously but can describe – to differentiate it from "architecture" – a structure, order or system. It may be used in regards to not only to the art of building but also to the human body or even to a poem.

ASYMMETRY/ASYMMETRIC

"Asymmetry" describes the missing of symmetry or an inequality. It is only used in those areas when there is also a symmetry (symmetry/symmetric). The adjective describes the non-symmetrical or unequally balanced elements in a composition. This manifests itself in an

optical or even a structural imbalance in constructed objects or products. Some artists intentionally choose an asymmetric composition to create tension (compare: AXOR Urquiola). In deconstructionism, asymmetrical constructions are aimed at confusing the beholders' sense of balance and their perception of harmony by using technical illusions.

AUTHENTICITY/AUTHENTIC

"Authenticity" (from Greek "authentikós" = genuineness, reliability, credibility) means originality. An authentic object is always an original or a product identical to the original (as in serial production). In the figurative sense, a form or an attitude can be described as authentic (as opposed to cursory, superficial, ostensible) even though it might not characterize the original, as long as it carries its original quality and its true identity. Content can be considered as authentic when both aspects of perception – the instant semblance and the actual existence – are found to be in accordance. A form or a re-design is considered authentic when it is used or designed in the sense of the original (compare: AXOR Montreux).

AVANT-GARDE/AVANT-GARDIST

In the broadest sense, avant-garde (from French: "l'avant-garde" = front guard) assigns a leading or pioneering role. Avant-gardists are people who start new, pathbreaking developments. In contrast to a trendsetter, who starts only short-term styles, changes started by avant-gardists have a more basic and long-term effect. The term "avant-gardist" therefore doesn't describe one particular style, but rather an artistic or intellectual attitude. With respect to art history, the term "avant-garde" describes artists whose ideas and works are ahead of their time. In the history of visual art, stands for a new art movement of the (early) 20th century. The term is closely connected to modernity. The original aim of all avant-gardist movements (mostly elitist, perceiving themselves as forerunners) was always a change in society. Most avant-gardist movements in art emerged at the beginning of the 20th century from artists' communities sharing an idealistic belief in progress – such as Italian futurism, Russian constructivism, De Stijl (Holland) or German Bauhaus. All such movements reject the prevailing aesthetic norms of their time. Today, "avant-gardist" generally means a demonstratively modern artistic expression aimed to provoke and consequently to promote a new aesthetic or social ideal. Even if this ideal can't be realized, avant-gardist movements often

have a significant influence on prevailing trends in fashion, art and design of their time.

AXOR FINISHPLUS

AXOR term for (color) finishes. AXOR FinishPlus finishes are characterized by their exceptional brilliance, high durability and exclusiveness. Customers can choose from a large variety of standardized finishes such as Brushed Redgold, Polished Black Chrome or Polished Gold Optic. Therefore, AXOR FinishPlus finishes contribute significantly to the possibilities for personalization of the bathroom (compare: Individualization). The finishes are particularly resistant and much harder than a galvanized fixture. They also have an excellent color brilliance since they receive through the Physical Vapor Deposition (PVD) process an additional metal layer.

AXOR SIGNATURE

A service from AXOR that realizes individual demands such as lengthening, shortening or individual marking/labelling of AXOR mixers, showers and accessories. AXOR Signature plays an important role within the AXOR individualization philosophy since the service turns a bathroom product into a unique piece that fulfills the exclusive aesthetic taste of the customers (with own logo or emblem) or that is adapted to meet requirements that are based on special spatial conditions (longer shower arm for an extra-high ceiling) (compare: Individualization).

BELLE ÉPOQUE

This is the period of time around the turn of the 19th to the 20th century. It lasted about 30 years generally in Europe and affected especially the life in metropolises such as London, Paris and Vienna. A new cultural life started in cafes, lounges and theatres of the European core countries because of economic and technical progress, which affected also art, fashion, architecture and technology. This new era of freedom was also characterized by optimism and the new possibilities that technical improvements generated. Cabarets served as stages for writers, artists and actors; Parisian bohemians met in night clubs and variety theatres like the famous Chat Noir or Moulin Rouge in Paris. A parallel development took place in fine arts. During the time of Belle Époque, impressionism led to Jugendstil (Art Nouveau) and to Cubism. The most important representatives were Paul Cézanne, Gustav Klimt or Pablo Picasso. In architecture, a separation from historicism occurred; the builders first preferred Jugendstil and then turned over to the New

Objectiveness, which started in the early 1920's. The most important representative of Jugendstil in architecture was Paul Möbius. (compare: Jugendstil).

CLASSIC (DESIGN CLASSIC)

The adjective classic describes a design which is typical for its time, but at the same time so perfect and pure that it seems timeless. Classic designs are considered harmonious and complete – regardless of the associated epoch or art form. Therefore, classic is defined as timeless, in contrast to the circumstantial nature of fashion. Classic works can be found in music, architecture, fashion, art, design, literature and all other areas. Colloquially, the term classic is used today as a synonym for typical/original. Classics are considered to be perfect in form and pattern formation, making them likely to be imitated. Neither unique in form nor the first of their kind, these imitations can never reach the quality of the original. In design, a classic is the closest to a formal ideal, the basic idea, even if it is not as functionally perfect as its successors. Ray and Charles Eames's Lounge Chair is considered a modern design classic, while the iPod is presently called a classic. In bathroom design, the 1994 AXOR Starck collection is a design classic – primarily because the faucet, with its joystick handle and minimalistic design, was revolutionary in terms of operation and form. In visual arts and applied arts as well as in architecture, the Classic Modern Style includes artists and works of the period between the two world wars. The Bauhaus is one of the most important examples of this style.

CONCEPT/CONCEPTUAL

A concept (from Latin "conceptum" = the combined) is a plan, an idea for a project which can have artistic or creative value, even before its material realization. A concept advances the idea and incorporates many factors which play a role in the realization, success and the impact on, for example, a new product. The design constitutes the last stage of a concept. The concept is still recognizable in the completed product as the underlying formal and functional idea. In design, the quality of the concept is determined by how long-lasting the design is and how well the product functions. However, concept design, inspired in the seventies by concept art, concerns intellectual debate about the object, as opposed to its practical value for provoking a reaction from the user. Elements of concept design can be found in Radical Design and Antidesign, employed by Italian groups like Alchimia and Gaetano Pesce and in the New German Design (compare: New Design). Awards such as the Red

Dot Award: Design Concept illustrate how valuable concepts are – even before their realization – evaluating and acknowledging new design concepts, innovations and prototypes believed to be the precursors of tomorrow’s important products. AXOR information: With WaterDream, AXOR has established a format through which conceptual potential can be achieved without compromising design creativity (similar to concept cars of the automobile industry). Space, water and humans are the only parameters for the international architects and designers. With no constraints related to market conditions, radical freedom and thinking emerges about product design and bathrooms. Many of the AXOR WaterDreams (established in 2000) turned into visionary products for the bathroom, such as the AXOR Massaud collection, the AXOR shower products designed by Front, or the AXOR LampShower designed by Nendo, which is itself is a new interpretation of the interaction between light and water.

CULTURE/CULTURAL

In our society, we use the word cultural (from Latin “cultura” = development, cultivation, processing) to describe institutions and activities such as the theatre, music, visual arts, literature, but also education and research. However, these are only the most visible expressions of a culture, which develops within a community and which is determined by a range of factors like language, politics, law, family structures, social values, religion and social conventions, education, communication skills, consumer habits, housing and health care, social behavior and responsible attitude towards individuals, society and the environment. The complex phenomenon of cultural identity within Europe is closely connected with the concept of civilization (as a theoretical counterpoint to the state of nature, instinctive behavior and the abuse of power). This led to a new image of state and society in the context of the Enlightenment in the 18th century. Culture can also be understood as a concept which works on both a large and a small scale. It is not only individuals who develop their own culture, but also every community – on the basis of familial, societal and religious structures. An individual might express their cultural identity through appearance, bodily care, or style of living. In larger structures, this identity presents itself as a subculture. In companies, concepts of morality, history, brand-specific standards of quality and sustainability, as well as socially responsible behavior all result in a culture which contributes to the formation of a specific identity (compare: Corporate Identity).

DESIGN

Design has two principal meanings: design in the sense of a process (a drawing, an idea or a creative concept) and design in the sense of an outcome (the appearance of the created object, as well as the international language of larger structures, such as those encountered in interior design and architecture). The word design (from Latin “designare” = to signify) has been introduced into many different languages. Following its emergence in craftwork, design has since flourished in numerous other fields. The most important are product design (e.g. furniture and household objects), industrial design (a term largely applied to the design of industrially manufactured products in contrast to craftwork, but is sometimes used to describe specialized machines for industrial production), interior design (special art), graphic design (means of visual communication such as typography, prints, marketing materials), corporate design (establishment of an homogeneous visual appearance), communication design, packaging design, fashion and textile design, color design, etc. Design encompasses not only the visual or aesthetic presentation of an object or a communication medium, but also its functionality and construction. The tasks of a designer include product conceptualization, selecting and processing materials and choosing the production technique. Design influences ergonomics and the usability of everyday equipment and devices, and understanding the emotional component of a design has become crucial in today’s world. A well-designed product performs optimally, clearly conveys its function and is a pleasure to use both in the short and the long term.

DIAMOND CUT

Within gemology, cutting is a process which intensifies the shine of a gem by bringing out the optical effects which are already inside the stone. The cut of a diamond decides upon its brilliance. Cutting is part of the 4Cs (Color, Clarity, Cut, Carat) and is the most remarkable of these four criteria. The higher the quality of a cut, the more the stone shines. Only the perfect cut can bring out the unique fire of a diamond. There are around 1500 types of diamond cuts. The brilliant cut is considered the best-known cut, which is composed of small, polished surfaces. These surfaces, or facet (from French “facette” = bevel; partially polished, flat surface) cuts are used for other gemstones, mirrors and glass, and even to create special forms (compare: AXOR Starck V). AXOR information: For AXOR Edge, the diamond cut describes the partially refined surface structures

of the faucet. To achieve this texturing, a unique 3D structure is milled into the brass block at the handle or the lower part of the faucet. This structure is created using a diamond-tipped tool, the same one used when cutting diamonds. After that, the block is chrome-plated or refined with one of the AXOR FinishPlus finishes. The entire process creates a surface texture that is a special part of the faucet, standing in the Art Décoratifs cultural tradition.

DISCREET

The term (from Latin "decentia" = decency/civility) is a synonym for sensitive or befit. In aesthetics, this term means unobtrusive and restrained, describing the subtlety of a design element or an entire composition, in which no singular element dominates.

DYNAMICS/DYNAMIC

Dynamics (from Greek "dynamiké" = powerful or "dynamis" = power) refers to the movement of bodies under the influence of a force. The term dynamic usually describes the character of a person, an environment or an object and means that someone or something is full of energy, agile and light. It is often used to describe the character of a person, an environment or an object. Dynamic therefore signifies the opposite of static. However, dynamics can also mean the inner movement of a piece of art, a design object, a building or a room design. A sense of dynamism or movement can be achieved through deliberate nuances, rhythms or organic, sweeping lines.

ECLECTICISM/ECLECTIC

Eclecticism (from Greek "eklektos" = selected) is a design principle which draws upon different objects, styles, materials, elements or philosophies and combines them to create something new. As an artistic movement and design principle which openly draws upon existing or historic works of art, eclecticism has significantly shaped human creativity for centuries. It also characterizes different periods of European art from historicism onwards. The term eclecticism was used pejoratively in the past, applied to any art that lacked originality. In postmodernism, eclecticism as an art method became important for critical reflection on existing material. In design, the eclectic principle represents a technique to edit or reinterpret (art) quotations, or to create or reinterpret an original (creative and innovative) formal experience. This way, something new arises from established objects. Often, the result is a combination of references and symbols

from the worlds of design and architecture (compare: AXOR Urquiola).

ELEGANCE/ELEGANT

Elegance (from Latin "elegantia" = fine taste or fineness) is associated with a sophisticated, stylish taste which has a distinctive and cultured appearance. People who dress elegantly and furnish their home in an elegant style wish to express a refined, cultivated sense of taste. The elements employed are mostly classical and harmonious, with bold or ornate elements often avoided.

ERGONOMICS/ERGONOMIC

Ergonomic is mostly used as a synonym for anatomically designed or optimal for human use. Ergonomics (from ancient Greek "ergon" = work and "nomos" = rule, law) is concerned with designing a work space that is efficient and gentle on the body. Ergonomic design aims to improve the interaction of man and machine and to create products that are easier to handle and more comfortable to use.

EXTRAVAGANT

The term extravagant means "in an eccentric or exaggerated, overstretched manner purposely different and therefore notable/exceptional". Previously used in a negative sense, extravagant today describes any creation in product design, architecture or interior design that is exceptional, new and unusual, partly futuristic, often made with the purpose to polarize.

FORMAL EXPRESSION

Formal expression describes the way in which an object or a room achieves a certain expression by means of its formal elements. Rooms and objects express themselves in their arrangement and via metaphorical references – for example a handle in the shape of a leaf. The term formal expression is in line with the idea that individual design elements (basic shapes, lines, colors, etc.) can achieve a certain expression through their arrangement – just like the words in a language. An object can therefore be soft or aggressive, expressive or concentrated, discreet or dominant, minimalist or sculptural.

FROG DESIGN

Frog Design is one of the most well-known international design studios. The company was founded under the name "Esslinger Design" in 1969 by Hartmut Esslinger. Working from Altensteig within the Black Forest, Esslinger worked with with Georg

Spreng and Andreas Haug to create the Tri-Bel hand shower, for which Hansgrohe received its first design award in 1974. The studio had its international breakthrough at the beginning of the 1980s, receiving global recognition for its work, particularly the legendary Apple IIc and Apple Macintosh designs. During this decade, the company changed its name to Frog Design and relocated to Silicon Valley. The acronym FROG is an abbreviation for "Federal Republic of Germany". Today, the design studio has offices around the globe.
www.frogdesign.com

GOLDEN RATIO

In art and architecture, the Golden Ratio is the ideal ratio among different lengths of an object or a construction to one another. It is considered the epitome of aesthetics and harmony and was used intuitively long before its formula was discovered. It is argued that the Golden Ratio can be found in many works of the Renaissance artists such as Raphael, Leonardo da Vinci and Albrecht Dürer. The Golden Ratio defines the harmonious partition of an object into a shorter and a longer section in the mathematical ratio of $b:a = c:b$. The ratio of the longer section to the total length is the same as the ratio of the smaller section to the longer one (compare: AXOR Uno).

HAPTICS/HAPTIC

Haptics (from Greek "haptikos" = able to touch) is the study of tactile sense. Through touching surfaces and by being touched, living organisms receive various impressions and information. In design, the haptic perception of an object influences our well-being. Our reactions, whether we experience comfort or disgust, a feeling of warmth or coldness, or a sense of ease or irritation, are intuitive and beyond our control. The term goes back to the German psychologist Max Dessoir. He recommended in his publication "Über den Hautsinn" in 1892 to name the study of tactile senses, following terms such as 'acoustics' and 'optics'. The tactile perception of a surface largely determines our emotional relationship to the object, but also our confidence in its ergonomic quality, for example in that of a chair or a musical instrument. Haptic design principles are used in different areas, e.g. in product packaging haptics (form and surface structure), where it is used as an important recognition factor for a brand. A pleasant tactile experience is a decisive product feature, especially for products which are used several times a day (e.g. bathroom faucets).

HARMONY/HARMONIC

Harmony (from Latin/Greek "harmonia"= agreement, concord) is an aesthetic term for the meeting and coexistence of two or more different but matching parts. These parts complement one another, resulting in a harmonious, balanced appearance. Ideally, all different parts retain their own identity, but join together to form a new unit. In most systems – as in music or color – the individual elements must share a common origin on a deeper level in order to be compatible (such as belonging to the same pitch in music or to the same color category).

INDIVIDUALIZATION

The term (from Latin "individuum" = individual being) has its origins in sociology, and refers to the increased desire in the West for individuals to construct their own identities during early industrialization and modernization. Though the term is used differently in sociology, psychology and economics, at the core it involves freedom of choice. Trend researchers have described individualization as a mega trend, one which affects value systems, consumption patterns and everyday culture. In the product sector, digital technologies such as 3D-printers, the internet, or programs of configuration create new possibilities for individualization. Websites that allow product configuration for vehicles are absolutely indispensable in this sector. Car buyers customize their cars online; choosing motors, colors and equipment packages. Today, product configuration (or customization) has reached nearly every area of everyday life. Food is assorted with different ingredients (My Muesli) and cosmetics are adjusted to the customer's special preferences (My Parfum). Individualization aims to fulfil one's own wishes and desires, allowing them to differ from others and to stand out from the (social) crowd. Interior design individualization – like product design – helps to express unique tastes and exemplifies exclusivity (individuality) (compare: AXOR FinishPlus, AXOR Signature).

INTERIOR DESIGN

The aim of interior design is the artistic furnishing and decoration of a room. Interior design includes technical and structural aspects, as well as aesthetic, artistic expression. According to the BDIA (Bund Deutscher Innenarchitekten – Association of German Interior Designers), the legally protected professional title "Innenarchitekt" in Germany defines the tasks of an interior designer as follows: "The creative, technical, economical, ecological and social planning of interior spaces and connected to that, the

constructional modifications of buildings." Besides the technical aspects, the interior designer creates the sensual perception of a room, which conveys relations and meanings that exceed spatial perception. The representatives of the Bauhaus school sought to tear down the barrier between architecture and interior design. Today, their vision of architecture, interior design, art and product design as one integral task has become very popular once again.

LIFESTYLE

The term lifestyle means individual way of life. In common speech, lifestyle means the cultural form of life of a group of people. Cultural identities that do not refer to an individual are derived from this term and used in common language. In this context, it is common to speak of an American, a Western, or Eastern lifestyle. It not only represents certain values, but also conveys preferences in fashion, music and other areas. Attitudes towards health, professions, free-time, family and the nature of social relationships are also a part of a lifestyle. Lifestyle orientation includes the conscious presentation of one's personality (through cultural and fashion elements) and one's preferred style of accommodation. The ideal of any lifestyle, no matter what its specific orientation, is the creation and communication of individuality. The challenge, it seems, is to find a convincing (authentic) balance between individuality and the prevailing "Zeitgeist" / convention.

LUXURY / LUXURIOUS

Luxury (from Latin "luxus" = richness, excess, opulence) means expenditures and activities which exceed the bounds of what is considered standard or essential in a society. In its positive meaning, luxury is regarded as a desirable situation, in which life is more comfortable for individuals and free from worry. Also, "en vogue" in our society is a luxury which is limited in time and which marks special occasions in life. A clearly negative meaning of luxury, however, is a lifestyle that is superfluous, irresponsible and wasteful. Yet luxury and norms are not to be understood separately from each other. Luxury can be defined as a deviation from a state culturally defined as normal. Against a background of relative wealth on one side and a decrease in quality of life on the other, luxury is less defined by material wealth and instead by immaterial values: personal time, health care, outdoor experiences, family life, space, self-determination, etc. In current discourse, products and services are considered as luxurious when they show unique selling

points, are limited (e.g. Haute Couture), or if they enjoy a collector's item status (such as rare wines).

MINIMALISM / MINIMALIST

Strictly speaking, minimalism isn't a style, but a principle in design which can be used in many different styles. The aesthetic aim in minimalism is a functional and visual result characterized by elegance and a concentrated, controlled use of materials. This is achieved by using only as much material as necessary and by focusing on the core of a project. The motto "less is more" is based on an aesthetic rule used in some Asian cultures, where a strong impression is created through the minimal use of objects, ensuring that superfluous elements do not distract from the central idea. The adjective minimalist is often used as a synonym for clear, simple and reduced. A typical feature of minimalism in architecture and design is the avoidance of using too many features. Minimalist designs typically feature primitive colors (e.g. red, yellow, green, blue) or geometrically primitive forms (e.g. circle, square, triangle). Small dimensions appear in the context of large surfaces and smooth surfaces are often dominant. In most cases, this arrangement is connected with a cool, rational design and a highly functional character. In design, the term minimalism is associated with a fundamental, purist trend that consciously broke away from Studio Alchimia and Memphis in the 1980s. The ideal of minimalism is simplicity. Simplicity means that only a few factors contribute to the creation of a form and that relatively few influences are visible. The most exacting requirements in minimalist design are generated when there is a need to integrate complex components into a simple form in a harmonious, virtually invisible way. Minimalist product design therefore often encloses a complex interior or a complex processing of materials. The aim is to transform complexity (with regard to technical equipment or difficult structures) into a highly sophisticated and organizational form. Japanese designer Shiro Kuramata and French architect and designer Philippe Starck are among the most popular representatives of minimalism (compare: AXOR Starck).

MODERN / MODERNITY

In common usage, the term modern means contemporary, up to date, progressive or in accordance with the latest fashion. However, using the term modern as a synonym for fashionable is reductive. Modern refers to the latest developments in society, science and technology. In design, modern is mostly used in a contemporary context. It is less

common to use the term with reference to Classical Modernity (early 20th century).

MODULE/MODULARITY/MODULAR

A module is a component of a larger system.

Modularization (or the modular principle) refers to partitioning of an ensemble. In modular construction, systems are assembled from standardized individual components. In industrial production, modularization increases efficiency and the resulting modular product offers advantages for the users. Some highly sophisticated and common product lines in the automobile or furniture industry are based on modular construction, which makes it possible to customize a collection, or adjust it to changing circumstances (compare: AXOR ShowerCollection). In architecture, the modular principle offers a lot of advantages – especially in terms of costs and flexibility. Thanks to modern, computer-based production concepts, modular buildings and individualization possibilities or aesthetic designs are no longer considered as insurmountable hurdles.

MONOLITH/MONOLITHIC

A monolith (from ancient Greek “monólithos” = unified stone or one-stone) is a naturally-shaped or carved block formed from one type of stone. Boulders (large, single pieces of stone) or overhanging mountain ledges are considered (natural) monoliths, as are island rocks (e.g. Uluru in Australia) or rock towers (e.g. Angels Landing in the USA). Monoliths created by human hands include stone pillars, e.g. The Obelisk of Axum, Ethiopia, and the Stone of the Pregnant Woman, Lebanon. The latter is one of the largest carved monoliths and was originally planned to be in the temple complex of Baalbek. The adjective monolithic is usually used synonymously for anything consisting in one piece or one block. In architecture, the term refers to buildings (or parts of buildings) that are built out of one single material (stone or cast concrete). Similarly, underground tanks or water reservoir tanks of a single mold are also called monolithic. In general, objects are described as monolithic if they consist of a single part (compare: AXOR MyEdition).

MONUMENT/MONUMENTAL

Important/meaningful memorials, buildings or large paintings are called monuments (from Latin “moneo” = to commemorate sb./sth., admonish, call attention to) and often have the purpose of preserving the memory of historically important people or events. These could be burial mounds (Hågahügel, Sweden),

giant sculptures (Mount Rushmore, USA), or symbolic buildings (Walhalla, Germany). One common usage of monumental is as an adjective for anything reminiscent or serving as a monument, made in large dimensions and therefore very impressive. In architecture, the Neoclassicism of the early 20th century was influenced by the monumental approach to building from antiquity, the Baroque and the Classic. The main building of La Sapienza University (Rome, Italy), the Haus der Kunst (Munich, Germany) or the Michigan Central Station (Detroit, USA) are all examples of this (compare: Neoclassicism). Monumental buildings or furniture have – due to their impressive dimensions – a memorial effect (compare: AXOR Citterio).

NATURAL/NATURE-INSPIRED DESIGN

In common usage, the adjective natural means real, authentic, original and of indigenous origin. This general meaning was coined during the Enlightenment in Rousseau’s philosophy, which accentuated the difference between a natural and a civilized way of life. The use of natural in the sense of biological, non-synthetic and pure only became dominant with industrial development and the introduction of artificial materials and artificially produced food. With the increasing mechanization of our surroundings and a growing sense of alienation from nature and traditions, the idea of a natural environment has come to assume greater prominence as an ideal or utopian state. The term natural describes a state of affairs which hasn’t been altered by civilization or education. In design and architecture, the term natural refers to a process of imitation with the purpose of achieving an overall impression reminiscent of nature, with the aim to create a sense of well-being. When designing an object and when choosing the materials, all human senses are considered; visual and spatial perception, the senses of smell and touch, sensations of warmth and cold and also cultural connotations. Consequently, nature-inspired design is a design principle that uses nature as role model and recreates a sense of nature. Consequently, nature-inspired design products should create an overall natural impression and enhance the feeling of well-being (compare: AXOR Massaud).

NATURALIST/NATURALISM

Naturalism is a movement in literature and art that experienced its zenith from 1870 until 1890. Artists of naturalism had the aim to portray objects as they are; as realistically as possible, convincing in perspective, accurate in every detail and without euphemism. However, accuracy in appearance, carried to

extremes by photorealism, is no guarantee that the message conveyed is genuine or true.

NEOCLASSICISM

Neoclassicism (in contrast to classicism of the late 18th and the early 19th century) is an international architecture trend of the 20th century. The movement turned against Jugendstil and historicism after the First World War and was then characterized by referring to classical style elements and forms. The creators of Neoclassicism studied the buildings of Greek and Roman Antiquity, borrowing and then modifying their clear structure, geometrical layout, monumental appearance and classical order of pillars and gables. Famous buildings in the Neoclassical style of architecture are found in the USA (e.g. 30th Street Station in Philadelphia), in France (e.g. the Palais de Chaillot in Paris), or in Finland (e.g. the Finnish Parliament in Helsinki). A unique neoclassical style with a monumental focus emerged in Germany under National Socialism and in fascist Italy, for example from Albert Speer or Enrico del Debbio. Famous examples in Germany include the Olympic Stadium and the Neue Reichskanzlei. In Italy, examples include the sports facilities Foro Italico in Rome, as well as St. Peter's Basilica and the Basilica of St. Paul in Rome. In Russia, socialist Neoclassicism influences many cities even today: the Moscow State University is one example, as is the House of Soviets in St. Petersburg.

NOSTALGIA/NOSTALGIC

Nostalgia (from Latin *nostalgia* = homesickness, Greek *“nóstos”* = homecoming and *“álgos”* = pain) describes the memory of good times past: a feeling of undefined, retrospective longing which motivates one to recall or revive past styles in art, music or fashion. Nostalgic design or nostalgia is invoked by products, spaces, and music (e.g. by reusing flower power elements of the 1960s, or the music of the 1980s). The focus is on reconstructing a past style as accurately as possible, without adding new elements, or on creating a new style by combining old and new elements (compare: Retro) (compare: AXOR Montreux).

ORGANIC DESIGN

Organic Design is both a style and a principle of design and construction. As a style, it constitutes the polar opposite of geometric, functionalist styles. It is inspired by organic shapes and sometimes also by inorganic, particularly crystalline, structures, both of which appear in nature. Classical features of Organic Design are powerful curves and dynamic, round shapes. Typically, (but not exclusively) amorphous

forms are used which appear natural and symbolize nature. The aim is to achieve a pleasing, natural impression and many organic designs allude to structures that occur naturally. As a design principle, Organic Design can be found in many disciplines and there is no stylistic unity. Organic forms can be found in traditional, high-tech or minimalistic styles. Organic Design is not characterized by stylistic expression, but rather by a principle of construction that imitates nature (e.g. cellular, netted, skeletal, crystalline) and by abandoning classical static weight-bearing structures in favor of a more flexible and elastic construction. What all organic objects have in common is a design that is developed from the inside out and a focus on accentuating expression. Common techniques include asymmetrical construction, flowing lines, soft shapes, directed structures, plastic volumes and dynamic forms. In organic architecture, buildings might appear to grow or they might even appear to have an explosive energy. Frank Lloyd Wright (Guggenheim Museum New York), Eero Saarinen, and Hans Scharoun in Germany each produced ground-breaking work in this field. Today, futuristic buildings by architects such as Frank O. Gehry, Zaha Hadid, or Peter Cook (Kunsthaus Graz) increasingly showcase organic design elements. The most important representatives are Ron Arad, Luigi Colani, Massimo Iosa-Ghini, Ross Lovegrove (seats for Japan Airlines, 2002) and Philippe Starck. Objects designed through Organic Design principles are often shaped ergonomically and made of high-quality, sustainable materials which fit the overall idea of the product (compare: AXOR Starck Organic).

ORIGINAL

The word original (from Latin *“origo”* = beginning) has several meanings. As opposed to a counterfeit, an original is a genuine product or object. As opposed to a copy, an original is a work created by the artist; it is neither changed or replicated. Original can also mean the initial version or prototype; the first version of a text, painting, work of art, or product model. As an adjective, original can also mean innovative, creative, or ingenious. In this context, the adjective original describes something incomparable and exceptional.

PROPORTION/PROPORTIONAL

In aesthetics, proportionality means a ratio of size or length which is particularly pleasing to the eye. In fine arts, proportion is used to measure the ideal ratio of individual parts to one another and to the whole. In architecture, it is the measurement of width, height and depth in relation to the complete building

(compare: Golden Ratio). How we perceive the balance of proportions is not a matter of chance. It is determined by biology, aesthetics and culture. American cars seem overproportioned to Europeans, but still harmonious as a whole. Extra-long necks, considered an ideal of beauty in some African cultures, challenge our perception of proportions. In fashion, taste changes faster than in other areas, whereas in architecture it is relatively more constrained by structural requirements.

PURISM/PURISTIC

Today, the term purism (from Latin "purus" = clear/pure or French "le purisme" = the Purism) is mostly used as a synonym for simplicity and frugality. Purism is a style within the modern art and architecture of the 20th century. It was originally used in the sense of linguistic purism, which advocated a pure, unaltered style, free of any foreign objects. Purists want to keep a cultural characteristic as authentic, original and pure as possible. A strictly classical design can also be considered purist. Purism is therefore always associated with a certain sense of stringency. As a design movement, purism developed from an aesthetic trend which itself derived from Russian constructivism, a style which called for clear, austere art modelled on the basis of purely architectural and geometric forms. The ideal is a composition of elementary geometric forms that avoid purely decorative effects. In contemporary design terminology, purism stands for the extremely reduced use of forms with an almost ascetic character. An ethical component can also be perceived: modesty in outward appearance meant to convey a nearly sacral concentration on intrinsic value. Since purism also represents the ideal of authenticity, nothing is concealed (as opposed to minimalism) to achieve a more homogenous and harmonious appearance. All elements should speak for themselves. Typical features of purism include a minimal combination of materials, untreated surfaces, clarity through sharp lines, geometric or archetypal forms (including traditional, simple forms), strong contrasts with few primary colors and combinations of black, white and grey. Purism is characterized by structure, timelessness and substance (compare: AXOR Uno).

QUOTATION

In general usage, quotation refers to the literal repetition of a part of a text. In the context of art, architecture and design, quotation describes the reclamation of parts of an older work in the process of creating a new one. Quotation is a technique

that has been popular in many periods in art history and was revived in the 20th century, particularly by postmodernists. While in postmodernity quotations were mostly used in an ironic and playful manner, designers in the modern eclectic style employ quotations as a means of deriving new design interpretations and, ultimately, new designs.

SCULPTURE/SCULPTURAL

A sculpture (from Latin "sculpere" = to carve, create, chisel) is a three-dimensional body (mostly a piece of art) which has a powerful and symbolic appearance from several perspectives and which clearly distinguishes itself from its environment (compare: Plastic). A sculptural design element delivers its own, autonomous statement, is independent of its environment and has a strong influence on the viewer's perception of a space (compare: AXOR Edge).

SENSUALITY/SENSUAL

Colloquially, sensuality means turning the senses or the receptivity of the sense organs toward outer impressions. Perception makes it possible for us to distinguish our environment for its materials and forms, and to recognize and categorize things from their characteristics. Often sensuality is associated with eroticism, but also with sensual driving forces, preferences, desires and passions, needs, and feelings of pleasure and displeasure. Sensual as an adjective describes something "happening through or recognizing something by senses" or "belonging to the senses". The term sensual is also used in the context of "concentrating on senses", if the product focuses on the human senses. Design can be sensual, if it attracts someone in an emotional way and if touch, sight and taste are triggered in a positive way. Sensual design is often combined with a comfortable feel and/or balanced look (compare: Golden Ratio) (compare: AXOR Starck Organic).

STYLE

Style is primarily the expression of personality. It is not restricted to individual expression and can also signify the presentation and expression of an epoch (such as Jugendstil), a region (like the Italian "Bel Design"), or an artist/group of artists or designers (Bauhaus, Memphis, etc.). A style is identified by recurring, characteristic features and by a particular choice and use of forms. In fine arts, it is called a style if these features form a pattern that appears in numerous individual works. These characteristics can develop into a personal style (also called individual style) found in art, design or in fashion. However, a

style can be considered archaic, idealist or naturalist, independent of personalities or time periods. In design, the most widely known stylistic categories are functionalist, minimalist, organic and classical.

STYLE MIX

A combination of style elements from different historical contexts (compare: Eclecticism) or from different aesthetic backgrounds. A style mix typically features objects taken from different designs. However, these different styles are not mixed within a product or a collection, ensuring that the individual style remains distinguishable. This is a commonly used method in interior design. Style elements are often used sparingly to establish accents and contrasts, attempting to create tension and challenge familiar perspectives. This lends a distinctive character to a minimalist or purist ambience. The intention is to invite a fresh perspective on objects considered as aesthetic standard-setters due to their immaculate appearance.

SYMBOL/SYMBOLIC

A symbol (from Greek "symbolikós" = identification or identity mark) always carries a meaning. It is an image defined by certain conventions and conveys a meaning that is open to interpretation. Whereas a sign conveys something specific, symbols are complex, representative of something that is imperceptible. Symbolic in this sense means representative or "referring to a deeper meaning". In the context of design, symbols are not employed as direct signs (e.g. as in language theory or with traffic signs), but rather convey an indirect message, as a symbol goes beyond the meaning of the object itself. The meaning of symbols in religions, myths or art often resist translation or interpretation by reason alone. A similar depth of meaning can be found in design, but symbols in design mostly have an emotional function. Either the design itself conveys a familiar, conventional world (such as the wing chair or the AXOR Starck faucet, reminiscent of an old-fashioned pump) (compare: Archetype), or individual design elements stand for different aspects of life – such as the color gold for luxury, chrome for sophisticated technology, or leaf-shaped for nature. The symbolic function of design (as opposed to a mere indication of intended use and operation) becomes apparent in its relation to the social context. For instance, Bauhaus symbolized avant-gardist ideas, functionalism represented industrial progress, country style was a symbol for the simple life and minimalism stands for sophistication and high-tech comfort.

TENSION

In physics, the term tension describes the force inside an elastic body. A more metaphorical understanding is used in design, where the body is rarely elastic and the force in question is not of a physical nature, but manifests itself as a visual and emotional energy. Tension is created through polarization or a hierarchical structure, rendering an object more desirable and attractive in the long term.

TIMELESS

Not constrained or subject to a fashion or era. Timeless can be defined in totally different ways and can relate to events, people, or objects. In everyday usage, any long-awaited aesthetic unaffected by changes in fashion is labelled timeless (compare: Classic).

UNICUM

A unicum (from Latin "unus" = one, one single) is an object or a product which only exists once in this form. Even though the (democratic) nature of design manifests itself in reproducibility and serial production, unica today are no longer restricted solely to the art market. Instead, some design products are marketed (and priced) as limited editions of a serial design, or as unique objects (compare: AXOR Signature).

URBAN

The adjective (from Latin "urbanus" = belonging to the city, to: urbs = city) stands for the city or characterizing urban life. Individuals are described as educated or sophisticated if their social manners or appearance are urban. The term urban design describes town planning and development and includes the planning and the creation of all building measures in a city or landscape. That includes public buildings as well as residential buildings, open spaces and infrastructure. In the context of products and interior design, creations with an urban touch or character are aimed towards usefulness in the modern metropolis. Urban furniture fits perfectly into big-city-life within loft spaces and skyscrapers, and is characterized by pure elegance, without ornamentation or other representative details.

Australia – Hansgrohe Pty Ltd. / Level 1 / 123 Camberwell Rd / East Hawthorn / Victoria 3123
Tel. +61 3 9811 9971 / info@hansgrohe.com.au / axor-design.com

Belgium – Hansgrohe N.V.-S.A. / Riverside Business Park / Blvd Internationalelaan 55 K / B-1070 Anderlecht
Tel. +32 2 5430140 / Fax +32 2 5379486 / info@hansgrohe.be / axor-design.com

Croatia – Hansgrohe d.o.o. / Horvatova 82 / HR-10010 Zagreb
Tel. +385-1-56-30-800 / Fax +385-1-56-30-899 / info@hansgrohe.hr / axor-design.com

Dubai – Hansgrohe SE DMCC Branch / Swiss Tower, Cluster Y / Jumeirah Lakes Towers, Office 1904 / PO Box 34216
Tel. +971 4 448 0200 / Fax +971 4 448 0299 / sales.mea@hansgrohe.com / axor-design.com

Estonia – Hansgrohe Eesti / Mäealuse 2/1 / 12618 Tallinn
Tel. +372 6826829 / info@hansgrohe.ee / axor-design.com

Finland – Hansgrohe SE / Helsinki Branch Office / Arabiankatu 12 / FIN-00560 Helsinki
Tel. +358 (0) 207 931340 / info@hansgrohe.fi / axor-design.com

Hungary – Hansgrohe Kft. / Forgách utca 11-13 / 1139 Budapest
Tel. +36 1 2369090 / info@hansgrohe.hu / axor-design.com

India – Hansgrohe India (Pvt.) Ltd. / Office No. 701 / Lunkad Sky Station / Viman Nagar / Pune – 411014 Maharashtra / India
Phone No. +912066259500 / info@hansgrohe.in / axor-design.com

Japan – Hansgrohe Japan K.K. / Tennozu First Tower 3F / 2-2-4 Higashi Shinagawa / Shinagawa-ku / Tokyo 140-0002
Tel. +81 3 5715-3073 / Fax +81 3 5715-3088 / info@hansgrohe.co.jp / axor-design.com

Latvia – Hansgrohe Latvia / Raiņa str. 14 / LV-3913 Iecava
Tel. +371 29 229029 / info@hansgrohe.lv / axor-design.com

Lithuania – Hansgrohe atstovybė / Santosa / Ulonų g. 5 / 08240 Vilnius
Tel. +370 5 2043291 / info@hansgrohe.lt / axor-design.com

Portugal – Hansgrohe / Riera Can Pahissa, 26 / 08750 Molins de Rei
Tel. +34 93 6803900 / Fax +34 93 6803909 / info@hansgrohe.pt / axor-design.com

Singapore – Hansgrohe Pte. Ltd. / 69 Mohamed Sultan Road / Singapore 239015
Tel. +65 6884 5060 / Fax +65 6884 5071 / info@hansgrohe.com.sg / axor-design.com

South Africa – Hansgrohe South Africa (pty) Ltd. / 30 Archimedes Street / Kramerville / Johannesburg 2090
Tel. +27 11 445 0000 / Fax +27 11 445 0199 / sales@hansgrohe.co.za / axor-design.com

Sweden – Hansgrohe AB / Telefon +46 (0) 31-21 66 00 / Fax +46 (0) 31-19 01 03 / info@hansgrohe.se / axor-design.com

United Kingdom – Hansgrohe Limited / Units D1 and D2 / Sandown Park Trading Estate / Royal Mills / KT10 8BL Esher Surrey
Tel. +44 (0) 1372 472 001 / Fax +44 (0) 1372 470 670 / customerservice@hansgrohe.co.uk / axor-design.com

I M P R I N T

Publisher:
AXOR / Hansgrohe SE

Photography:
Bohmann Sjöstrand
Marco Craig
Lorenz Cugini
Alex Dwyer
Tom Hegen
Jehle & Will
Kuhnle & Knödler
Uli Maier
Markus Wendler
Mattia Zoppellaro/contrasto/laif

Photography AXOR inspiration:
Poulsen/Søren Gammelmark
Lily of the Valley - Tezenas
Designhotel Laurichhof, Pirna - Designhotel Laurichhof
Arte Surfside, Miami Beach - Kris Tamburello
The Audo, Copenhagen - Alex Dwyer
The Retreat at Blue Lagoon Island - Blue Lagoon Island
Private Apartment, Prague - Jakub Komrska
The Alchemist, Copenhagen - Claus Bech
La Réserve Eden au Lac, Zurich
Treehouse, London - Sebastian Nicholas
Banyan Tree Anji - Banyan Tree

Lithography:
Eder GmbH, Ostfildern

Typesetting:
Stolz-Krechting, Lahr

Print:
B&K Offsetdruck GmbH, Ottersweier

Date:
May 2022

All products subject to availability. Availability may be temporarily affected by material shortages, supply chain disruption or other force majeure events. Please contact us for details. Subject to change in the interest of technical advancement. Printed in Germany on 100% chlorine free bleached paper.

AXOR FINISHPLUS SURFACES

AVAILABLE IN QUANTITIES OF 1 OR MORE

Brushed Brass -950	Polished Gold Optic -990	Brushed Gold Optic -250	Brushed Bronze -140	Polished Red Gold -300	Brushed Red Gold -310
Brushed Nickel -820	Stainless Steel Optic -800	Polished Black Chrome -330	Brushed Black Chrome -340	Matt Black -670	

The lacquered Matt Black finish is only available for a selected range of AXOR products.

AVAILABLE IN QUANTITIES OF 30 OR MORE

Polished Chrome -020	Brushed Chrome -260	Polished Nickel -830	Polished Bronze -130	Polished Brass -930
-------------------------	------------------------	-------------------------	-------------------------	------------------------

AXOR TECHNOLOGIES



AIRPOWER

Enriching water with air produces plump droplets for a velvety touch on the skin.



POWDERRAIN

The finest silicone nozzles, with several openings per nozzle, provide a uniquely fine mist of water.



QUICKCLEAN

Remove limescale deposits quickly and easily with flexible silicone nozzles.



ECOSMART

Mixers and showers use up to 60-percent less water than conventional products.



SELECT

Use the Select button to switch spray modes or shower heads; switch off the water at the mixer.



COMFORTZONE

Defines the space between the wash basin and mixer. The larger the ComfortZone, the greater the variety of uses.



COOLSTART

When the handle is in the neutral position, cold water flows automatically.

AXOR SPRAY MODES



INTENSE POWDERRAIN

A powerful, concentrated shower spray invigorates the body and mind.



POWDERRAIN

Gentle droplets wrap around the body like a cocoon of water.



RAINAIR

Air-enriched water. For soft shower droplets in a full water jet.



RAIN

Lush, powerful spray with an invigorating effect. Perfect for rinsing hair.



RAINSTREAM

Voluminous beads of water. Precisely compacted into individual, parallel strands.



RAIN XL

A large-scale shower experience - surrounding the entire body.



RAIN/POWDERRAIN

Combination of powerful Rain and gently enveloping PowderRain sprays.



RAINFLOW

Powerful gush spray. Wets the body over a large area, like a waterfall.



MONORAIN

Intense, bundled spray. Pointed refreshment and relaxation.



WHIRLAIR

Concentrated water jet. Especially suited for body massages.

Perfection. Down to the last detail.
An overview of AXOR FinishPlus surfaces,
technologies and spray modes.

AXOR/Hansgrohe SE
P. O. Box 1145
77757 Schiltach
Germany
info@axor-design.com

AXOR-DESIGN.COM



