

FRAMED
Collections '24

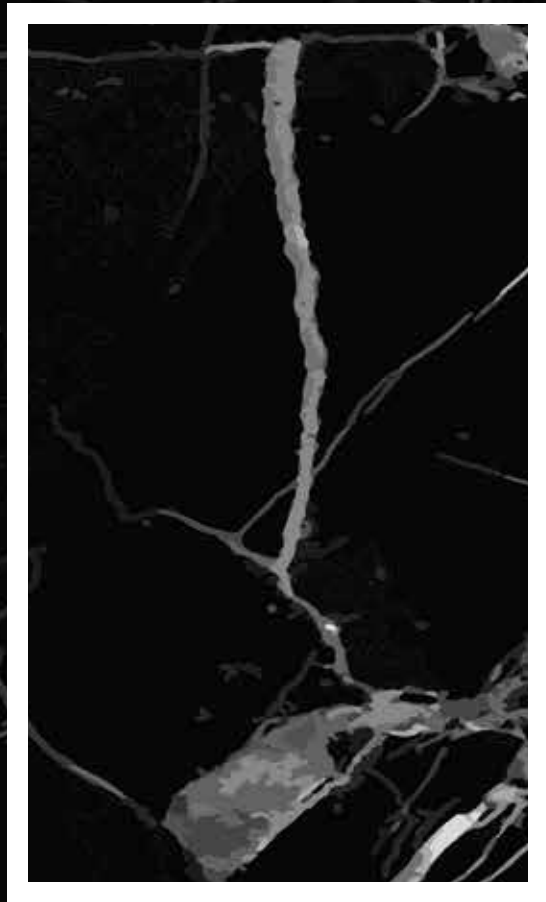

DRENCH
INSPIRE BY DESIGN

***Step into our space
that's a realm of possibilities,
where limitations take a back seat,
and imagination reigns supreme
Welcome to DRENCH***



Contents

ABOUT US	4-5
PRODUCT FEATURES	
ABOUT OUR GLASS	6-7
ABOUT OUR METALWORK	8-9
MATTE COLOURS: Classic & Pastel	10-11
BLENDING FINISHES	12-13
METALLIC FINISHES: Brushed & Polished	14
PRODUCT CONFIGURATIONS	16-17

THE COLLECTIONS '24

FRAME Lite, SUZHOU, DECO & BORDER Collections

Fixed Panels	20-23
Fixed Panels with Flipper	24-27
Free Standing Panels	28-31
Bath Screens	32-35
Shower Doors & Enclosures	36-39
Shower Door with Inline & Enclosures	40-43
Shower Door hinged to Inline & Enclosures	44-47

TOUCHES Collection

Shower Doors & Enclosures	50-51
Shower Door with Inline & Enclosures	52-53
Shower Door hinged to Inline & Enclosures	54-55

EDGE Collection

Semi-frameless Panels	56-59
-----------------------------	-------

BASE Shower Trays Collection	60-63
------------------------------------	-------

BESPOKE Service	64-65
ACCESSORIES & PARTS	66-69
MAINTENANCE & CLEANING	70-71
WARRANTY TERMS & CONDITIONS	72

DRENCH

INSPIRE BY DESIGN

Unit 5 & 6

About us

At DRENCH SHOWERS, we proudly stand as a British manufacturer, setting new standards in shower doors and enclosures. Our distinction lies in our extensive array of colours, finishes, and glass options that effortlessly align with the latest market trends.

The bathroom, once overlooked in the realm of design, has now transformed into a canvas for personal expression. Thanks to the influence of social media platforms like Instagram and Pinterest, people have begun to view their bathrooms as spaces for creative design.

At DRENCH, we don't merely follow trends; we lead the way in redefining bathroom design. Our commitment to innovation, meticulous design, and uncompromising quality manufacturing has culminated in our exceptional product range.

Whether you opt for our standard offerings or seek made-to-measure perfection, DRENCH empowers you with a myriad of choices, ensuring that your shower enclosure remains a unique masterpiece.

The possibilities and combinations are boundless, The only limitation is your imagination.

DRENCH's proprietary manufacturing technique, protected by patent GB2562114 and aptly named the 'Hygienic Decorative Bathroom Partition' under the Patents Act 1977, ensures you receive a one-of-a-kind product.

Our dedication to excellence extends to the careful selection of top-quality raw materials, locally sourced and rigorously tested, in accordance with British Standards BS EN 14428:2015.

Our shower panels and enclosures not only meet British Standards but also comply with the EU Construction Product Directive (EU) 305/201. Testing was conducted under the scope of System 4, enabling us to self-declare conformity for UKCA.

For your peace of mind, UCK/CE Marks are prominently featured on our packaging and assembly instructions for all DRENCH products, and they are readily available for download on our website.



www.drenchshowers.co.uk/company/

Our drivers of sustained values;



Innovation

We aim for innovation on our products and processes. We pursue differentiation and creating a leap in value for both the customer and the company.



Quality

We ensure the best components and materials are used on our products to guarantee a correct performance and long durability. Meeting and exceeding all requirements, standards, and specifications is our ultimate goal.



Integrity

We say what we mean and we mean what we say. We commit to treat everyone equally and communicate openly and honestly.



Customer Service

We dedicate our efforts to uncovering and meeting customer needs, delivering excellent service and incorporating customer feedback into product design and other business decisions.



About our Glass

At DRENCH, we elevate your spaces with the finest in safety glass. Our products are crafted from toughened glass, rigorously compliant with BS EN12150-1-2015. All standard products shown in this brochure are manufactured using 8 mm Toughened Clear/Float glass as standard.

Cross Fluted, Fluted, Frosted, Grey Tinted and Bronze glass are also available with an extra surcharge.

Choose from our selection of glass options, each offering a different level of privacy. Explore our unique choices.

DRENCH products are treated with a special coating applied on the internal face of the shower to allow for easy clean.

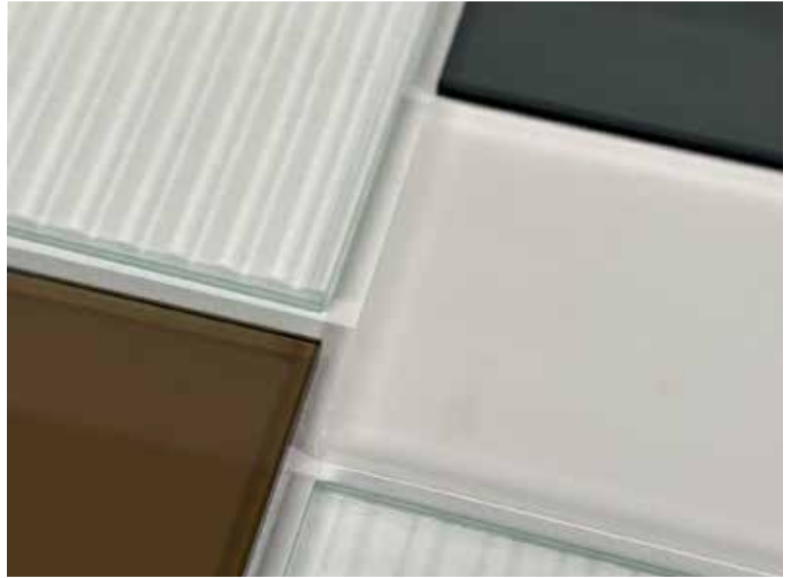

Our glass options



Clear Glass
8 mm Toughened
Float glass

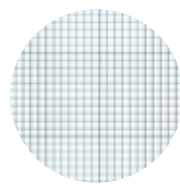

Cross Fluted
8.8 mm Toughened
Laminated



Fluted
8.8 mm Toughened
Laminated

Clear glass is always impactful as well as an elegant choice. Both 8 mm and 10 mm thicknesses are available as well as Low iron option.

Glass inside the shower area is completely smooth allowing your screen to be easily cleaned.

Impactful as well as elegant, Cross fluted is a Clear but semi-transparent glass with intersecting vertical and horizontal reeds creating a fine texture made of little concave squares.

Glass inside the shower area is completely smooth allowing your screen to be easily cleaned.

Our classic Fluted glass adds the vintage chic look and the visual interest to your Shower area. It improves the privacy by creating subtle shifting of light .

Glass inside the shower area is completely smooth allowing your screen to be easily cleaned.

*Experience a world where
transparency meets privacy*

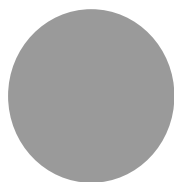

Grey Tinted
8 mm Toughened
Smoked glass

Smoked grey glass that gives a delicate look to your screen. The grey tint on the glass brings privacy and elegance. With an easy-to-clean interior, embrace both style and practicality in every detail.

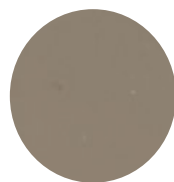

Bronze Tinted
10 mm Toughened
Smoked glass

A perfect blend of elegance and functionality. This sleek and sophisticated option, featuring a 10mm bronze-tinted glass adds a touch of warmth and privacy without sacrificing transparency. With an easy-to-clean interior, embrace both style and practicality in every detail.



Frosted
8 mm Toughened
Satin Etched

Frosted is Our most opaque glass option. External side of the glass is satin etched to create the frosted effect. The satin etch process creates a permanent decorative texture that is also scratch and fingerprint resistant. Internal side is completely smooth to be easily cleaned.

About our Metalwork

DRENCH metalwork is made of Aluminium highest grade. Aluminium is the perfect material for Shower screens as it can be extruded into complex shapes, it is mechanically strong and does not rust.

All our profiles have been specifically designed to offer a wide range of products from Wall Fixed panels, Bath Screens and the most complex range of Shower Doors and Enclosures.

DRENCH prides itself on being the originator of fully framed doors, holding a patent due to our complex and high-quality design. Unique to our fully framed collection is the option to add intricate metalwork patterns on the glass for a touch of exclusivity and privacy.

We offer a range of standard designs called 'Collections,' but our laser cutting and frame beading capabilities are limitless, allowing for endless design possibilities.

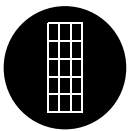

FRAME Lite



SUZHOU

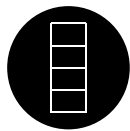

DECO

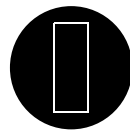

BORDER

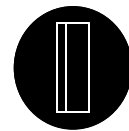

TOUCHES

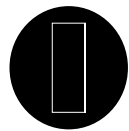

EDGE

Our finishes

At DRENCH, we're rewriting the rules of color selection. Say goodbye to the pursuit of the 'perfect match' and welcome the era of 'blending.' Blending is all about the art of mixing and combining. Why stress over the elusive perfect match when you can create a bespoke color palette and mood-board that's not only safer but also way more fun?

Enter our world of RAL Colors – available in a sophisticated 30% gloss finish, imparting a sleek matte look that's easy to combine yet endlessly elegant.

Our metalwork is no less exceptional, finished with **Architectural Powder Coating** that ensures a highly durable surface. Designed for external use, it means your shower enclosures can withstand even the busiest family bathroom while maintaining their perfect colors.



Architectural Powder Coating

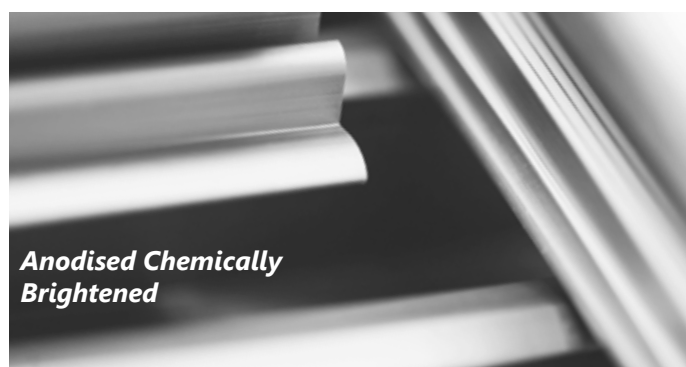

Anodised Chemically Brightened

In a world where the allure of shiny and polished finishes from the eighties still captivates, our brushed metallic colour range emerges as the perfect accent for any bathroom design.

Our metallic finishes are no ordinary fare – they're the result of a meticulous process known as anodising aluminium. **Anodising** is an electrolytic marvel that bestows an oxide film upon aluminium, enhancing its innate corrosion resistance and safeguarding those enchanting brushed, polished, etched, or brightened surfaces.



DRENCH fully framed collections - **FRAME Lite, SUZHOU, DECO, BORDER & TOUCHES** - are where stability and style converge. The metal frame wraps around the entire door, top, bottom, and sides, allowing room for creative metal finishes that harmonize with your bathroom's decor, from tiles to brassware.

Sleek and sophisticated, our semi-frameless collection **EDGE** offer a streamlined look with profiles only on the sides, leaving the top and bottom glass bare.

*Enter our world of colours and finishes
and make your bathroom
a canvas of creativity*



MATTE Colours

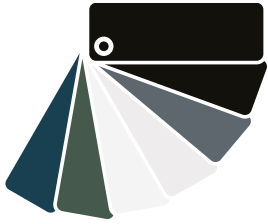

MATTE Classic

Crafted with architectural powder coating boasting a 30% gloss, these finishes epitomize sophistication and versatility.

Our Classic colors, included in the basic price of the product, draw inspiration from neutral bathroom trends, featuring shades of black, greys, white, and traditional hues like Forest green and grey navy. Rooted in our extensive experience, these classic colors exude timeless charm and command respect, making them a perfect choice for elevating any bathroom design.



Matt Black
RAL 9005

(BK)

*The standard of our bold design.
Black means power & control.
Sophistication & Elegance*



Graphite Grey
RAL 7024

(GG)

*Industrial grey with blue shades,
commonly known as Anthracite.
Solid, Stable & Neutral.*



Blanc
RAL 9002

(BL)

*Offering a sense of peace and calm,
this off white is purity,
innocence and completion.*



Total White
RAL 9003

(TT)

*Similar to its ability to reflect the light,
a full white creates a sense of space
in any room.*



Forest
RAL 6009

(FO)

*Sensual, sensitive and warm.
It highlights quality of materials.
Comfort & Structure*



Grey Navy
RAL 5008

(GN)

*It is a deep midnight blue.
Sincerity, Intuition and the
higher mind colour.*

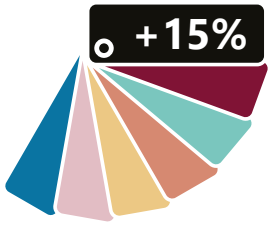

MATTE Pastel

Utilising the same architectural powder coating finish, these colors offer a daring departure from the ordinary, presenting a spectrum of risky and unusual hues.

Available for an additional 15% on top of the basic price, includes captivating shades designed for bold contrasts and seamless blending within your chosen color palette.

These Pastel colors inject personality and creativity into any bathroom space, whether harmonizing with existing tiles or furniture selections.



Rioja Red
RAL 3005

(RR)

*The standard of our bold design.
Black means power & control.
Sophistication & Elegance*



Turquoise
RAL 6034

(TQ)

*Calm and serene.
It is the perfect colour for those looking
for emotional balance in their lives.*



Burnt Orange
RAL 3022

(BO)

*It's a refreshing twist.
Use this bright and bold colour as
an accent to play it safe.*



Lemon Yellow
RAL 1012

(LY)

*Yellow is uplifting and
illuminating, offering hope,
happiness and fun..*



Pale Pink
RAL 3015

(PP)

*Pink is intuitive and insightful,
showing tenderness and kindness
with its empathy and sensitivity.*



Capri Blue
RAL 5019

(CB)

*Mediterranean blue that creates a
wonderfully tranquil space,
heavenly ideal for bathrooms.*

Blending Finishes

In a world bursting with colors, bathroom design has evolved into an exhilarating challenge for interior designers and specifiers. The endless array of finishes and hues in the market presents a delightful conundrum.

At DRENCH, we're rewriting the rules of color selection. Say goodbye to the pursuit of the 'perfect match' and welcome the era of 'blending.'

Blending is all about the art of mixing and combining. Why stress over the elusive perfect match when you can create a bespoke color palette and moodboard that's not only safer but also way more fun?

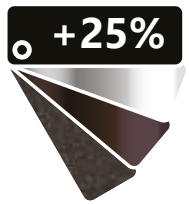
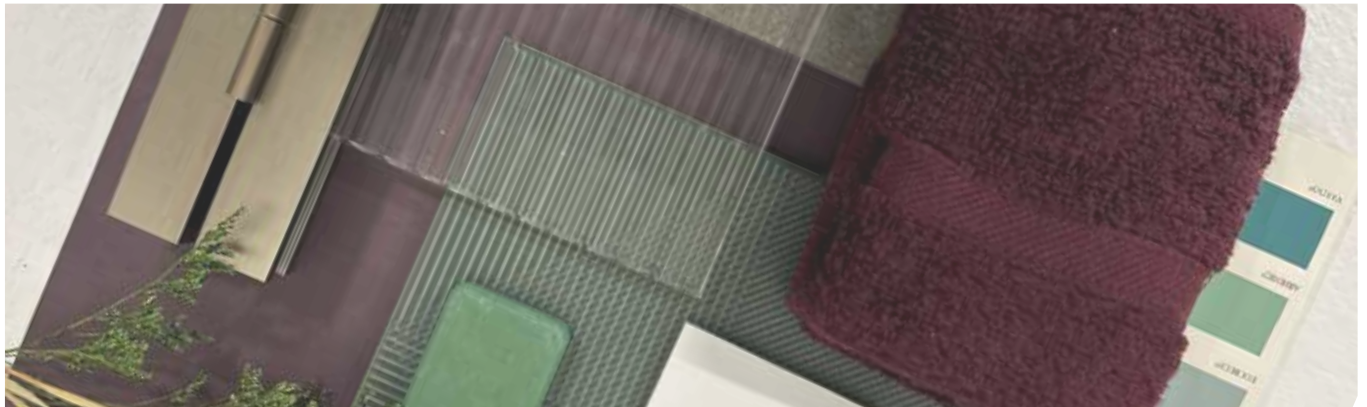

Blending Finishes

We believe gun metal and bronze metallic finishes are the most popular finishes for this 2024. We have always been especially keen on chrome finishes to return to our design roots and acknowledge their timeless appeal.

In addition to our glass options, we are excited to introduce three new blending finishes: Anodised Gun Metal, Chrome and Antique Bronze. These finishes offer versatility and sophistication, perfect for creating bespoke color palettes and moodboards.



Gun Metal
Anodised

(GM)

Elegant dark gray with a bronze tinge ideal for contrasting colours and bold designs.

****Available from July 2024****



Chrome
Anodised

(CH)

Polished silver anodised that has a lovely mirrored finish making your shower to stand out.



Antique Bronze
Textured PCoating

(NZ)

Bronze textured finish that brings heritage as well as elegance. It works both to bring neutrality and contrast.



*Dare to dream in color.
Let your imagination run wild with our
colours and finishes,
where every shade tells a story.*

Metallic Finishes

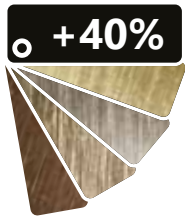

Metallic Brushed

As the allure of shiny and polished finishes from the eighties continues to captivate, our brushed metallic color range emerges as the perfect accent for modern bathroom designs. Crafted to perfection, our Brushed finishes exude understated elegance and timeless appeal.

Each finish boasts a distinctive texture and subtle luster, adding depth and character to any bathroom space. Elevate your design with these sophisticated metallic hues, creating a luxurious ambiance that stands the test of time.



Brushed Brass
Anodised

(BB)

Elegant, timeless and luxurious yellow-coloured finish.



Brushed Steel
Anodised

(BS)

Driven by industrial chic trend, an impactful yet elegant steel look.



Light Bronze
Anodised

(LB)

Bronze finish in between copper and brass.



Dark Bronze
Anodised

(DB)

Evoking oil rubbed bronze finish, warm and sophisticated.



*Elevate your space
with the subtle sophistication
of our Metallic Finishes*



Metallic Polished

With a nod to traditional bathroom designs, our Polished Brass and Nickel finishes embody timeless elegance and sophistication.

Gleaming with unparalleled radiance, these finishes exude luxury and refinement, transforming any space into a sanctuary of indulgence. Experience the epitome of quality craftsmanship and exquisite design with our Metallic Polished Finishes, where every detail reflects a commitment to excellence and enduring beauty.



Polished Brass
Anodised

(PB)

*What is luxury without
some polished brass involved?*



Polished Nickel
Anodised

(PN)

*Traditionally elegant and timeless.
It is just the accent you need.*

Product Configurations

DRENCH offers a diverse range of standard configurations for your shower area, meticulously designed to meet your needs.

From Wall Fixed Panels to intricate Shower Enclosures, our products adhere to industry-standard dimensions for seamless integration with baths, shower trays, and wetrooms.

Each configuration features our signature glass options and finishes, ensuring both style and functionality.

While our Collections may not be available for every configuration, our detailed drawings and descriptions will guide you through our product range.

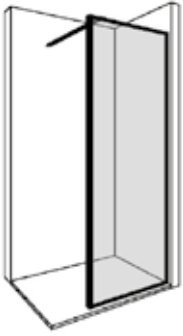

Wall Fixed Panels

Wall Fixed Panels offer a sleek and versatile solution for your shower area. These panels are attached to the wall using our wall channels and support bar system, ensuring stability and durability. With reversible design options, they can be installed on either left or right-hand walls, except for the SUZHOU collection, which are handed due to their unique metalwork design.

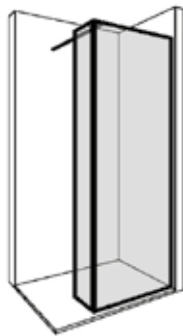

Wall Fixed Panels with Flipper panel

Enhance your shower space with DRENCH's Wall Fixed Panels featuring Flipper Panels. The flipper panel is securely attached to the wall fixed panel using our pivot system, allowing for adjustable swinging from 0 to 180 degrees. Enjoy flexibility and convenience in your shower experience with this innovative design.

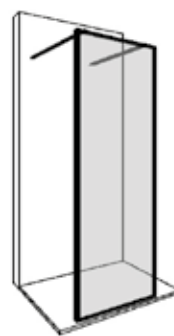

Free Standing panels

Experience freedom and versatility with DRENCH's Free Standing Panels. These panels sit atop wetrooms or shower trays and are anchored to the wall with two support bars, creating a spacious entryway for your shower area. Enjoy the ease of installation and the open design for a seamless shower experience.

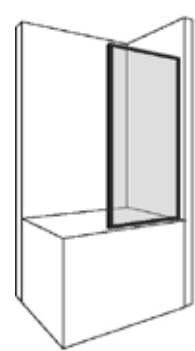

Bath Screens

DRENCH offers Bath Screens in both Fixed and Pivot versions for bath installations. Our Fixed Bath Screens are a compact version of our Wall Fixed Panels, ideal for baths. Additionally, our Pivot Bath Screens feature a 180-degree swinging hinge, enhancing accessibility and functionality in your bath space.

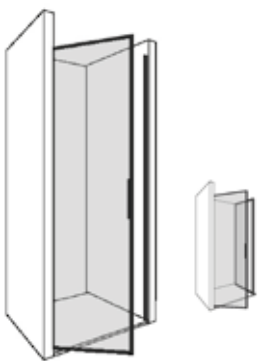

Shower Doors & Enclosures

Discover the sophistication and durability of DRENCH Shower Doors & Enclosures. Our robust designs feature Right or Left-hand hinges, with the handing determined by the hinge position when viewed from the outside.

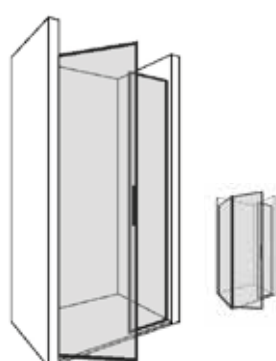

Doors with inline & Enclosures

These doors are hinged to the wall/return panel, closing into the Inline panel. Choose between Right or Left-hand hinges, identified by the hinge position when viewed from the outside.

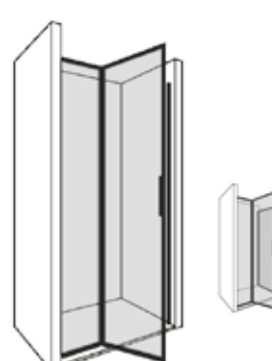

Doors hinged to inline & Enclosures



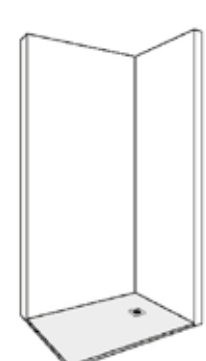







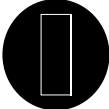
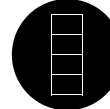
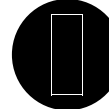
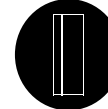



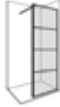

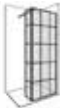
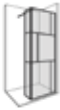

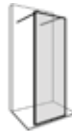

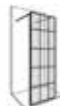

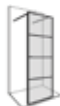

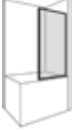











These doors are hinged to the wall/return panel, closing into the Inline panel, closing into the wall/return panel. Select Right or Left-hand hinges, distinguished by the hinge position when viewed from the outside.



Shower Trays

Slate Textured Shower Trays by DRENCH. Designed to complement our Shower Panels and Enclosures, these trays offer four colour options and various grating styles, inspiring creativity in your bathroom design.

Product Configurations vs Collections

						
	EDGE	FRAME Lite	SUZHOU	DECO	BORDER	TOUCHES
 Wall Fixed Panels						×
 Wall Fixed Panels with Flipper panel	×					×
 Free Standing panels						×
 Bath Screens	×					×
 Shower Doors & Enclosures	×					
 Doors with inline & Enclosures	×					
 Doors hinged to inline & Enclosures	×					

THE COLLECTIONS '24

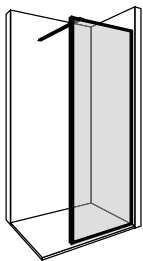

Wall Fixed Panels

Features & Pricelist

Pages:
20 - 23

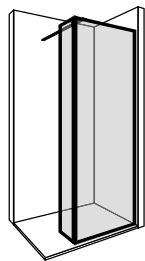

Fixed Panels with Flipper

Features & Pricelist

Pages:
24 - 27

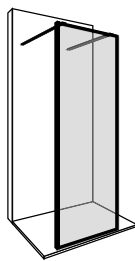

Free Standing Panels

Features & Pricelist

Pages:
28 - 31

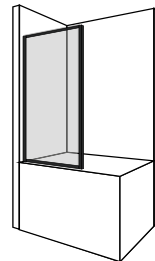

Bath Screens

Features & Pricelist

Pages:
32 - 35

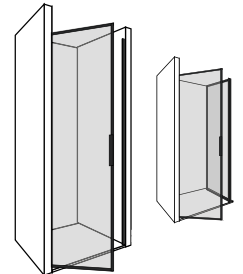

Shower Doors & Enclosures

Features & Pricelist

Pages:
36 - 39



FRAME Lite

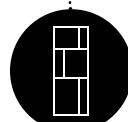

SUZHOU

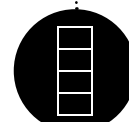

DECO

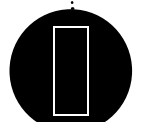

BORDER

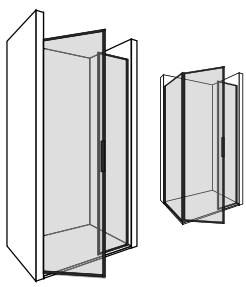
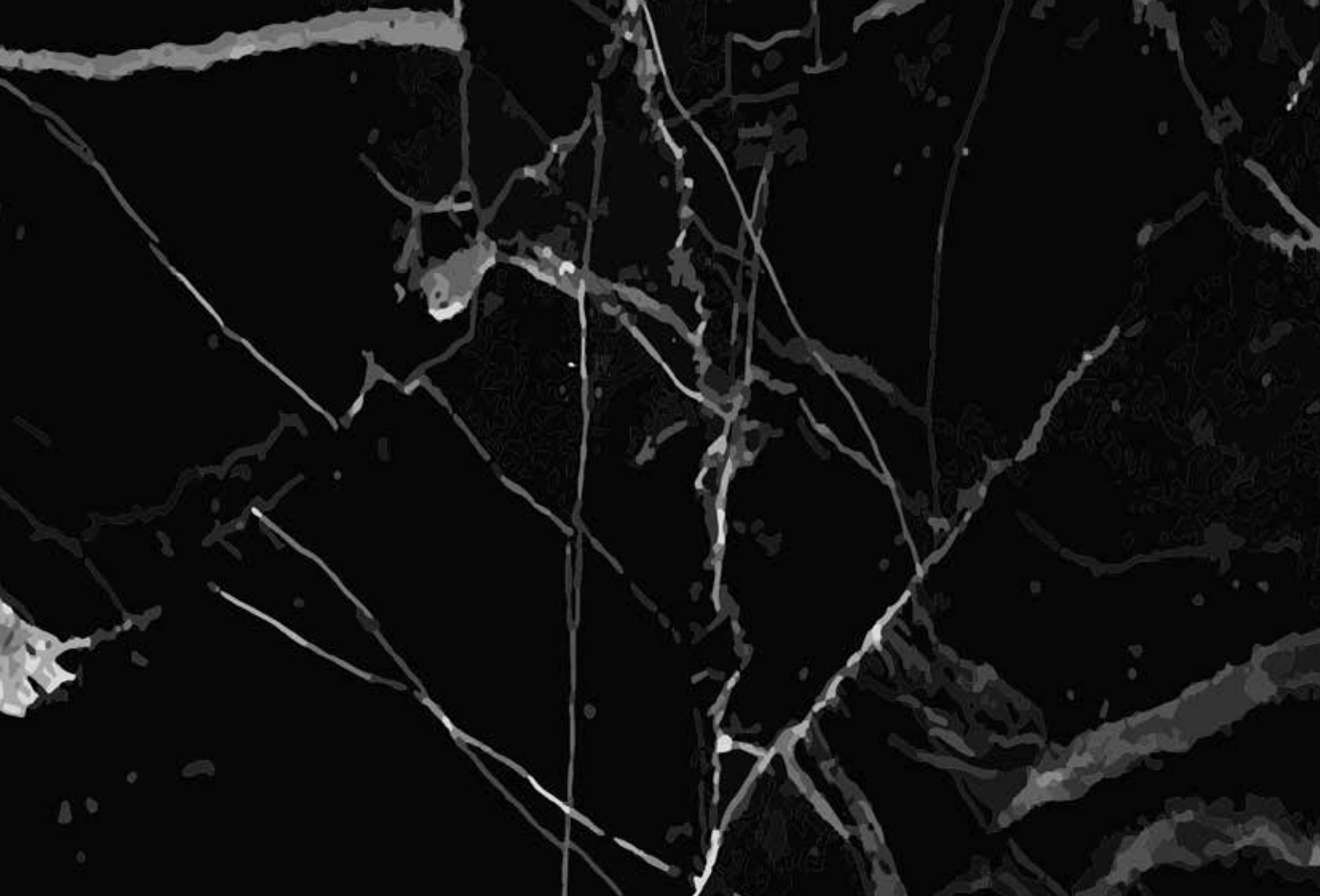

**Door with Inline
& Enclosures**

*Features
& Pricelist*

Pages:
40 - 43

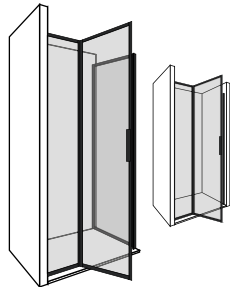

**Door hinged to
Inline & Enclosures**

*Features
& Pricelist*

Pages:
44 - 47

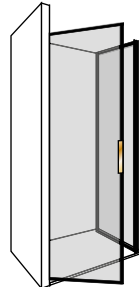

**TOUCHES
Collection**

*Doors
Door with Inline
Door hinged to Inline*

Pages:
48 - 55

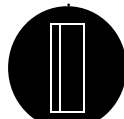

TOUCHES

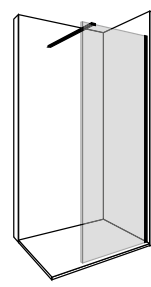

**EDGE
Collection**

*Wall Fixed Panels
Free Standing Panels*

Pages:
56 - 59

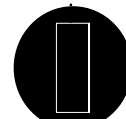

EDGE

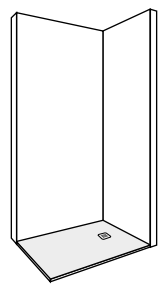

**BASE
Collection**

*Shower Trays
& Accessories*

Pages:
60 - 63

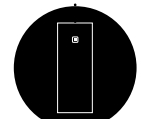

BASE

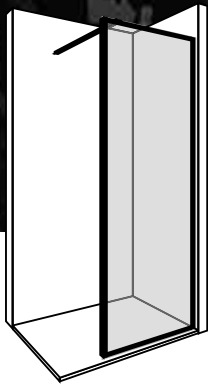

Wall Fixed Panels

DRENCH's Wall Fixed Panels offer a sleek and versatile solution for your shower area.

These panels are attached to the wall using our **wall channels and support bar system**, ensuring stability and durability. Across support bar is included on the fixed panel box as standard. Other support bar options are available.

Our Fixed panels are designed to fit both Shower tray and Wet room configurations, please note Adjustment range for your desired dimension. With **reversible** design options, they can be installed on either left or right-hand walls, except for the SUZHOU collection, which are handed due to their unique metalwork design.



Wall Channel
Adjustment 19 mm
(+/-9.5 mm)



FXSBCRS
Across Support Bar
(1000 mm)

Glass Options available:

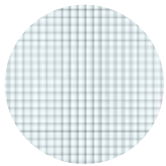

Crossed Fluted
8,8 mm Laminated



Fluted
8,8 mm Laminated

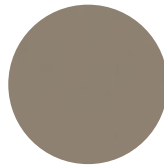

Bronze Tinted
10 mm Toughened

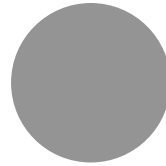

Grey Tinted
8 mm Toughened



Frosted
8 mm Satin Etch



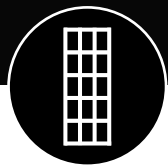

FRAME Lite



SUZHOU



DECO



BORDER



RH



LH



Combinations: Walk-In Showers

DRENCH Shower panels can be used individually or combined to recreate a walk-in shower space.

When Shower panels are ordered individually support bars required for installation are included in the price and supplied by DRENCH. When Shower Panels are combined, possibilities are endless hence we have designed a range of accessories suitable for any design or configuration. Please Check Support bar specifications on pricing pages.

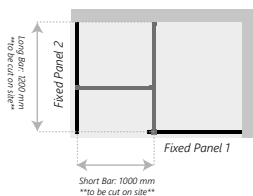
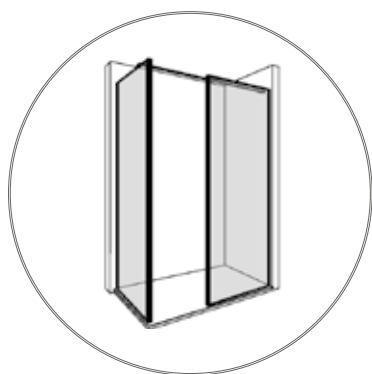

For Walk-In showers with Wall Fixed panels, **T Shape support bar (FXSBT-BAR..)** is recommended for installation purposes.

Please note the T BAR includes 2 bars at 1200 and 1000 mm.

These bars can be trimmed on site to fit most of standard walk in shower dimensions.

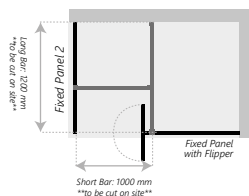
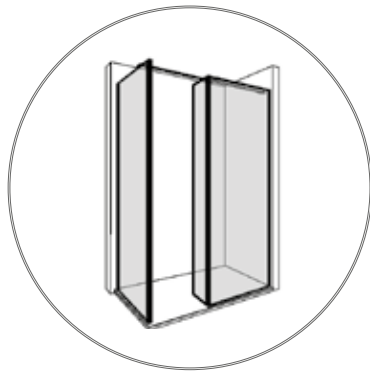

For Walk-In showers with Wall Fixed panels and Fixed Panel with Flipper, **T Shape support bar (FXSBT BAR..)** is recommended for installation purposes.

Please note the T BAR includes 2 bars at 1200 and 1000 mm.

These bars can be trimmed on site to fit most of standard walk in shower dimensions.

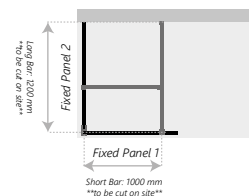
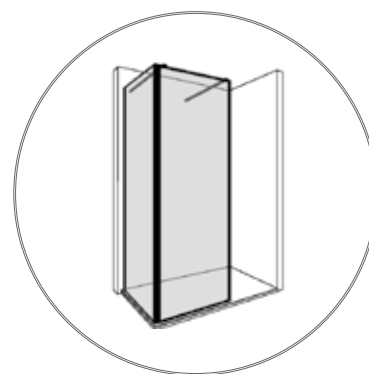

For L-Shape configurations with Wall Fixed panels, **Corner channel (PR758)** and extra **T Shape support bar (FXSBT BAR..)** is recommended for installation purposes.

Please note the T BAR includes 2 bars at 1200 and 1000 mm.

These bars can be trimmed on site to fit most of standard walk in shower dimensions.

Wall Fixed Panels

Steps to order:

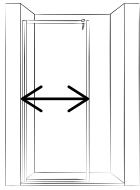

1. Choose your dimension required and if Clear Glass or Glass option needed.

2. Choose your collection; **FRAME Lite, SUZHOU, DECO or BORDER**



3. Choose your glass option and select the applicable price.

Item Code	Basic Price
FXCOLWW..	£Clear Glass
	£Glass Option



4. Choose your Colour/Finish option, add the two letter code and apply relevant %.

5. Add the 3 digits code Glass option when applicable

Example: *FXBOR100BK-FLU*

All codes below include the product as well as all items required for installation. Please check adjustment range as well as components section below to guarantee a correct fit.



FRAME Lite



SUZHOU



DECO

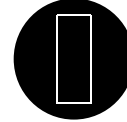

BORDER

Product Description & Dimensions	Basic Price		Basic Price		Basic Price		Basic Price	
	Item Code	£Clear Glass	Item Code (L Left/ R Right hand version)	£Clear Glass	Item Code	£Clear Glass	Item Code	£Clear Glass
		£Glass option		£Glass option		£Glass option		£Glass option
Fixed Panel 300 mm x 2100 mm	FXLTE30..	£732	FXSUZ30L.. FXSUZ30R..	£727	FXDEC30..	£642	FXBOR30..	£627
		£988		£981		£867		£846
Fixed Panel 400 mm x 2100 mm	FXLTE40..	£790	FXSUZ40L.. FXSUZ40R..	£763	FXDEC40..	£685	FXBOR40..	£663
		£1,067		£1,030		£925		£895
Fixed Panel 500 mm x 2100 mm	FXLTE50..	£849	FXSUZ50L.. FXSUZ50R..	£844	FXDEC50..	£728	FXBOR50..	£706
		£1,146		£1,139		£983		£953
Fixed Panel 600 mm x 2100 mm	FXLTE60..	£933	FXSUZ60L.. FXSUZ60R..	£933	FXDEC60..	£773	FXBOR60..	£743
		£1,260		£1,260		£1,044		£1,003
Fixed Panel 700 mm x 2100 mm	FXLTE70..	£1,150	FXSUZ70L.. FXSUZ70R..	£1,030	FXDEC70..	£816	FXBOR70..	£796
		£1,553		£1,391		£1,102		£1,075
Fixed Panel 800 mm x 2100 mm	FXLTE80..	£1,382	FXSUZ80L.. FXSUZ80R..	£1,108	FXDEC80..	£1,079	FXBOR80..	£941
		£1,866		£1,496		£1,457		£1,270
Fixed Panel 900 mm x 2100 mm	FXLTE90..	£1,431	FXSUZ90L.. FXSUZ90R..	£1,159	FXDEC90..	£1,126	FXBOR90..	£986
		£1,932		£1,565		£1,520		£1,331
Fixed Panel 1000 mm x 2100 mm	FXLTE100..	£1,543	FXSUZ100L.. FXSUZ100R..	£1,223	FXDEC100..	£1,209	FXBOR100..	£1,033
		£2,083		£1,651		£1,632		£1,395
Fixed Panel 1200 mm x 2100 mm	FXLTE120..	£1,609	FXSUZ120L.. FXSUZ120R..	£1,320	FXDEC120..	£1,310	FXBOR120..	£1,126
		£2,172		£1,782		£1,769		£1,520
Fixed Panel 1400 mm x 2100 mm	FXLTE140..	£1,735	FXSUZ140L.. FXSUZ140R..	£1,495	FXDEC140..	£1,412	FXBOR140..	£1,221
		£2,342		£2,018		£1,906		£1,648

All prices shown above are Excluding VAT. For dimensions that do not fit our Standard range please contact us, we are experts on Bespoke and made to measure projects. Please email us at sales@drenchshowers.co.uk.

Components:



Wall Channel
Adjustment 19 mm
(+/-9.5 mm)



FXSBCRS
Across Support Bar
(1000 mm)

Adjustment range:

Please note DRENCH standard items are designed to fit both shower trays and wetroom installations. Please take into consideration our adjustment range as per below table.

Dimension shown (in mm)	Minimum	Mid-Point (Physical size of unit in the box)	Maximum
300	275	280	290
400	375	380	390
500	475	480	490
600	575	580	590
700	675	680	690
800	775	780	790
900	875	880	890
1000	975	980	990
1200	1175	1180	1190
1400	1375	1380	1390

Support Bars for Walk-In Shower combinations:

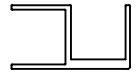
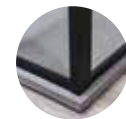
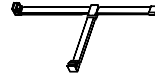
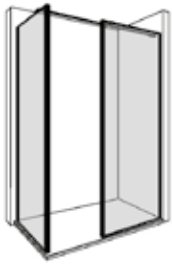

Item Code	Basic Price Exc VAT	Item Code	Basic Price Exc VAT	Item Code	Basic Price Exc VAT
FXSBNGL...	£106	FXSTBAR..	£172	PR758..	£137

90° Angle Support Bar
(3 components, not pre-assembled)
450 mm length, 30 x 10 mm bar.

****Not suitable for panels wider than 1000 mm****

T-Shape Support bar
(4 components, not pre-assembled)
2x 30 x 10 mm bars.

Long bar 1200 mm + Short bar at 1000 mm
****Suitable for Shower Panels combinations****

Corner Channel
for L Shape configurations

Wall Fixings included.
2100 mm standard length

Metalwork Colours & Finishes

Choose your colour/finish add the two letter code to your main product code and apply the relevant % to the Basic price.

MATTE Classic



Basic Price
Matt Black RAL 9005 BK
Graphite Grey RAL 7024 GG
Blanc RAL 9002 BL
Total White RAL 9003 TT
Forest RAL 6009 FO
Grey Navy RAL 5008 GN

MATTE Pastel

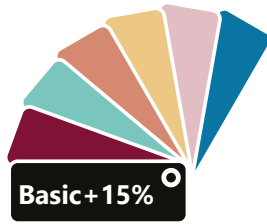

Basic+15%
Rioja Red RAL 3005 RR
Turquoise RAL 6034 TQ
Burnt Orange RAL 3022 BO
Lemon Yellow RAL 1012 LY
Pale Pink RAL 3015 PP
Capri Blue RAL 5019 CB

Metallic Brushed



Basic+40%
Brushed Brass Anodised BB
Brushed Steel Anodised BS
Light Bronze Anodised LB
Dark Bronze Anodised DB

Blending Finishes



Basic+25%
Chrome Anodised CH
Gun Metal Anodised GM <small>**available from July 2024**</small>
Antique Bronze Textured Powder Coating NZ

Metallic Polished



Basic+50%
Polished Brass Anodised PB
Polished Nickel Anodised PN

Glass Options

Choose your glass option add the three letter code to your order after **selecting your Glass Option price applicable.**

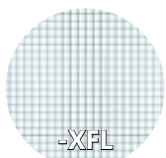

Crossed Fluted
8,8 mm Laminated



Fluted
8,8 mm Laminated



Bronze Tinted
10 mm Toughened



Grey Tinted
8 mm Toughened



Frosted
8 mm Satin Etch

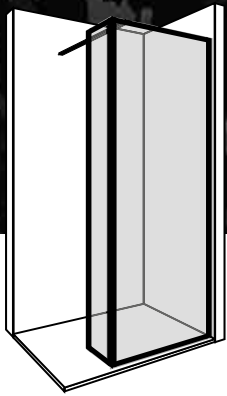

Wall Fixed Panels with Flipper panel

Enhance your shower space with DRENCH's Wall Fixed Panels featuring Flipper Panels.

The flipper panel is securely attached to the wall fixed panel using our pivot system, allowing for adjustable swinging from 0 to 180 degrees.

Flipper panel cannot be installed retrospectively. This item is handed so Right or Left hand version must be specified when ordering.



Wall Channel
Adjustment 19 mm
(+/-9.5 mm)



FXSBCRS
Across Support Bar
(1000 mm)



PIVOT Hinge
Flipper Panel
0 to 90 degree position.

Glass Options available:

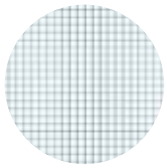

Crossed Fluted
8,8 mm Laminated



Fluted
8,8 mm Laminated

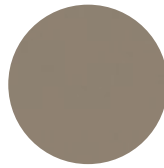

Bronze Tinted
10 mm Toughened

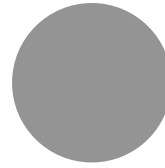

Grey Tinted
8 mm Toughened



Frosted
8 mm Satin Etch



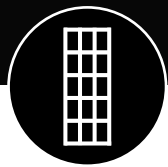

FRAME Lite



SUZHOU



DECO



BORDER



*all illustrations above show RH versions.

Combinations: Walk-In Showers

DRENCH Shower panels can be used individually or combined to recreate a walk-in shower space.

When Shower panels are ordered individually support bars required for installation are included in the price and supplied by DRENCH. When Shower Panels are combined, possibilities are endless hence we have designed a range of accessories suitable for any design or configuration. Please Check Support bar specifications on pricing pages.

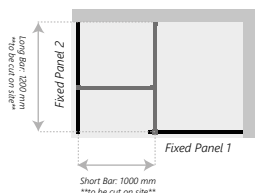
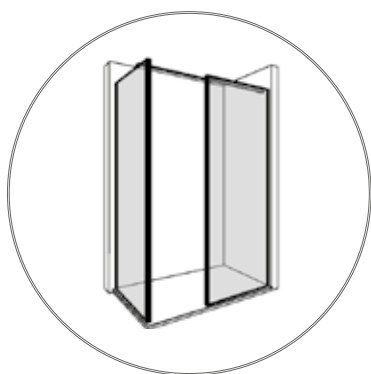

For Walk-In showers with Wall Fixed panels, **T Shape support bar (FXSBT-BAR..)** is recommended for installation purposes.

Please note the TBAR includes 2 bars at 1200 and 1000 mm.

These bars can be trimmed on site to fit most of standard walk in shower dimensions.

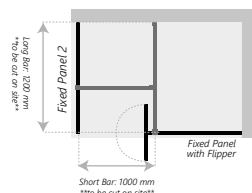

For Walk-In showers with Wall Fixed panels and Fixed Panel with Flipper, **T Shape support bar (FXSBT-BAR..)** is recommended for installation purposes.

Please note the TBAR includes 2 bars at 1200 and 1000 mm.

These bars can be trimmed on site to fit most of standard walk in shower dimensions.

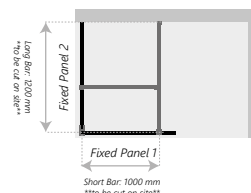
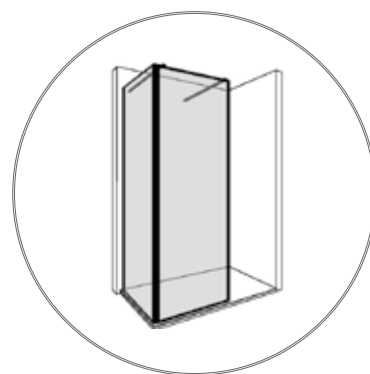

For L-Shape configurations with Wall Fixed panels, **Corner channel (PR758)** and extra **T Shape support bar (FXSBT-BAR..)** is recommended for installation purposes.

Please note the TBAR includes 2 bars at 1200 and 1000 mm.

These bars can be trimmed on site to fit most of standard walk in shower dimensions.

Wall Fixed Panels with Flipper panel

Steps to order:

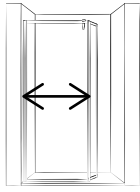

1. Choose your dimension required and if Clear Glass or Glass option needed.

2. Choose your collection; FRAME Lite, SUZHOU, DECO or BORDER



3. Choose your glass option and select the applicable price.

Item Code	Basic Price
FXCOLWWFLIPL.. FXCOLWWFLIPR..	£Clear Glass
	£Glass Option



4. Choose your Colour/Finish option, add the two letter code and apply relevant %.

5. Add the 3 digits code Glass option when applicable

Example:
FXBOR90FLIPLBK-FLU

Please note Flipper panels are handed.
Flipper panel cannot be fitted retrospectively.

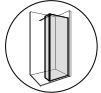

RH

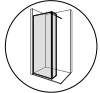

LH



FRAME Lite



SUZHOU

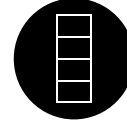

DECO

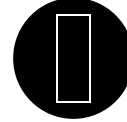

BORDER

Product Description & Dimensions	Item Code (L Left/ R Right hand version)	Basic Price		Item Code (L Left/ R Right hand version)	Basic Price		Item Code (L Left/ R Right hand version)	Basic Price		Item Code (L Left/ R Right hand version)	Basic Price	
		£Clear Glass			£Clear Glass			£Clear Glass			£Clear Glass	
		£Glass option			£Glass option			£Glass option			£Glass option	
Fixed Panel 300 x 2100 mm with 300 Flipper	FXLTE30FLIPL..	£1,141		FXSUZ30FLIPL..	£997		FXDEC30FLIPL..	£983		FXBOR30FLIPL..	£964	
	FXLTE30FLIPR..	£1,540		FXSUZ30FLIPR..	£1,346		FXDEC30FLIPR..	£1,327		FXBOR30FLIPR..	£1,301	
Fixed Panel 400 x 2100 mm with 300 Flipper	FXLTE40FLIPL..	£1,197		FXSUZ40FLIPL..	£1,049		FXDEC40FLIPL..	£1,008		FXBOR40FLIPL..	£1,005	
	FXLTE40FLIPR..	£1,616		FXSUZ40FLIPR..	£1,416		FXDEC40FLIPR..	£1,361		FXBOR40FLIPR..	£1,357	
Fixed Panel 500 x 2100 mm with 300 Flipper	FXLTE50FLIPL..	£1,257		FXSUZ50FLIPL..	£1,076		FXDEC50FLIPL..	£1,064		FXBOR50FLIPL..	£1,031	
	FXLTE50FLIPR..	£1,697		FXSUZ50FLIPR..	£1,453		FXDEC50FLIPR..	£1,436		FXBOR50FLIPR..	£1,392	
Fixed Panel 600 x 2100 mm with 300 Flipper	FXLTE60FLIPL..	£1,315		FXSUZ60FLIPL..	£1,093		FXDEC60FLIPL..	£1,111		FXBOR60FLIPL..	£1,087	
	FXLTE60FLIPR..	£1,775		FXSUZ60FLIPR..	£1,476		FXDEC60FLIPR..	£1,500		FXBOR60FLIPR..	£1,467	
Fixed Panel 700 x 2100 mm with 300 Flipper	FXLTE70FLIPL..	£1,373		FXSUZ70FLIPL..	£1,157		FXDEC70FLIPL..	£1,143		FXBOR70FLIPL..	£1,128	
	FXLTE70FLIPR..	£1,854		FXSUZ70FLIPR..	£1,562		FXDEC70FLIPR..	£1,543		FXBOR70FLIPR..	£1,523	
Fixed Panel 800 x 2100 mm with 300 Flipper	FXLTE80FLIPL..	£1,720		FXSUZ80FLIPL..	£1,401		FXDEC80FLIPL..	£1,278		FXBOR80FLIPL..	£1,181	
	FXLTE80FLIPR..	£2,322		FXSUZ80FLIPR..	£1,891		FXDEC80FLIPR..	£1,725		FXBOR80FLIPR..	£1,594	
Fixed Panel 900 x 2100 mm with 300 Flipper	FXLTE90FLIPL..	£1,778		FXSUZ90FLIPL..	£1,444		FXDEC90FLIPL..	£1,318		FXBOR90FLIPL..	£1,226	
	FXLTE90FLIPR..	£2,400		FXSUZ90FLIPR..	£1,949		FXDEC90FLIPR..	£1,779		FXBOR90FLIPR..	£1,655	
Fixed Panel 1000 mm x 2100 mm with 300 Flipper	FXLTE100FLIPL..	£1,812		FXSUZ100FLIPL..	£1,477		FXDEC100FLIPL..	£1,364		FXBOR100FLIPL..	£1,255	
	FXLTE100FLIPR..	£2,446		FXSUZ100FLIPR..	£1,994		FXDEC100FLIPR..	£1,841		FXBOR100FLIPR..	£1,694	
Fixed Panel 1200 mm x 2100 mm with 300 Flipper	FXLTE120FLIPL..	£1,925		FXSUZ120FLIPL..	£1,574		FXDEC120FLIPL..	£1,451		FXBOR120FLIPL..	£1,342	
	FXLTE120FLIPR..	£2,599		FXSUZ120FLIPR..	£2,125		FXDEC120FLIPR..	£1,959		FXBOR120FLIPR..	£1,812	
Fixed Panel 1400 mm x 2100 mm with 300 Flipper	FXLTE140FLIPL..	£2,020		FXSUZ140FLIPL..	£1,667		FXDEC140FLIPL..	£1,576		FXBOR140FLIPL..	£1,425	
	FXLTE140FLIPR..	£2,727		FXSUZ140FLIPR..	£2,250		FXDEC140FLIPR..	£2,128		FXBOR140FLIPR..	£1,924	

All prices shown above are Excluding VAT. For dimensions that do not fit our Standard range please contact us, we are experts on Bespoke and made to measure projects. Please email us at sales@drenchshowers.co.uk.

Components:



Wall Channel
Adjustment 19 mm
(+/-9.5 mm)



FXSBCRS
Across Support Bar
(1000 mm)



PIVOT Hinge
Flipper Panel
0 to 90 degree position.

Adjustment range:

Please note DRENCH standard items are designed to fit both shower trays and wetroom installations. Please take into consideration our adjustment range.

Dimension shown (in mm)	Minimum	Mid-Point (Physical size of unit in the box)	Maximum
300 + 300	575	580	590
400 + 300	675	680	690
500 + 300	775	780	790
600 + 300	875	880	890
700 + 300	975	980	990
800 + 300	1075	1080	1090
900 + 300	1175	1180	1190
1000 + 300	1275	1280	1290
1200 + 300	1475	1480	1490
1400 + 300	1675	1680	1690

Support Bars for Walk-In Shower combinations:

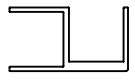
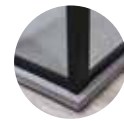
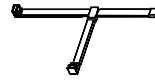

Item Code	Basic Price Exc VAT	Item Code	Basic Price Exc VAT	Item Code	Basic Price Exc VAT
FXSBNGL...	£106	FXSTBAR..	£172	PR758..	£137

90° Angle Support Bar
(3 components, not pre-assembled)
450 mm length, 30 x 10 mm bar.

Not suitable for panels wider than 1000 mm

T-Shape Support bar
(4 components, not pre-assembled)
2x 30 x 10 mm bars.
Long bar 1200 mm + Short bar at 1000 mm

Suitable for Shower Panels combinations

Corner Channel
for L Shape configurations

Wall Fixings included.
2100 mm standard length

Metalwork Colours & Finishes

Choose your colour/finish add the two letter code to your main product code and apply the relevant % to the Basic price.

MATTE Classic



Basic Price
Matt Black RAL 9005 BK
Graphite Grey RAL 7024 GG
Blanc RAL 9002 BL
Total White RAL 9003 TT
Forest RAL 6009 FO
Grey Navy RAL 5008 GN

MATTE Pastel

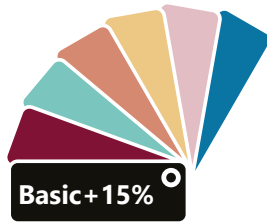

Basic+15%
Rioja Red RAL 3005 RR
Turquoise RAL 6034 TQ
Burnt Orange RAL 3022 BO
Lemon Yellow RAL 1012 LY
Pale Pink RAL 3015 PP
Capri Blue RAL 5019 CB

Metallic Brushed



Basic+40%
Brushed Brass Anodised BB
Brushed Steel Anodised BS
Light Bronze Anodised LB
Dark Bronze Anodised DB

Blending Finishes



Basic+25%
Chrome Anodised CH
Gun Metal Anodised GM <i>**available from July 2024**</i>
Antique Bronze Textured Powder Coating NZ

Metallic Polished



Basic+50%
Polished Brass Anodised PB
Polished Nickel Anodised PN

Glass Options

Choose your glass option add the three letter code to your order after **selecting your Glass Option price applicable.**

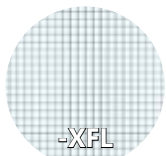

Crossed Fluted
8,8 mm Laminated



Fluted
8,8 mm Laminated



Bronze Tinted
10 mm Toughened



Grey Tinted
8 mm Toughened



Frosted
8 mm Satin Etch

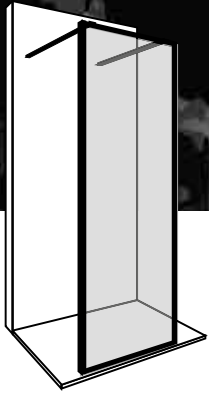

Free Standing Panels

Experience freedom and versatility with DRENCH's Free Standing Panels.

These panels sit atop wetrooms or shower trays and are anchored to the wall with two support bars, creating a spacious entryway for your shower area. Enjoy the ease of installation and the open design for a seamless shower experience.

The free standing panel includes 2 support bars across for stability purposes.



FXSBCRS
Across Support Bar
(1000 mm)

Glass Options available:

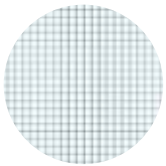

Crossed Fluted
8,8 mm Laminated



Fluted
8,8 mm Laminated

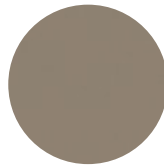

Bronze Tinted
10 mm Toughened

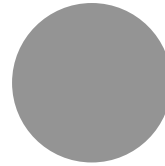

Grey Tinted
8 mm Toughened



Frosted
8 mm Satin Etch



*Discover how DRENCH transforms
your bathroom into a sanctuary
of luxury and comfort.*

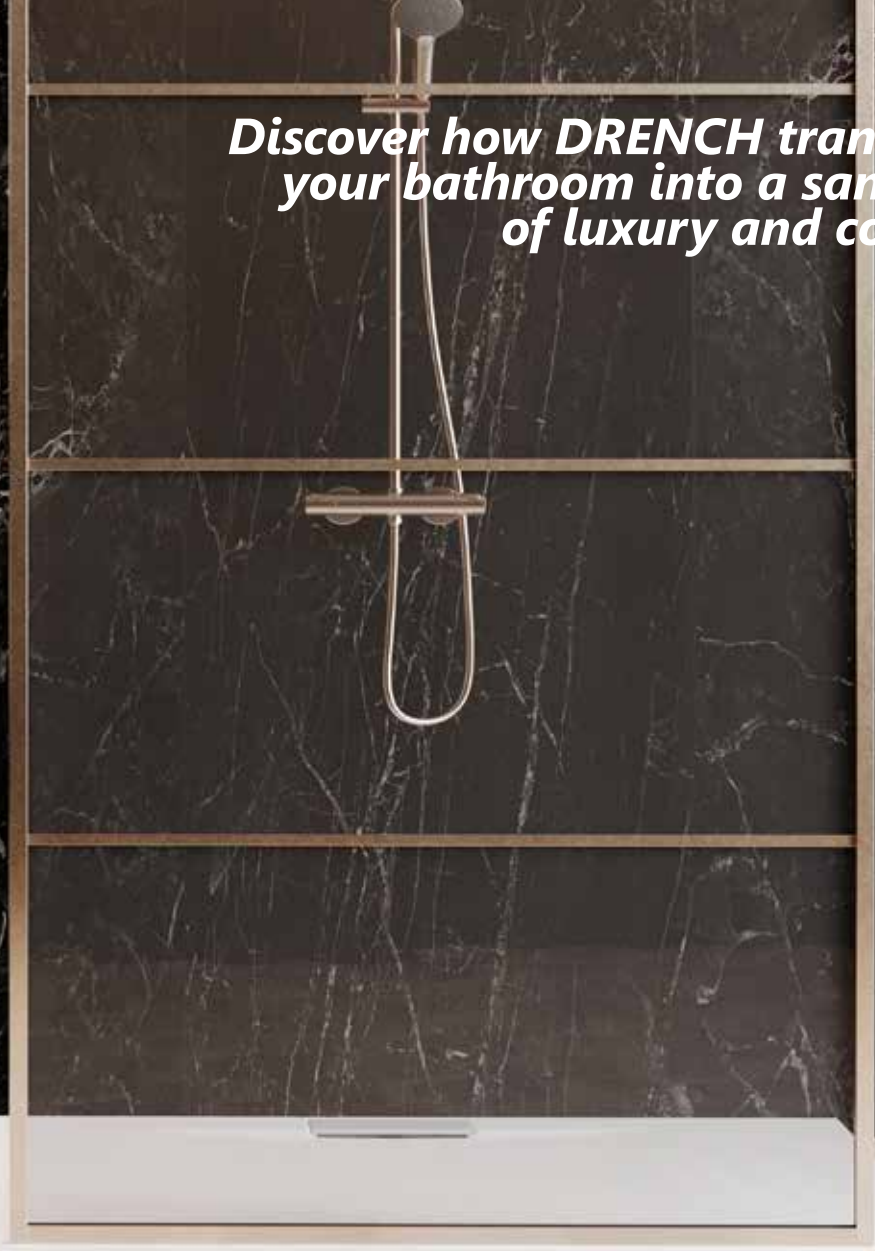

FRAME Lite



SUZHOU

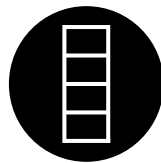

DECO

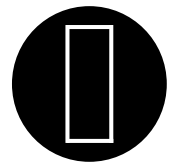

BORDER



Free Standing Panels

Steps to order:

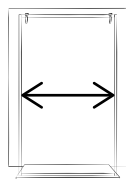

1. Choose your dimension required and if Clear Glass or Glass option needed.

2. Choose your collection; FRAME Lite, SUZHOU, DECO or BORDER



3. Choose your glass option and select the applicable price.

Item Code	Basic Price
FXCOLWWFST..	£Clear Glass
	£Glass Option



4. Choose your Colour/Finish option, add the two letter code and apply relevant %.

5. Add the 3 digits code Glass option when applicable

Example:
FXBOR120FSTBK-FLU

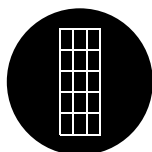
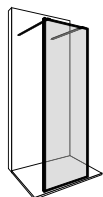

FRAME Lite

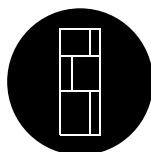

SUZHOU

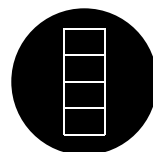

DECO

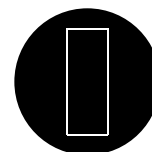

BORDER

Product Description & Dimensions	Item Code	Basic Price		Item Code	Basic Price		Item Code	Basic Price		Item Code	Basic Price	
		£Clear Glass	£Glass option		£Clear Glass	£Glass option		£Clear Glass	£Glass option		£Clear Glass	£Glass option
		Free Standing Panel 800 x 2100 mm,	FXLTE80FST..		£1,382	£1,866		FXSUZ80FST..	£1,108		£1,496	FXDEC80FST..
Free Standing Panel 900 x 2100 mm,	FXLTE90FST..	£1,431	£1,932	FXSUZ90FST..	£1,159	£1,565	FXDEC90FST..	£1,126	£1,520	FXBOR90FST..	£986	£1,331
Free Standing Panel 1000 x 2100 mm,	FXLTE100FST..	£1,543	£2,083	FXSUZ100FST..	£1,223	£1,651	FXDEC100FST..	£1,209	£1,632	FXBOR100FST..	£1,033	£1,395
Free Standing Panel 1200 x 2100 mm,	FXLTE120FST..	£1,609	£2,172	FXSUZ120FST..	£1,320	£1,782	FXDEC120FST..	£1,310	£1,769	FXBOR120FST..	£1,126	£1,520
Free Standing Panel 1400 x 2100 mm,	FXLTE140FST..	£1,735	£2,342	FXSUZ140FST..	£1,495	£2,018	FXDEC140FST..	£1,412	£1,906	FXBOR140FST..	£1,221	£1,648

All prices shown above are Excluding VAT. For dimensions that do not fit our Standard range please contact us, we are experts on Bespoke and made to measure projects. Please email us at sales@drenchshowers.co.uk.

Components:



FXSBCRS
Across Support Bar
(1000 mm)

Adjustment range:

Please note DRENCH standard items are designed to fit both shower trays and wetroom installations. Please take into consideration our adjustment range as per below table.

Free Standing panels do not have adjustment as they do not use wall channel for installation.

Dimension shown (in mm)	Minimum	Mid-Point (Physical size of unit in the box)	Maximum
800	-	762	-
900	-	862	-
1000	-	962	-
1200	-	1162	-
1400	-	1362	-

Support Bars for Walk-In Shower combinations:

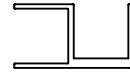
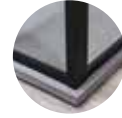
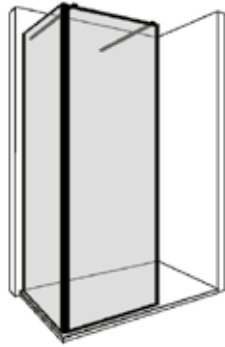

Item Code	Basic Price Exc VAT
PR758..	£137

Corner Channel for L Shape configurations

Wall Fixings included.
2100 mm standard length

Metalwork Colours & Finishes

Choose your colour/finish add the two letter code to your main product code and apply the relevant % to the Basic price.

MATTE Classic



Basic Price
Matt Black RAL 9005 BK
Graphite Grey RAL 7024 GG
Blanc RAL 9002 BL
Total White RAL 9003 TT
Forest RAL 6009 FO
Grey Navy RAL 5008 GN

MATTE Pastel

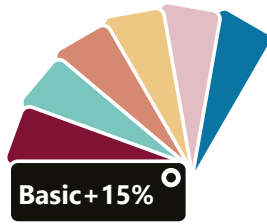

Basic+15%
Rioja Red RAL 3005 RR
Turquoise RAL 6034 TQ
Burnt Orange RAL 3022 BO
Lemon Yellow RAL 1012 LY
Pale Pink RAL 3015 PP
Capri Blue RAL 5019 CB

Metallic Brushed



Basic+40%
Brushed Brass Anodised BB
Brushed Steel Anodised BS
Light Bronze Anodised LB
Dark Bronze Anodised DB

Blending Finishes



Basic+25%
Chrome Anodised CH
Gun Metal Anodised GM <small>**available from July 2024**</small>
Antique Bronze Textured Powder Coating NZ

Metallic Polished



Basic+50%
Polished Brass Anodised PB
Polished Nickel Anodised PN

Glass Options

Choose your glass option add the three letter code to your order after **selecting your Glass Option price applicable.**

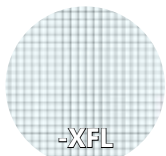

Crossed Fluted
8,8 mm Laminated



Fluted
8,8 mm Laminated



Bronze Tinted
10 mm Toughened



Grey Tinted
8 mm Toughened



Frosted
8 mm Satin Etch

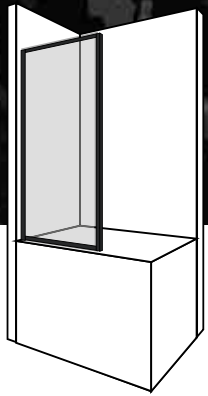

Bath Screens

There is really nothing better than a nice long soak in the tub after a long and stressful day.

Fixed Bath screen are a reduced version of our Wall fixed panels suitable to be installed onto a bath. This configuration ticks the box for small bathrooms.

Pivot Bath Screens are hinged to the wall and swing 180 degrees. Pivot bath screens are handed so make sure you choose the Left or Right hand code when ordering. There is a 10 mm gap between the bottom profile and the top of the bath to allow the pivot mechanism work. A black rubber seal is supplied with the screen to cover the gap and guarantee watertight conditions.



Fixed Bath Screen
Wall Channel Fixing



Pivot Bath Screen
180 degree swing

Glass Options available:

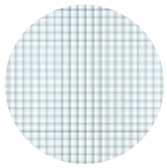

Crossed Fluted
8,8 mm Laminated



Fluted
8,8 mm Laminated



Bronze Tinted
10 mm Toughened

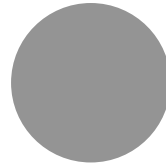

Grey Tinted
8 mm Toughened



Frosted
8 mm Satin Etch





Each configuration features our signature glass options and finishes, ensuring both style and functionality.

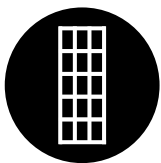

FRAME Lite



SUZHOU

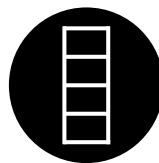

DECO

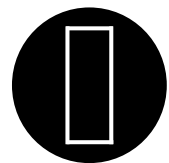

BORDER



*all illustrations above show RH versions.

Bath Screens

Steps to order:

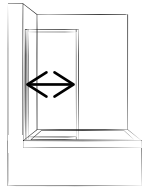

1. Choose your dimension required and if Clear Glass or Glass option needed.

2. Choose your collection; **FRAME Lite, SUZHOU, DECO or BORDER**

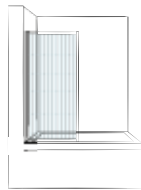

3. Choose your glass option and select the applicable price.

Item Code	Basic Price
COLFXBAT.. COLBATR/L..	£Clear Glass
	£Glass Option

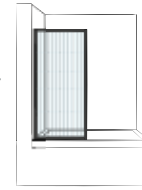

4. Choose your Colour/Finish option, add the two letter code and apply relevant %.

5. Add the 3 digits code Glass option when applicable

Example:
BORBATL BK-FRS

Please note pivot Bath screens are handed. Left (L) or Right (R) hand must be specified.

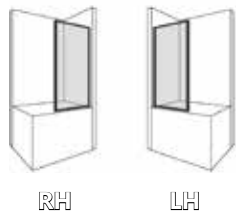

RH

LH

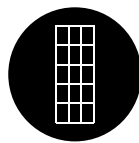

FRAME Lite

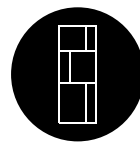

SUZHOU

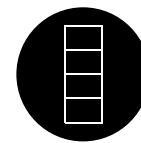

DECO

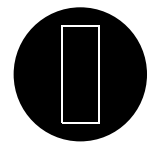

BORDER

Product Description & Dimensions	Item Code		Basic Price		Item Code		Basic Price		Item Code		Basic Price	
	(L Left/ R Right hand version)		£Clear Glass		(L Left/ R Right hand version)		£Clear Glass		(L Left/ R Right hand version)		£Clear Glass	
Fixed Bath Screen 800 mm x 1500 mm	LTFXBAT..		£795		SUZFXBAT..		£751		DECFXBAT..		£696	
			£1,073				£1,014				£940	
Pivot Hinge Bath Screen 800 mm x 1500 mm (L for Left Hand / R for Right Hand)	LTEBAT..		£878		SUZBATL..		£809		DECBATL..		£735	
	LTEBATR..		£1,185		SUZBATR..		£1,092		DECBATR..		£992	
	BORFXBAT..		£659		BORBATL..		£678		BORBATR..		£915	
			£890									

All prices shown above are Excluding VAT. For dimensions that do not fit our Standard range please contact us, we are experts on Bespoke and made to measure projects. Please email us at sales@drenchshowers.co.uk.

Components:



Wall Channel

Adjustment 19 mm
(+/-9.5 mm)



PIVOT Hinge

Flipper Panel
0 to 90 degree position.

Adjustment range:

Please note both Fixed and Pivot Bath screens are fixed to wall using our standard wall channel giving an adjustment of 19 mm (+/- 9.5 mm). Please note Pivot Bath screens are supplied with a rubber seal to guarantee watertight conditions.

Dimension shown (in mm)	Minimum	Mid-Point (Physical size of unit in the box)	Maximum
800	775	780	790

Metalwork Colours & Finishes

Choose your colour/finish add the two letter code to your main product code and apply the relevant % to the Basic price.

MATTE Classic



Matt Black
RAL 9005

BK

Graphite Grey
RAL 7024

GG

Blanc
RAL 9002

BL

Total White
RAL 9003

TT

Forest
RAL 6009

FO

Grey Navy
RAL 5008

GN

MATTE Pastel

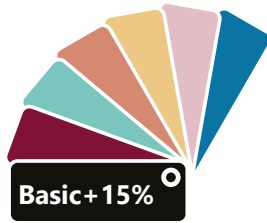

Rioja Red
RAL 3008

RR

Turquoise
RAL 6034

TQ

Burnt Orange
RAL 3022

BO

Lemon Yellow
RAL 1012

LY

Pale Pink
RAL 3015

PP

Capri Blue
RAL 5019

CB

Metallic Brushed



Brushed Brass
Anodised

BB

Brushed Steel
Anodised

BS

Light Bronze
Anodised

LB

Dark Bronze
Anodised

DB

Blending Finishes



Chrome
Anodised

CH

Gun Metal
Anodised

GM

available from July 2024

Antique Bronze
Textured Powder Coating

NZ

Metallic Polished

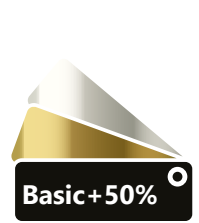

Polished Brass
Anodised

PB

Polished Nickel
Anodised

PN

Glass Options

Choose your glass option add the three letter code to your order after applying an extra 35% to the final price.

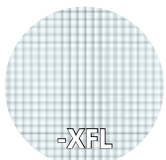

Crossed Fluted
8,8 mm Laminated



Fluted
8,8 mm Laminated



Bronze
10 mm Toughened



Grey Tinted
8 mm Toughened



Frosted
8 mm Satin Etch

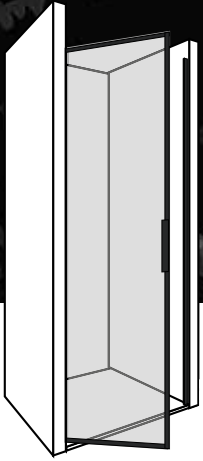

Shower Doors & Enclosures

Discover the sophistication and durability of DRENCH Shower Doors & Enclosures.

Our robust designs feature Right or Left-hand hinges, with the handing determined by the hinge position when viewed from the outside.

All DRENCH shower doors are opening OUT as standard. Feel free to contact us if opening inwards is required.

Please note doors are supplied fully assembled including handle and hinge mechanism as well as bottom seal and threshold bit to guarantee watertight installation.

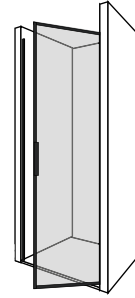

RH

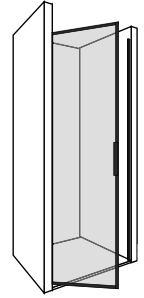

LH



Glass Options available:

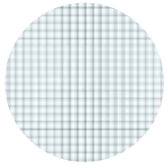

Crossed Fluted
8,8 mm Laminated



Fluted
8,8 mm Laminated

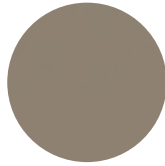

Bronze
10 mm Toughened

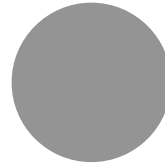

Grey Tinted
8 mm Toughened



Frosted
8 mm Satin Etch





FRAME Lite



SUZHOU



DECO



BORDER



MATTE Colours Door Features
(Architectural powder coating)

Metallic Finishes Door Features
(Anodised finishes)

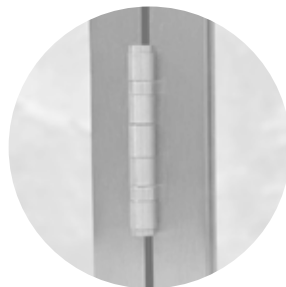

Crafted with precision, our pivot hinge mechanism features a zinc pivot casting for durability. Designed to provide a smooth swing and closing action, it offers a robust 5mm rise and fall for seamless operation.

Powder coated folded 3 mm aluminium mechanically fixed to closing profile of the door. It is 225 mm long and positioned at 1050 mm from the floor.

Hinges are rebated on profiles, so they are flush to the edge. The 3 mm gap in between is covered with 2 single clipping seals with a deflector that stops water coming through.

Based on the same concept of a pull handle the shape brings the accent to it. It is 150 mm long and positioned at 1050.



Shower Enclosures:
Door with Return Panel

Shower doors may be paired with a range of Return/Side Panels to create Shower Cubicles. Return panels must be ordered with the door to make sure adjustment range is correct and guarantee a perfect fit.

If you want to create a Shower Enclosure please follow the steps shown on pricing pages.

Please note Across support bar will be included on price if Doors are ordered together with a return panel for stability purposes.

Configurations



LH
Shower Door
+
LH
Return Panel



LH
Shower Door
+
RH
Return Panel



RH
Shower Door
+
LH
Return Panel



RH
Shower Door
+
RH
Return Panel



FXSBCRS..
1000 mm - Across support bar
(Included when door is ordered together with Return panel)

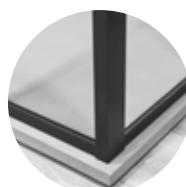

PR758..
2100 mm - Corner Channel
(Included when door is hinged from return panel)

Shower Doors & Enclosures

Steps to order:

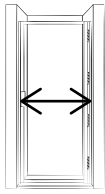

1. Choose your dimension required and if Clear Glass or Glass option needed.

2. Choose your collection; FRAME Lite, SUZHOU, DECO or BORDER



3. Choose your glass option and select the applicable price.

Item Code	Basic Price
COLDORWWL..	£Clear Glass
COLDORWWL..	£Glass Option



4. Choose your Colour/Finish option, add the two letter code and apply relevant %.

5. Add the 3 digits code Glass option when applicable

Example: BORDOR70RBK-FLU

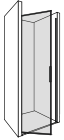

LH

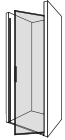

RH



FRAME Lite



SUZHOU

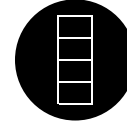

DECO

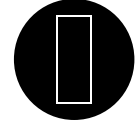

BORDER

Product Description & Dimensions	Item Code (L Left/ R Right hand version)	Basic Price		Item Code (L Left/ R Right hand version)	Basic Price		Item Code (L Left/ R Right hand version)	Basic Price		Item Code (L Left/ R Right hand version)	Basic Price	
		£Clear Glass	£Glass option		£Clear Glass	£Glass option		£Clear Glass	£Glass option		£Clear Glass	£Glass option
		Shower Door 700 x 2100 mm (L for Left Hand / R for Right Hand)	LTEDOR70L.. LTEDOR70R..		£1,496 £2,020			SUZDOR70L.. SUZDOR70R..	£1,016 £1,372			DECDOR70L.. DECDOR70R..
Shower Door 760 x 2100 mm (L for Left Hand / R for Right Hand)	LTEDOR76L.. LTEDOR76R..	£1,544 £2,084		SUZDOR76L.. SUZDOR76R..	£1,126 £1,520		DECDOR76L.. DECDOR76R..	£1,047 £1,413		BORDOR76L.. BORDOR76R..	£1,037 £1,400	
Shower Door 800 x 2100 mm (L for Left Hand / R for Right Hand)	LTEDOR80L.. LTEDOR80R..	£1,560 £2,106		SUZDOR80L.. SUZDOR80R..	£1,254 £1,693		DECDOR80L.. DECDOR80R..	£1,146 £1,547		BORDOR80L.. BORDOR80R..	£1,057 £1,427	
Shower Door 900 x 2100 mm (L for Left Hand / R for Right Hand)	LTEDOR90L.. LTEDOR90R..	£1,609 £2,172		SUZDOR90L.. SUZDOR90R..	£1,291 £1,743		DECDOR90L.. DECDOR90R..	£1,184 £1,598		BORDOR90L.. BORDOR90R..	£1,148 £1,550	

*Shower Enclosures: Door with Return Panel



LH Shower Door
+
LH Return Panel



LH Shower Door
+
RH Return Panel



RH Shower Door
+
LH Return Panel



RH Shower Door
+
RH Return Panel



6. If you need an enclosure, after knowing your door size: Choose the Return size, check the hand required and keep the code.

7. For pricing your return panel repeat the process as the door including the colour/finish % and the glass option surcharge - if applicable.

8. Order both codes together.

Product Description & Dimensions	Item Code (L Left/ R Right hand version)	Basic Price		Item Code (L Left/ R Right hand version)	Basic Price		Item Code (L Left/ R Right hand version)	Basic Price		Item Code (L Left/ R Right hand version)	Basic Price	
		£Clear Glass	£Glass option		£Clear Glass	£Glass option		£Clear Glass	£Glass option		£Clear Glass	£Glass option
		Return Panel for Shower Enclosures 700 x 2100 mm	+LTE70L.. +LTE70R..		£883 £1,192			+SUZ70L.. +SUZ70R..	£824 £1,112			+DEC70L.. +DEC70R..
Return Panel for Shower Enclosures 800 x 2100 mm	+LTE80L.. +LTE80R..	£919 £1,241		+SUZ80L.. +SUZ80R..	£860 £1,161		+DEC80L.. +DEC80R..	£836 £1,129		+BOR80L.. +BOR80R..	£821 £1,108	
Return Panel for Shower Enclosures 900 x 2100 mm	+LTE90L.. +LTE90R..	£942 £1,272		+SUZ90L.. +SUZ90R..	£913 £1,233		+DEC90L.. +DEC90R..	£859 £1,160		+BOR90L.. +BOR90R..	£841 £1,135	
Return Panel for Shower Enclosures 1000 x 2100 mm	+LTE100L.. +LTE100R..	£1,005 £1,357		+SUZ100L.. +SUZ100R..	£980 £1,323		+DEC100L.. +DEC100R..	£922 £1,245		+BOR100L.. +BOR100R..	£900 £1,215	
Return Panel for Shower Enclosures 1200 x 2100 mm	+LTE120L.. +LTE120R..	£1,225 £1,654		+SUZ120L.. +SUZ120R..	£1,189 £1,605		+DEC120L.. +DEC120R..	£1,107 £1,494		+BOR120L.. +BOR120R..	£1,015 £1,370	

All prices shown above are Excluding VAT. For dimensions that do not fit our Standard range please contact us, we are experts on Bespoke and made to measure projects. Please email us at sales@drenchshowers.co.uk.

Components:



PHAND
SPHAND
Depending on Finish



FXSBCRS
Accross
Support Bar

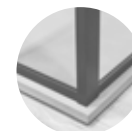

PR758
Corner
Channel

Adjustment range:

Please note DRENCH standard items are designed to fit both shower trays and wetroom installations. Please take into consideration our adjustment range as per below table.

Shower Door Adjustment Range

for Individual orders (in a recess) and Shower Enclosures (Return Panel)





Main Dimension (in mm)	Adjustment in Recess		Adjustment with Return panel	
	MATTE Colours	Metallic & Blending	MATTE Colours	Metallic & Blending
700	667 - 699	671 - 689	675 - 690	681 - 690
760	727 - 759	731 - 749	735 - 750	739 - 747
800	767 - 759	771 - 789	775 - 790	781 - 790
900	867 - 899	871 - 889	875 - 890	881 - 890

Return panel Adjustment Range

Dimension shown (in mm)	Minimum	Mid-Point (Physical size of unit in the box)	Maximum
700	675	680	690
800	775	780	790
900	875	880	890
1000	975	980	990
1200	1175	1180	1190

Metalwork Colours & Finishes

Choose your colour/finish add the two letter code to your main product code and apply the relevant % to the Basic price.

MATTE Classic	MATTE Pastel	Metallic Brushed	Blending Finishes	Metallic Polished
				
Basic Price	Basic+15%	Basic+40%	Basic+25%	Basic+50%
<p>Matt Black RAL 9005 BK</p> <p>Graphite Grey RAL 7024 GG</p> <p>Blanc RAL 9002 BL</p> <p>Total White RAL 9003 TT</p> <p>Forest RAL 6009 FO</p> <p>Grey Navy RAL 5008 GN</p>	<p>Rioja Red RAL 3005 RR</p> <p>Turquoise RAL 6034 TQ</p> <p>Burnt Orange RAL 3022 BO</p> <p>Lemon Yellow RAL 1012 LY</p> <p>Pale Pink RAL 3015 PP</p> <p>Capri Blue RAL 5019 CB</p>	<p>Brushed Brass Anodised BB</p> <p>Brushed Steel Anodised BS</p> <p>Light Bronze Anodised LB</p> <p>Dark Bronze Anodised DB</p>	<p>Chrome Anodised CH</p> <p>Gun Metal Anodised GM <small>**available from July 2024**</small></p> <p>Antique Bronze Textured Powder Coating NZ</p>	<p>Polished Brass Anodised PB</p> <p>Polished Nickel Anodised PN</p>

Glass Options

Choose your glass option add the three letter code to your order after **selecting your Glass Option price applicable.**

				
-XFL	-FLU	-BRZ	-GTN	-FRS
Crossed Fluted 8,8 mm Laminated	Fluted 8,8 mm Laminated	Bronze Tinted 10 mm Toughened	Grey Tinted 8 mm Toughened	Frosted 8 mm Satin Etch

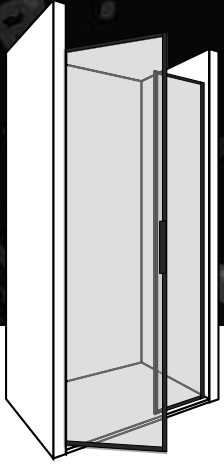

Doors with Inline & Enclosures

Experience seamless functionality with DRENCH Doors with Inline & Enclosures.

These doors are **hinged to the wall/return panel, closing into the Inline panel.**

Choose between Right or Left-hand hinges, identified by the hinge position when viewed from the outside.

Please note doors are supplied fully assembled including handle and hinge mechanism as well as bottom seal and threshold bit to guarantee watertight installation.

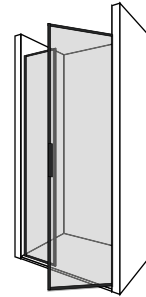

RH

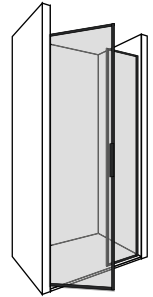

LH



Glass Options available:

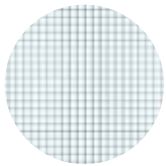

Crossed Fluted
8,8 mm Laminated



Fluted
8,8 mm Laminated

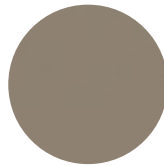

Bronze
10 mm Toughened

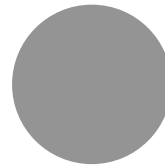

Grey Tinted
8 mm Toughened



Frosted
8 mm Satin Etch





FRAME Lite



SUZHOU



DECO



BORDER



MATTE Colours Door Features
(Architectural powder coating)

Metallic Finishes Door Features
(Anodised finishes)

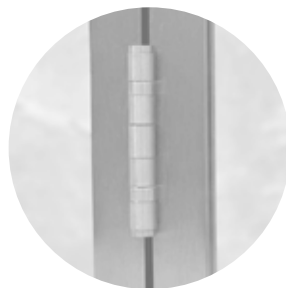

Crafted with precision, our pivot hinge mechanism features a zinc pivot casting for durability. Designed to provide a smooth swing and closing action, it offers a robust 5mm rise and fall for seamless operation.

Powder coated folded 3 mm aluminium mechanically fixed to closing profile of the door. It is 225 mm long and positioned at 1050 mm from the floor.

Hinges are rebated on profiles, so they are flush to the edge. The 3 mm gap in between is covered with 2 single clipping seals with a deflector that stops water coming through.

Based on the same concept of a pull handle the shape brings the accent to it. It is 150 mm long and positioned at 1050.



Shower Enclosures:
Door with Inline & Return Panel

Doors with inline panel may be paired with a range of Return/Side Panels to create Shower Cubicles. Return panels must be ordered with the door to make sure adjustment range is correct and guarantee a perfect fit.

If you want to create a Shower Enclosure please follow the steps shown on pricing pages.

Please note Accross support bar will be included on price if Doors are ordered together with a return panel for stability purposes.

Configurations

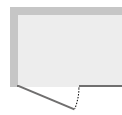

LH
Door with
Inline
+
RH
Return
Panel

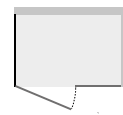

LH
Door with
Inline
+
LH
Return
Panel

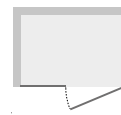

RH
Door with
Inline
+
RH
Return
Panel

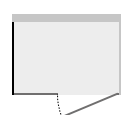

RH
Door with
Inline
+
LH
Return
Panel



FXSBPRL..
1600 mm - Parallel panel support bar
(Included when door are inline are in a recess)



FXSBDBL..
2000 mm - Return panel support bar
(Included when door is ordered together with Return panel)

Doors with Inline & Enclosures

Steps to order:

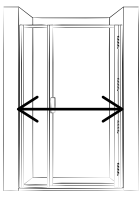

1. Choose your dimension required and if Clear Glass or Glass option needed.

2. Choose your collection; **FRAME Lite, SUZHOU, DECO or BORDER**



3. Choose your glass option and select the applicable price.

Item Code	Basic Price
COLDIW/WL. COLDIW/WR...	£Clear Glass
	£Glass Option



4. Choose your Colour/Finish option, add the two letter code and apply relevant %.

5. Add the 3 digits code Glass option when applicable

Example: BORDI70/70RBK-FLU

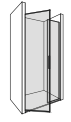

LH

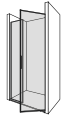

RH



FRAME Lite



SUZHOU



DECO

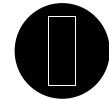

BORDER

Product Description & Dimensions	Item Code (L Left/ R Right hand version)	Basic Price		Item Code (L Left/ R Right hand version)	Basic Price		Item Code (L Left/ R Right hand version)	Basic Price	
		Clear Glass	Glass Option		Clear Glass	Glass Option		Clear Glass	Glass Option
Door with Inline panel 900 x 2100 mm (700 Door + 200 Inline)	LTEDI70/20L...	£1,889		SUZDI70/20L...	£1,393		DECDI70/20L...	£1,223	
	LTEDI70/20R...	£2,550		SUZDI70/20R...	£1,881		DECDI70/20R...	£1,651	
Door with Inline panel 1000 x 2100 mm (700 Door + 300 Inline)	LTEDI70/30L...	£1,946		SUZDI70/30L...	£1,455		DECDI70/30L...	£1,350	
	LTEDI70/30R...	£2,627		SUZDI70/30R...	£1,964		DECDI70/30R...	£1,823	
Door with Inline panel 1200 x 2100 mm (700 Door + 500 Inline)	LTEDI70/50L...	£1,870		SUZDI70/50L...	£1,622		DECDI70/50L...	£1,585	
	LTEDI70/50R...	£2,525		SUZDI70/50R...	£2,190		DECDI70/50R...	£2,140	
Door with Inline panel 1400 x 2100 mm (700 Door + 700 Inline)	LTEDI70/70L...	£2,348		SUZDI70/70L...	£2,059		DECDI70/70L...	£1,915	
	LTEDI70/70R...	£3,170		SUZDI70/70R...	£2,780		DECDI70/70R...	£2,585	
Door with Inline panel 1500 x 2100 mm (700 Door + 800 Inline)	LTEDI70/80L...	£2,439		SUZDI70/80L...	£2,126		DECDI70/80L...	£2,033	
	LTEDI70/80R...	£3,293		SUZDI70/80R...	£2,870		DECDI70/80R...	£2,745	
Door with Inline panel 1600 x 2100 mm (700 Door + 900 Inline)	LTEDI70/90L...	£2,755		SUZDI70/90L...	£2,291		DECDI70/90L...	£2,254	
	LTEDI70/90R...	£3,719		SUZDI70/90R...	£3,093		DECDI70/90R...	£3,043	

*Shower Enclosures: Door with Inline & Return Panel



LH
Door with Inline
+
RH
Return Panel



LH
Door with Inline
+
LH
Return Panel



RH
Door with Inline
+
RH
Return Panel



RH
Door with Inline
+
LH
Return Panel

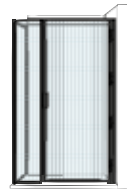

6. If you need an enclosure, after knowing your door size: Choose the Return size, check the hand required and keep the code.

For pricing your return panel repeat the process as the door including the colour/finish % and the glass option code when applicable.

7. Order both codes together.

Product Description & Dimensions	Item Code (L Left/ R Right hand version)	Basic Price		Item Code (L Left/ R Right hand version)	Basic Price		Item Code (L Left/ R Right hand version)	Basic Price	
		Clear Glass	Glass option		Clear Glass	Glass option		Clear Glass	Glass option
		Return Panel for Shower Enclosures 700 x 2100 mm	+LTE70L...		£883			+SUZ70L...	£824
	+LTE70R...	£1,192		+SUZ70R...	£1,112		+DEC70R...	£1,081	
Return Panel for Shower Enclosures 800 x 2100 mm	+LTE80L...	£919		+SUZ80L...	£860		+DEC80L...	£836	
	+LTE80R...	£1,241		+SUZ80R...	£1,161		+DEC80R...	£1,129	
Return Panel for Shower Enclosures 900 x 2100 mm	+LTE90L...	£942		+SUZ90L...	£913		+DEC90L...	£859	
	+LTE90R...	£1,272		+SUZ90R...	£1,233		+DEC90R...	£1,160	
Return Panel for Shower Enclosures 1000 x 2100 mm	+LTE100L...	£1,005		+SUZ100L...	£980		+DEC100L...	£922	
	+LTE100R...	£1,357		+SUZ100R...	£1,323		+DEC100R...	£1,245	
Return Panel for Shower Enclosures 1200 x 2100 mm	+LTE120L...	£1,225		+SUZ120L...	£1,189		+DEC120L...	£1,107	
	+LTE120R...	£1,654		+SUZ120R...	£1,605		+DEC120R...	£1,494	

Components:



PHAND SPHAND
Depending on Finish



FXSBPRL
Parallel Support Bar



FXSDBDL
Return Panel Support Bar

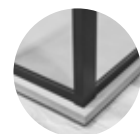

PR758
Corner Channel

Adjustment range:

Please note DRENCH standard items are designed to fit both shower trays and wetroom installations. Please take into consideration our adjustment range as per below table.

Shower Door with inline Adjustment Range

for Individual orders (in a recess) and Shower Enclosures (Return Panel)

Main Dimension (in mm)	Split DOOR/INLINE	Adjustment in Recess		Adjustment with Return panel	
		MATTE Colours	Metallic & Blending	MATTE Colours	Metallic & Blending
900	700/200	867 - 890	871 - 889	875 - 890	881 - 890
1000	700/300	967 - 990	971 - 989	975 - 990	981 - 990
1200	700/500	1167 - 1190	1171 - 1189	1175 - 1190	1181 - 1190
1400	700/700	1367 - 1390	1371 - 1389	1375 - 1390	1381 - 1390
1500	700/800	1467 - 1490	1471 - 1489	1475 - 1490	1481 - 1490
1600	700/900	1567 - 1590	1571 - 1589	1575 - 1590	1581 - 1590

Return panel Adjustment Range

Dimension shown (in mm)	Minimum	Mid-Point (Physical size of unit in the box)	Maximum
700	675	680	690
800	775	780	790
900	875	880	890
1000	975	980	990
1200	1175	1180	1190

Metalwork Colours & Finishes

Choose your colour/finish add the two letter code to your main product code and apply the relevant % to the Basic price.

MATTE Classic



Basic Price

- Matt Black RAL 9005 **BK**
- Graphite Grey RAL 7024 **GG**
- Blanc RAL 9002 **BL**
- Total White RAL 9003 **TT**
- Forest RAL 6009 **FO**
- Grey Navy RAL 5008 **GN**

MATTE Pastel



Basic+15%

- Rioja Red RAL 3005 **RR**
- Turquoise RAL 6034 **TQ**
- Burnt Orange RAL 3022 **BO**
- Lemon Yellow RAL 1012 **LY**
- Pale Pink RAL 3015 **PP**
- Capri Blue RAL 5019 **CB**

Metallic Brushed



Basic+40%

- Brushed Brass Anodised **BB**
- Brushed Steel Anodised **BS**
- Light Bronze Anodised **LB**
- Dark Bronze Anodised **DB**

Blending Finishes



Basic+25%

- Chrome Anodised **CH**
- Gun Metal Anodised **GM**
available from July 2024
- Antique Bronze Textured Powder Coating **NZ**

Metallic Polished



Basic+50%

- Polished Brass Anodised **PB**
- Polished Nickel Anodised **PN**

Glass Options

Choose your glass option add the three letter code to your order after **selecting your Glass Option price applicable.**

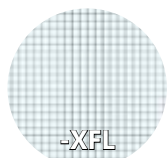

Crossed Fluted
8,8 mm Laminated



Fluted
8,8 mm Laminated



Bronze Tinted
10 mm Toughened



Grey Tinted
8 mm Toughened



Frosted
8 mm Satin Etch



Doors hinged to Inline & Enclosures

Elevate your shower space with DRENCH Doors hinged to Inline & Enclosures.

These doors are **hinged to the Inline panel, closing into the wall/return panel.**

Choose between Right or Left-hand hinges, identified by the hinge position when viewed from the outside.

Please note doors are supplied fully assembled including handle and hinge mechanism as well as bottom seal and threshold bit to guarantee watertight installation.

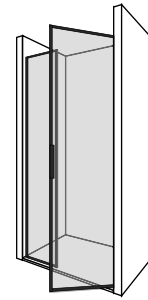

RH

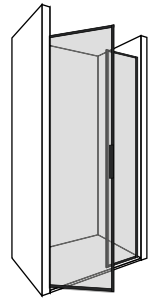

LH



Glass Options available:

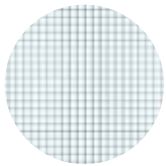

Crossed Fluted
8,8 mm Laminated



Fluted
8,8 mm Laminated

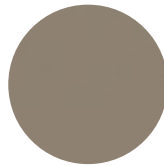

Bronze
10 mm Toughened

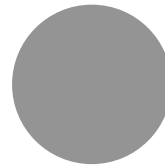

Grey Tinted
8 mm Toughened



Frosted
8 mm Satin Etch





FRAME Lite



SUZHOU



DECO



BORDER



MATTE Colours Door Features
(Architectural powder coating)

Metallic Finishes Door Features
(Anodised finishes)

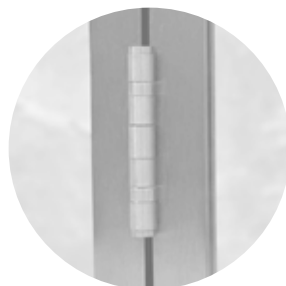

Crafted with precision, our pivot hinge mechanism features a zinc pivot casting for durability. Designed to provide a smooth swing and closing action, it offers a robust 5mm rise and fall for seamless operation.

Powder coated folded 3 mm aluminium mechanically fixed to closing profile of the door. It is 225 mm long and positioned at 1050 mm from the floor.

Hinges are rebated on profiles, so they are flush to the edge. The 3 mm gap in between is covered with 2 single clipping seals with a deflector that stops water coming through.

Based on the same concept of a pull handle the shape brings the accent to it. It is 150 mm long and positioned at 1050.



Shower Enclosures:
Door with Inline & Return Panel

Doors with inline panel may be paired with a range of Return/Side Panels to create Shower Cubicles. Return panels must be ordered with the door to make sure adjustment range is correct and guarantee a perfect fit.

If you want to create a Shower Enclosure please follow the steps shown on pricing pages.

Please note Return panel support bar will be included on price if Doors are ordered together with a return panel for stability purposes.

Configurations

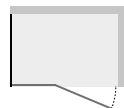

LH
Door to
Inline
+
LH
Return
Panel



LH
Door to
Inline
+
RH
Return
Panel

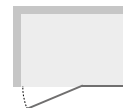

RH
Door to
Inline
+
RH
Return
Panel

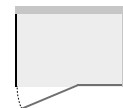

RH
Door to
Inline
+
LH
Return
Panel



FXSBPRL..
1600 mm - Parallel support bar
(Included when door are inline are in a recess)



FXSBDBL..
2000 mm - Return panel support bar
(Included when door is ordered together with Return panel)

Doors hinged to Inline & Enclosures

Steps to order:

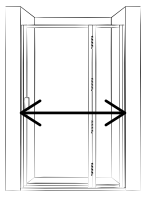

1. Choose your dimension required and if Clear Glass or Glass option needed.

2. Choose your collection; **FRAME Lite, SUZHOU, DECO or BORDER**



3. Choose your glass option and select the applicable price.

Item Code	Basic Price
COLDHW/WL..	£Clear Glass
COLDHW/WL..	£Glass Option



4. Choose your Colour/Finish option, add the two letter code and apply relevant %.

5. Add the 3 digits code Glass option when applicable

Example: BORDH70/70RBK-FLU

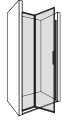

LH

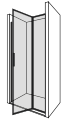

RH



FRAME Lite



SUZHOU

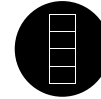

DECO

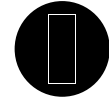

BORDER

Product Description & Dimensions	Item Code (L Left/ R Right hand version)	Basic Price		Item Code (L Left/ R Right hand version)	Basic Price		Item Code (L Left/ R Right hand version)	Basic Price		Item Code (L Left/ R Right hand version)	Basic Price	
		Clear Glass	Glass Option		Clear Glass	Glass Option		Clear Glass	Glass Option		Clear Glass	Glass Option
Door hinged to Inline panel 900 x 2100 mm (700 Door + 200 Inline)	LTEDH70/20L..	£1,889		SUZDH70/20L..	£1,393		DECDH70/20L..	£1,223		BORDH70/20L..	£1,189	
	LTEDH70/20R..	£2,550		SUZDH70/20R..	£1,881		DECDH70/20R..	£1,651		BORDH70/20R..	£1,605	
Door hinged to Inline panel 1000 x 2100 mm (700 Door + 300 Inline)	LTEDH70/30L..	£1,946		SUZDH70/30L..	£1,455		DECDH70/30L..	£1,350		BORDH70/30L..	£1,233	
	LTEDH70/30R..	£2,627		SUZDH70/30R..	£1,964		DECDH70/30R..	£1,823		BORDH70/30R..	£1,665	
Door hinged to Inline panel 1200 x 2100 mm (700 Door + 500 Inline)	LTEDH70/50L..	£1,870		SUZDH70/50L..	£1,622		DECDH70/50L..	£1,585		BORDH70/50L..	£1,387	
	LTEDH70/50R..	£2,525		SUZDH70/50R..	£2,190		DECDH70/50R..	£2,140		BORDH70/50R..	£1,872	
Door hinged to Inline panel 1400 x 2100 mm (700 Door + 700 Inline)	LTEDH70/70L..	£2,348		SUZDH70/70L..	£2,059		DECDH70/70L..	£1,915		BORDH70/70L..	£1,586	
	LTEDH70/70R..	£3,170		SUZDH70/70R..	£2,780		DECDH70/70R..	£2,585		BORDH70/70R..	£2,141	
Door hinged to Inline panel 1500 x 2100 mm (700 Door + 800 Inline)	LTEDH70/80L..	£2,439		SUZDH70/80L..	£2,126		DECDH70/80L..	£2,033		BORDH70/80L..	£1,844	
	LTEDH70/80R..	£3,293		SUZDH70/80R..	£2,870		DECDH70/80R..	£2,745		BORDH70/80R..	£2,489	
Door hinged to Inline panel 1600 x 2100 mm (700 Door + 900 Inline)	LTEDH70/90L..	£2,755		SUZDH70/90L..	£2,291		DECDH70/90L..	£2,254		BORDH70/90L..	£1,990	
	LTEDH70/90R..	£3,719		SUZDH70/90R..	£3,093		DECDH70/90R..	£3,043		BORDH70/90R..	£2,687	

*Shower Enclosures: Door hinged to Inline & Return Panel



LH
Door hinged Inline
+
LH
Return Panel



LH
Door hinged Inline
+
RH
Return Panel



RH
Door hinged Inline
+
RH
Return Panel



RH
Door hinged Inline
+
LH
Return Panel



6. If you need an enclosure, after knowing your door size: Choose the Return size, check the hand required and keep the code.

For pricing your return panel repeat the process as the door including the colour/finish % and the glass option code when applicable.

7. Order both codes together.

Product Description & Dimensions	Item Code (L Left/ R Right hand version)	Basic Price		Item Code (L Left/ R Right hand version)	Basic Price		Item Code (L Left/ R Right hand version)	Basic Price		Item Code (L Left/ R Right hand version)	Basic Price	
		Clear Glass	Glass option		Clear Glass	Glass option		Clear Glass	Glass option		Clear Glass	Glass option
		Return Panel for Shower Enclosures 700 x 2100 mm	+LTE70L..		£883			+SUZ70L..	£824			+DEC70L..
	+LTE70R..	£1,192		+SUZ70R..	£1,112		+DEC70R..	£1,081		+BOR70R..	£1,065	
Return Panel for Shower Enclosures 800 x 2100 mm	+LTE80L..	£919		+SUZ80L..	£860		+DEC80L..	£836		+BOR80L..	£821	
	+LTE80R..	£1,241		+SUZ80R..	£1,161		+DEC80R..	£1,129		+BOR80R..	£1,108	
Return Panel for Shower Enclosures 900 x 2100 mm	+LTE90L..	£942		+SUZ90L..	£913		+DEC90L..	£859		+BOR90L..	£841	
	+LTE90R..	£1,272		+SUZ90R..	£1,233		+DEC90R..	£1,160		+BOR90R..	£1,135	
Return Panel for Shower Enclosures 1000 x 2100 mm	+LTE100L..	£1,005		+SUZ100L..	£980		+DEC100L..	£922		+BOR100L..	£900	
	+LTE100R..	£1,357		+SUZ100R..	£1,323		+DEC100R..	£1,245		+BOR100R..	£1,215	
Return Panel for Shower Enclosures 1200 x 2100 mm	+LTE120L..	£1,225		+SUZ120L..	£1,189		+DEC120L..	£1,107		+BOR120L..	£1,015	
	+LTE120R..	£1,654		+SUZ120R..	£1,605		+DEC120R..	£1,494		+BOR120R..	£1,370	

Components:



PHAND SPHAND
Depending on Finish



FXSBPRL
Parallel Support Bar



FXSBDBL
Return Panel Support Bar

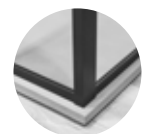

PR758
Corner Channel

Adjustment range:

Please note DRENCH standard items are designed to fit both shower trays and wetroom installations. Please take into consideration our adjustment range as per below table.

Shower Door hinged to inline Adjustment Range

for Individual orders (in a recess) and Shower Enclosures (Return Panel)

Main Dimension (in mm)	Split DOOR/INLINE	Adjustment in Recess		Adjustment with Return panel	
		MATTE Colours	Metallic & Blending	MATTE Colours	Metallic & Blending
900	700/200	869 - 890	871 - 889	875 - 890	875 - 890
1000	700/300	969 - 990	971 - 989	975 - 990	975 - 990
1200	700/500	1169 - 1190	1171 - 1189	1175 - 1190	1175 - 1190
1400	700/700	1369 - 1390	1371 - 1389	1375 - 1390	1375 - 1390
1500	700/800	1469 - 1490	1471 - 1489	1475 - 1490	1475 - 1490
1600	700/900	1569 - 1590	1571 - 1589	1575 - 1590	1575 - 1590

Return panel Adjustment Range

Dimension shown (in mm)	Minimum	Mid-Point (Physical size of unit in the box)	Maximum
700	675	680	690
800	775	780	790
900	875	880	890
1000	975	980	990
1200	1175	1180	1190

Metalwork Colours & Finishes

Choose your colour/finish add the two letter code to your main product code and apply the relevant % to the Basic price.

MATTE Classic



Basic Price

- Matt Black
RAL 9005
BK
- Graphite Grey
RAL 7024
GG
- Blanc
RAL 9002
BL
- Total White
RAL 9003
TT
- Forest
RAL 6009
FO
- Grey Navy
RAL 5008
GN

MATTE Pastel



Basic+15%

- Rioja Red
RAL 3005
RR
- Turquoise
RAL 6034
TQ
- Burnt Orange
RAL 3022
BO
- Lemon Yellow
RAL 1012
LY
- Pale Pink
RAL 3015
PP
- Capri Blue
RAL 5019
CB

Metallic Brushed



Basic+40%

- Brushed Brass
Anodised
BB
- Brushed Steel
Anodised
BS
- Light Bronze
Anodised
LB
- Dark Bronze
Anodised
DB

Blending Finishes



Basic+25%

- Chrome
Anodised
CH
- Gun Metal
Anodised
GM
available from July 2024
- Antique Bronze
Textured Powder Coating
NZ

Metallic Polished



Basic+50%

- Polished Brass
Anodised
PB
- Polished Nickel
Anodised
PN

Glass Options

Choose your glass option add the three letter code to your order after **selecting your Glass Option price applicable.**



-XFL

Crossed Fluted
8,8 mm Laminated



-FLU

Fluted
8,8 mm Laminated



-BRZ

Bronze Tinted
10 mm Toughened



-GTN

Grey Tinted
8 mm Toughened



-FRS

Frosted
8 mm Satin Etch

TOUCHES Collection

MATTE Colours and Metallic finishes merge seamlessly in our TOUCHES Collection offering a high level of customisation.

We want to manufactured your favourite choice of MATTE and metallic finishes. It is all about matching and we know it.

Shower Door frames and spare parts are finished in a MATTE Colour using architectural powder coating and the little touches like Hinges and Pull Handle are finished in Metallic.

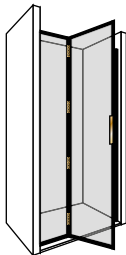
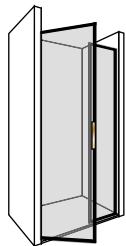
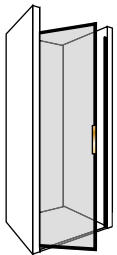

+TOUCHBB
Brushed Brass
Pull Handle & Hinges



+TOUCHBS
Brushed Steel
Pull Handle & Hinges



+TOUCHLB
Light Bronze
Pull Handle & Hinges



+TOUCHDB
Dark Bronze
Pull Handle & Hinges

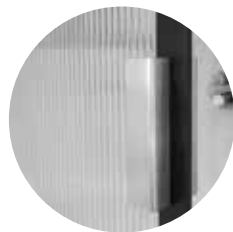

+TOUCHCH
Polished Chrome
Pull Handle & Hinges

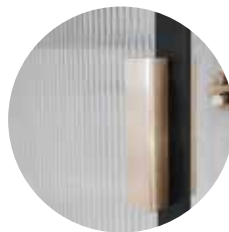

+TOUCHPN
Polished Nickel
Pull Handle & Hinges

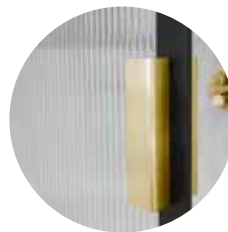

+TOUCHPB
Polished Brass
Pull Handle & Hinges





Shower Doors
& Enclosures

























Doors with Inline
& Enclosures



Doors hinged to Inline
& Enclosures

Standard Dimensions Vs **Product Configuration**

	300	400	500	600	700	800	900	1000	1200	1400	1500	1600
 Single Shower Doors Standard Height 2100 mm	×	×	×	×				×	×	×	×	×
 Shower Doors with Inline Panel Standard Height 2100 mm	×	×	×	×	×	×						
 Shower Doors hinged to Inline Panel Standard Height 2100 mm	×	×	×	×	×	×						
 Return Panels for Shower Enclosures Standard Height 2100 mm	×	×	×	×					×	×	×	×

TOUCHES Shower Doors & Enclosures

All codes below include the product as well as all items required for installation. Please check adjustment range as well as components section below to guarantee a correct fit.

Please note Shower Doors are handed so left or right hand must be specified.

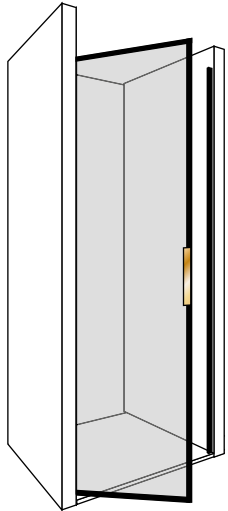

Steps to order:

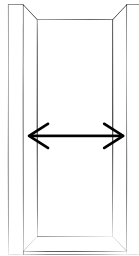

1. Choose your required dimension and keep the main code & Basic price.

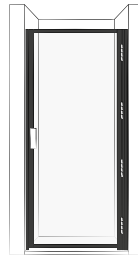

2. Choose the MATTE colour for door frame and add the 2 letter to your code. Apply % to Basic price if Pastel colours chosen.



3. Choose the metallic touch and add the code to your order. All TOUCHES are included on Basic price.



4. Choose your desired Glass option and add the 3 letters to your code. Please note Clear Glass and Glass Option Basic price.

*Shower Doors

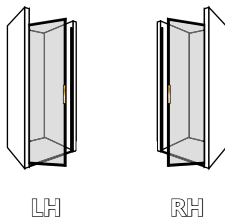

LH

RH

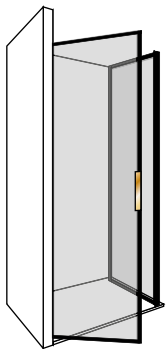

Product Code	Description & Dimensions	Adjustment Range in a recess	Adjustment Range with Return Panel	Basic Price	
				£Clear Glass	£Glass option
TOUDOR70L... TOUDOR70R...	Shower Door 700 x 2100 mm L: Left Hand / R: Right Hand	671 - 689 mm	681 - 690 mm	£1,275	£1,721
TOUDOR76L... TOUDOR76R...	Shower Door 760 x 2100 mm L: Left Hand / R: Right Hand	721 - 739 mm	739 - 747 mm	£1,398	£1,887
TOUDOR80L... TOUDOR80R...	Shower Door 800 x 2100 mm L: Left Hand / R: Right Hand	771 - 789 mm	781 - 790 mm	£1,469	£1,983
TOUDOR90L... TOUDOR90R...	Shower Door 900 x 2100 mm L: Left Hand / R: Right Hand	871 - 889 mm	881 - 890 mm	£1,636	£2,209

*Shower Enclosures: Door with Return Panel

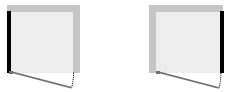

LH
Shower Door
+
LH
Return

LH
Shower Door
+
RH
Return



RH
Shower Door
+
LH
Return



RH
Shower Door
+
RH
Return

Product Code	Description & Dimensions	Adjustment Range with Return Panel	Basic Price	
			£Clear Glass	£Glass option
+TOU70L... +TOU70R...	Return Panel for Shower Enclosures 700 x 2100 mm L: Left Hand / R: Right Hand	675 - 690 mm	£789	£1,065
+TOU80L... +TOU80R...	Return Panel for Shower Enclosures 800 x 2100 mm L: Left Hand / R: Right Hand	775 - 790 mm	£821	£1,108
+TOU90L... +TOU90R...	Return Panel for Shower Enclosures 900 x 2100 mm L: Left Hand / R: Right Hand	875 - 890 mm	£841	£1,135
+TOU100L... +TOU100R...	Return Panel for Shower Enclosures 1000 x 2100 mm L: Left Hand / R: Right Hand	975 - 990 mm	£900	£1,215
+TOU120L... +TOU120R...	Return Panel for Shower Enclosures 1200 x 2100 mm L: Left Hand / R: Right Hand	1175 - 1190 mm	£1,015	£1,370

For dimensions that do not fit our Standard range please contact us, we are experts on Bespoke and made to measure projects. Please email us at sales@drenchshowers.co.uk

Components:



FXSBCRS
Accross
Support Bar

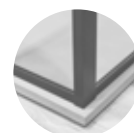

PR758
Corner
Channel



2. Choose your MATTE finish

MATTE Classic

Basic Price



Basic

Matt Black
RAL 9005

BK

Graphite Grey
RAL 7024

GG

Blanc
RAL 9002

BL

Total White
RAL 9003

TT

Forest
RAL 6009

FO

Grey Navy
RAL 5008

GN

MATTE Pastel

Basic + 15%

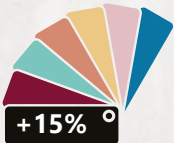

+ 15%

Rioja Red
RAL 3005

RR

Turquoise
RAL 6034

TQ

Burnt Orange
RAL 3022

BO

Lemon Yellow
RAL 1012

LY

Pale Pink
RAL 3015

PP

Capri Blue
RAL 5019

CB



3. Choose your TOUCH



+TOUCHBB
Brushed Brass



+TOUCHBS
Brushed Steel

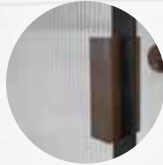

+TOUCHDB
Dark Bronze



+TOUCHLB
Light Bronze



+TOUCHCH
Polished Chrome



+TOUCHPN
Polished Nickel



+TOUCHPB
Polished Brass



4. Choose your Glass Option

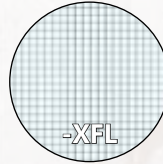

-XFL
Crossed Fluted
8,8 mm Laminated

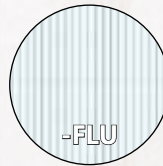

-FLU
Fluted
8,8 mm Laminated



-BRZ
Bronze
10 mm Toughened



-GTN
Grey Tinted
8 mm Toughened

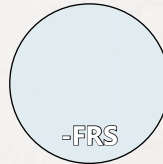





-FRS
Frosted
8 mm Satin Etch

TOUCHES Shower Door with Inline & Enclosures

All codes below include the product as well as all items required for installation. Please check adjustment range as well as components section below to guarantee a correct fit.

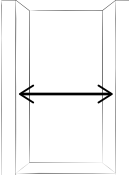
Please note Shower Doors are handed so left or right hand must be specified.

Steps to order:

-  1. Choose your required dimension and keep the main code & Basic price.
-  2. Choose the MATTE colour for door frame and add the 2 letter to your code. Apply % to Basic price if Pastel colours chosen.
-  3. Choose the metallic touch and add the code to your order. All TOUCHES are included on Basic price.
-  4. Choose your desired Glass option and add the 3 letters to your code. Please note Clear Glass and Glass Option Basic price.

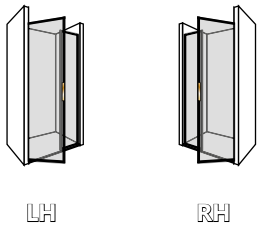
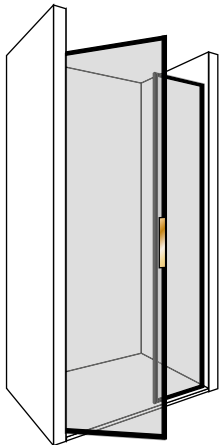

*Shower Door with Inline

Product Code	Description & Dimensions	Adjustment Range in a recess	Adjustment Range with Return Panel	Basic Price	
				£Clear Glass	£Glass option
TOUDI70/20L.. TOUDI70/20R..	Door with Inline panel 900 x 2100 mm (700 Door + 200 Inline)	871 - 889 mm	981 - 990 mm	£1,636	£2,209
TOUDI70/30L.. TOUDI70/30R..	Door with Inline panel 1000 x 2100 mm (700 Door + 300 Inline)	971 - 989 mm	981 - 990 mm	£1,781	£2,404
TOUDI70/50L.. TOUDI70/50R..	SDoor with Inline panel 1200 x 2100 mm (700 Door + 500 Inline)	1171 - 1189 mm	1181 - 1190 mm	£2,080	£2,808
TOUDI70/70L.. TOUDI70/70R..	Door with Inline panel 1400 x 2100 mm (700 Door + 700 Inline)	1371 - 1389 mm	1381 - 1390 mm	£2,265	£3,058
TOUDI70/80L.. TOUDI70/80R..	Door with Inline panel 1500 x 2100 mm (700 Door + 800 Inline)	1471 - 1489 mm	1481 - 1490 mm	£2,513	£3,393
TOUDI70/90L.. TOUDI70/90R..	Door with Inline panel 1600 x 2100 mm (700 Door + 900 Inline)	1571 - 1359 mm	1581 - 1590 mm	£2,686	£3,626

*Shower Enclosures: Door with Inline & Return Panel

Product Code	Description & Dimensions	Adjustment Range with Return Panel	Basic Price	
			£Clear Glass	£Glass option
+TOU70L.. +TOU70R..	Return Panel for Shower Enclosures 700 x 2100 mm L: Left Hand / R: Right Hand	675 - 690 mm	£789	£1,065
+TOU80L.. +TOU80R..	Return Panel for Shower Enclosures 800 x 2100 mm L: Left Hand / R: Right Hand	775 - 790 mm	£821	£1,108
+TOU90L.. +TOU90R..	Return Panel for Shower Enclosures 900 x 2100 mm L: Left Hand / R: Right Hand	875 - 890 mm	£841	£1,135
+TOU100L.. +TOU100R..	Return Panel for Shower Enclosures 1000 x 2100 mm L: Left Hand / R: Right Hand	975 - 990 mm	£900	£1,215
+TOU120L.. +TOU120R..	Return Panel for Shower Enclosures 1200 x 2100 mm L: Left Hand / R: Right Hand	1175 - 1190 mm	£1,015	£1,370

For dimensions that do not fit our Standard range please contact us, we are experts on Bespoke and made to measure projects. Please email us at sales@drenchshowers.co.uk

Components:



PHAND SPHAND
+TOUCH..



FXSBDBL
Return Panel Support Bar

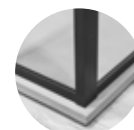

PR758
Corner Channel



2. Choose your MATTE finish

MATTE Classic

Basic Price



Matt Black
RAL 9005

BK

Graphite Grey
RAL 7024

GG

Blanc
RAL 9002

BL

Total White
RAL 9003

TT

Forest
RAL 6009

FO

Grey Navy
RAL 5008

GN

MATTE Pastel

Basic + 15%

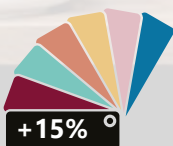

Rioja Red
RAL 3005

RR

Turquoise
RAL 6034

TQ

Burnt Orange
RAL 3022

BO

Lemon Yellow
RAL 1012

LY

Pale Pink
RAL 3015

PP

Capri Blue
RAL 5019

CB



3. Choose your TOUCH



+TOUCHBB
Brushed Brass



+TOUCHBS
Brushed Steel



+TOUCHDB
Dark Bronze



+TOUCHLB
Light Bronze



+TOUCHCH
Polished Chrome



+TOUCHPN
Polished Nickel



+TOUCHPB
Polished Brass



4. Choose your Glass Option (+35%)

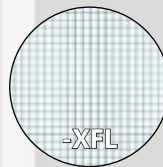

-XFL
Crossed Fluted
8,8 mm Laminated



-FLU
Fluted
8,8 mm Laminated



-BRZ
Bronze
10 mm Toughened



-GTN
Grey Tinted
8 mm Toughened

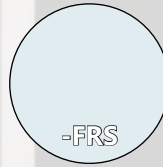

-FRS
Frosted
8 mm Satin Etch





TOUCHES

Shower Door hinged to Inline & Enclosures

All codes below include the product as well as all items required for installation. Please check adjustment range as well as components section below to guarantee a correct fit.

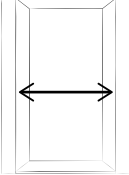
Please note Shower Doors are handed so left or right hand must be specified.

Steps to order:

-  1. Choose your required dimension and keep the main code & Basic price.
-  2. Choose the MATTE colour for door frame and add the 2 letter to your code. Apply % to Basic price if Pastel colours chosen.
-  3. Choose the metallic touch and add the code to your order. All TOUCHES are included on Basic price.
-  4. Choose your desired Glass option and add the 3 letters to your code. Please note Clear Glass and Glass Option Basic price.

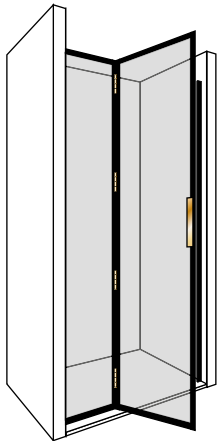

LH



RH



LH
Door to
Inline
+
LH
Return Panel

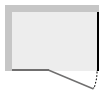

LH
Door to
Inline
+
RH
Return Panel



RH
Door to
Inline
+
RH
Return Panel

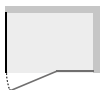

RH
Door to
Inline
+
LH
Return Panel

*Shower Door hinged to Inline

Product Code	Description & Dimensions	Adjustment Range in a recess	Adjustment Range with Return Panel	Basic Price	
				£Clear Glass	£Glass option
TOUDH70/20L... TOUDH70/20R...	Door hinged to Inline panel 900 x 2100 mm (700 Door + 200 Inline)	871 - 889 mm	981 - 990 mm	£1,636	£2,209
TOUDH70/30L... TOUDH70/30R...	Door hinged to Inline panel 1000 x 2100 mm (700 Door + 300 Inline)	971 - 989 mm	981 - 990 mm	£1,781	£2,404
TOUDH70/50L... TOUDH70/50R...	Door hinged to Inline panel 1200 x 2100 mm (700 Door + 500 Inline)	1171 - 1189 mm	1181 - 1190 mm	£2,080	£2,808
TOUDH70/70L... TOUDH70/70R...	Door hinged to Inline panel 1400 x 2100 mm (700 Door + 700 Inline)	1371 - 1389 mm	1381 - 1390 mm	£2,265	£3,058
TOUDH70/80L... TOUDH70/80R...	Door hinged to Inline panel 1500 x 2100 mm (700 Door + 800 Inline)	1471 - 1489 mm	1481 - 1490 mm	£2,513	£3,393
TOUDH70/90L... TOUDH70/90R...	Door hinged to Inline panel 1600 x 2100 mm (700 Door + 900 Inline)	1571 - 1359 mm	1581 - 1590 mm	£2,686	£3,626

*Shower Enclosures: Door hinged to Inline & Return Panel

Product Code	Description & Dimensions	Adjustment Range with Return Panel	Basic Price	
			£Clear Glass	£Glass option
+TOU70L... +TOU70R...	Return Panel for Shower Enclosures 700 x 2100 mm L: Left Hand / R: Right Hand	675 - 690 mm	£789	£1,065
+TOU80L... +TOU80R...	Return Panel for Shower Enclosures 800 x 2100 mm L: Left Hand / R: Right Hand	775 - 790 mm	£821	£1,108
+TOU90L... +TOU90R...	Return Panel for Shower Enclosures 900 x 2100 mm L: Left Hand / R: Right Hand	875 - 890 mm	£841	£1,135
+TOU100L... +TOU100R...	Return Panel for Shower Enclosures 1000 x 2100 mm L: Left Hand / R: Right Hand	975 - 990 mm	£900	£1,215
+TOU120L... +TOU120R...	Return Panel for Shower Enclosures 1200 x 2100 mm L: Left Hand / R: Right Hand	1175 - 1190 mm	£1,015	£1,370

For dimensions that do not fit our Standard range please contact us, we are experts on Bespoke and made to measure projects. Please email us at sales@drenchshowers.co.uk

Components:



PHAND
SPHAND
+TOUCH..



FXSBDBL
Return Panel
Support Bar

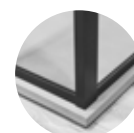

PR758
Corner
Channel

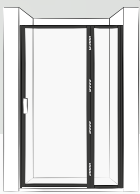

2. Choose your MATTE finish

MATTE Classic

Basic Price



Basic

Matt Black
RAL 9005

BK

Graphite Grey
RAL 7024

GG

Blanc
RAL 9002

BL

Total White
RAL 9003

TT

Forest
RAL 6009

FO

Grey Navy
RAL 5008

GN

MATTE Pastel

Basic + 15%

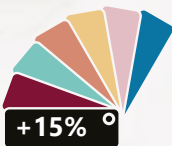

+ 15%

Rioja Red
RAL 3005

RR

Turquoise
RAL 6034

TQ

Burnt Orange
RAL 3022

BO

Lemon Yellow
RAL 1012

LY

Pale Pink
RAL 3015

PP

Capri Blue
RAL 5019

CB



3. Choose your TOUCH



+TOUCHBB
Brushed Brass



+TOUCHBS
Brushed Steel



+TOUCHDB
Dark Bronze



+TOUCHLB
Light Bronze



+TOUCHCH
Polished Chrome



+TOUCHPN
Polished Nickel



+TOUCHPB
Polished Brass



4. Choose your Glass Option (+35%)

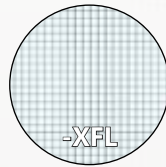

-XFL
Crossed Fluted
8,8 mm Laminated

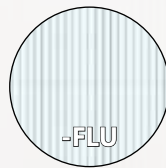

-FLU
Fluted
8,8 mm Laminated



-BRZ
Bronze
10 mm Toughened

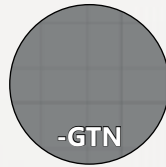

-GTN
Grey Tinted
8 mm Toughened

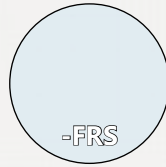

-FRS
Frosted
8 mm Satin Etch



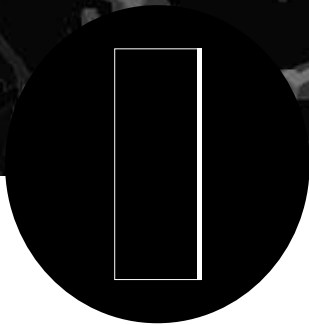

EDGE Collection

Semi Frameless Panels

A Semi frameless panel features a mix of framed glass and frameless glass.

DRENCH Showers, experts on different finishes and colours as well as glass options; designed the EDGE collection for those that are looking for simplistic and sleek look.

Wall channel and support bar add the accent of colour to the panel and the glass can be ordered Clear, Fluted or Bronze option.

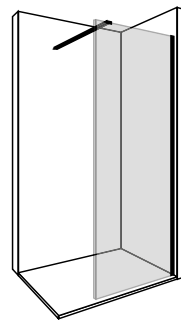

Wall Fixed

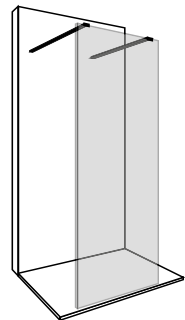

Free Standing

Support bars for Panel Combinations

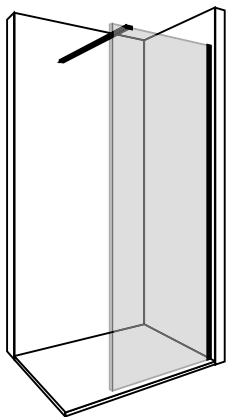

FLSCRS

Across Support Bar

Support Bar is installed across the wall. It is supplied at 1000 mm length. Support bar includes wall connector, panel connector & bar.

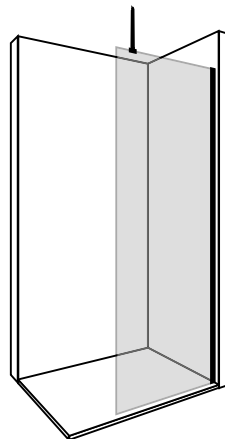

FLSCLN

Ceiling Support Bar

Support Bar is installed from the top of the screen up to the ceiling. It is supplied at 450 mm length. Support bar includes ceiling connector, panel connector & bar.

For panels wider than 1000 mm, 2 support bars may be required.

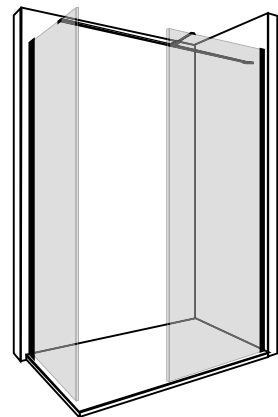

FLSTBAR

T Shape Support Bar

Support Bar is installed parallel to the longer side of the walk in shower. Support bar includes wall connector, t-shape connector panel connector & 2 x bars.



8 & 10 mm Toughened
Clear Glass

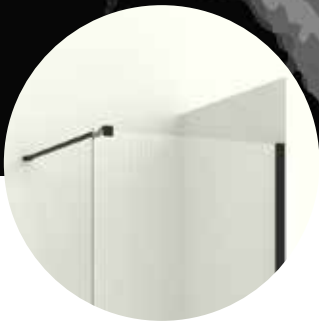

8 mm Toughened
Fluted Glass



10 mm Toughened
Bronze Tinted



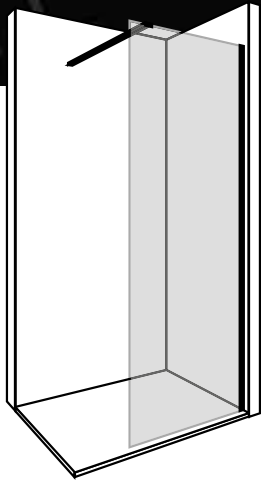

EDGE Collection

Semiframeless Shower Panels

At DRENCH we also like simplistic and sleek designs, therefore, the EDGE collection is now available. Our Semi frameless range of Shower panels are equipped with a greater strength piece of glass, both Clear and Fluted are available. Wall channel and support bar finished in the desired colour option, both MATTE colours and Metallic finishes are available.

Steps for ordering:

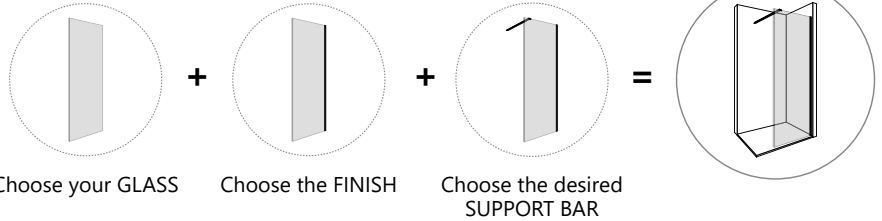

Sample layouts

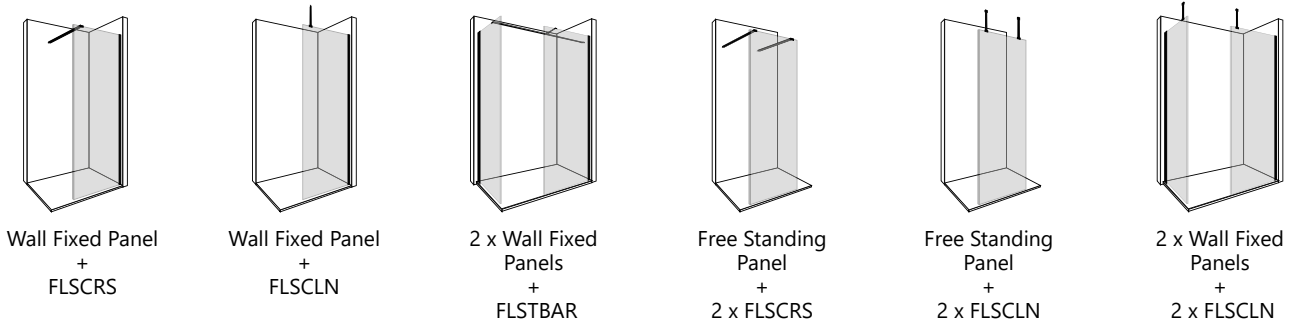

Glass Options

Please choose your GLASS size and thickness and add the code to your order. Please NOTE both 8 and 10 mm are available in clear glass whereas Fluted and Bronze are only available in 8 and 10 respectively.

RRP Ex VAT Prices

8 mm Glass

10 mm Glass

Item Code	Item Description	Adjustment (Min - Max)	RRP Ex VAT Prices			
			CLEAR GLASS -8CLR	FLUTED GLASS -FLT	CLEAR GLASS -10CLR	BRONZE TINTED -BRZ
GLS30...	Toughened Glass for Semi Frameless Panel 280 x 1981 mm	273 - 288	£112	-	£129	£160
GLS40...	Toughened Glass for Semi Frameless Panel 380x 1981 mm	373 - 388	£136	-	£156	£194
GLS50...	Toughened Glass for Semi Frameless Panel 480 x 1981 mm	473 - 488	£158	£395	£182	£226
GLS60...	Toughened Glass for Semi Frameless Panel 580 x 1981 mm	573 - 588	£182	£467	£209	£259
GLS70...	Toughened Glass for Semi Frameless Panel 680 x 1981 mm	673 - 688	£205	£540	£236	£293
GLS76...	Toughened Glass for Semi Frameless Panel 740 x 1981 mm	733 - 748	£215	£579	£247	£307
GLS80...	Toughened Glass for Semi Frameless Panel 780 x 1981 mm	773 - 788	£229	£612	£263	£327
GLS90...	Toughened Glass for Semi Frameless Panel 880 x 1981 mm	873 - 888	£253	£685	£290	£360
GLS100...	Toughened Glass for Semi Frameless Panel 980 x 1981 mm	973 - 988	£276	£757	£317	£394
GLS110...	Toughened Glass for Semi Frameless Panel 1080 x 1981 mm	1073 - 1088	£300	£830	£345	£427
GLS120...	Toughened Glass for Semi Frameless Panel 1180 x 1981 mm	1173 - 1188	£322	£902	£370	£459
GLS140...	Toughened Glass for Semi Frameless Panel 1380 x 1981 mm	1373 - 1388	£362	£1,040	£416	£516

Wall Profiles

Please choose your profile depending on glass thickness desired. (8 or 10 mm glass are available)
Add the two letter code to your profile code and apply the relevant % to the Basic price.

Item Description	8 mm Glass	Basic Price Exc VAT	10 mm Glass	Basic Price Exc VAT
Wall Channel for Semiframeless Shower Panel for a 1981 mm height.	PR8..	£142	PR10..	£157

Support Bars

Please choose your support bar and add the two letter code to your profile code and apply the relevant % to the Basic price.

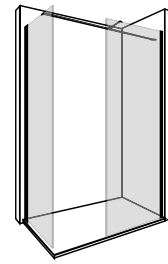
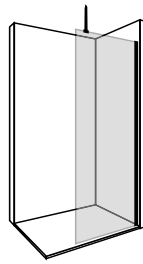
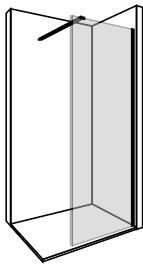

Item Code	Basic Price Exc VAT	Item Code	Basic Price Exc VAT	Item Code	Basic Price Exc VAT
FLSCRS..	£104	FLSCLN..	£115	FLSTBAR..	£153



Across Support Bar
(3 components, not pre-assembled)
1000 mm length, 30 x 10 mm bar.

Ceiling Support bar
(3 components, not pre-assembled)
450 mm length, 30 x 10 mm bar.
Suitable for ceiling distance no higher than 400 mm

T-Shape Support bar
(4 components, not pre-assembled)
2x 30 x 10 mm bars.
Long bar 1200 mm + Short bar at 1000 mm
Suitable for Shower Panels combinations

Metalwork Colours & Finishes

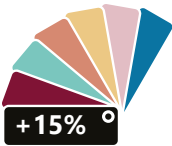
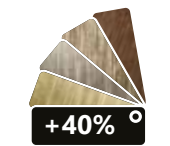
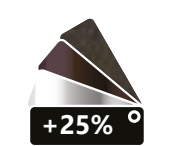
Choose your colour/finish add the two letter code to your main product code and apply the relevant % to the Basic price.

MATTE Classic	MATTE Pastel	Metallic Brushed	Blending Finishes	Metallic Polished
Basic Price	Basic +15%	Basic +40%	Basic +25%	Basic +50%
 Basic	 +15%	 +40%	 +25%	 +50%
Matt Black RAL 9005 BK	Rioja Red RAL 3005 RR	Brushed Brass Anodised BB	Chrome Anodised CH	Polished Brass Anodised PB
Graphite Grey RAL 7024 GG	Turquoise RAL 6034 TQ	Brushed Steel Anodised BS	Gun Metal Anodised GM <small>**available from July 2024**</small>	Polished Nickel Anodised PN
Blanc RAL 9002 BL	Burnt Orange RAL 3022 BO	Light Bronze Anodised LB	Antique Bronze Textured Powder Coating NZ	
Total White RAL 9003 TT	Lemon Yellow RAL 1012 LY	Dark Bronze Anodised DB		
Forest RAL 6009 FO	Pale Pink RAL 3015 PP			
Grey Navy RAL 5008 GN	Capri Blue RAL 5019 CB			

BASE

SHOWER TRAYS COLLECTION

Exclusively designed for DRENCH Showers by one of the most reputed shower tray manufacturers in the European Bathroom Industry. BASE collection presents our range of slate textured shower trays to match and be used along with our Shower Panels and Enclosures.

The Shower Trays main component is polyurethane resin. This is a material of high quality, resistance, durability and elasticity. Its impact resistance and its resistance to bending, make the tray durable and resistant to breakage.

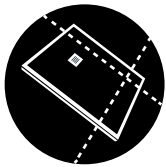
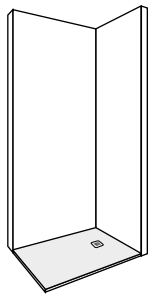

Easy to customise

BASE Shower Trays can be cut along both the length and width. They can be cut up to three times to adapt to spaces such as columns or projections. Cutting tools like jig saws or angle grinders with diamond blades are suitable for the job.



Bacterial Resistant

The coating technology used during manufacturing gives unique qualities which help the surface with fungicidal, antibacterial and hydrophobic properties. As a result, the shower trays are not only easy cleanable, but also actively help to keep surfaces decontaminated.



Easy to Install

BASE Shower trays can be installed flat to tiles, on top of flooring or even using a raising up. Shower tray thickness of 25 mm contributes to an easy installation plus offers versatility of suitable scenarios.



Non-Slip Surface

BASE Shower Trays have a matte, non-slip surface which is given by the texture and material used. Effectively preventing slip hazards.

Colour Options

Slate texture

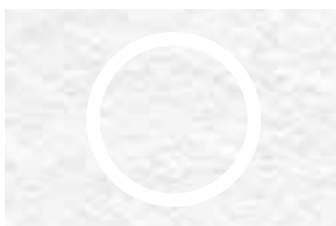

Total White
(TT)
RAL 9003

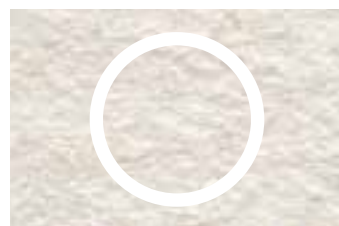

Blanc
(BL)
RAL 9002



Dusty Grey
(DG)
RAL 7037



Graphite Grey
(GG)
RAL 7024



Standard dimensions

(in mm) / x means size is not available.

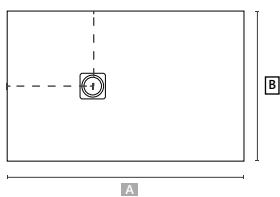

	A	800	900	1000	1200	1400	1500	1600	1700	1800	2000
B											
700 mm		×	×	📏	📏	📏	×	📏	📏	📏	📏
800 mm		📏	×	📏	📏	📏	📏	📏	📏	📏	📏
900 mm		×	📏	📏	📏	📏	📏	📏	📏	📏	📏



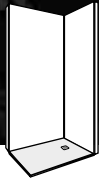

BAS

SHOWER TRAYS COLLECTION

With four colour options and different grating styles, we encourage your mind to be creative. BASE Shower Trays include both Standard Stainless Steel Grating & McAlpine Waste on price.

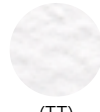

(TT)

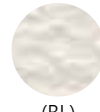

(BL)



(DG)

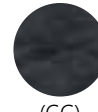

(GG)

Item Description A x B (mm)	Drain position C & D (mm)	Total White Code	Blanc Code	Dusty Grey Code	Graphite Grey Code	Retail Price (Exc VAT)
Shower Tray Slate texture 800 x 800 mm	C: 200 D: 400	BAS8080TT	BAS8080BL	BAS8080DG	BAS8080GG	£527
Shower Tray Slate texture 900 x 900 mm	C: 200 D: 450	BAS9090TT	BAS9090BL	BAS9090DG	BAS9090GG	£603
Shower Tray Slate texture 1000 x 700 mm	C: 200 D: 350	BAS10070TT	BAS10070BL	BAS10070DG	BAS10070GG	£538
Shower Tray Slate texture 1000 x 800 mm	C: 200 D: 400	BAS10080TT	BAS10080BL	BAS10080DG	BAS10080GG	£577
Shower Tray Slate texture 1000 x 900 mm	C: 200 D: 450	BAS10090TT	BAS10090BL	BAS10090DG	BAS10090GG	£601
Shower Tray Slate texture 1200 x 700 mm	C: 250 D: 350	BAS12070TT	BAS12070BL	BAS12070DG	BAS12070GG	£610
Shower Tray Slate texture 1200 x 800 mm	C: 250 D: 400	BAS12080TT	BAS12080BL	BAS12080DG	BAS12080GG	£616
Shower Tray Slate texture 1200 x 900 mm	C: 250 D: 450	BAS12090TT	BAS12090BL	BAS12090DG	BAS12090GG	£686
Shower Tray Slate texture 1400 x 700 mm	C: 300 D: 350	BAS14070TT	BAS14070BL	BAS14070DG	BAS14070GG	£639
Shower Tray Slate texture 1400 x 800 mm	C: 300 D: 400	BAS14080TT	BAS14080BL	BAS14080DG	BAS14080GG	£709
Shower Tray Slate texture 1400 x 900 mm	C: 300 D: 450	BAS14090TT	BAS14090BL	BAS14090DG	BAS14090GG	£767
Shower Tray Slate texture 1500 x 800 mm	C: 600 D: 400	BAS15080TT	BAS15080BL	BAS15080DG	BAS15080GG	£799
Shower Tray Slate texture 1500 x 900 mm	C: 600 D: 450	BAS15090TT	BAS15090BL	BAS15090DG	BAS15090GG	£864
Shower Tray Slate texture 1600 x 700 mm	C: 600 D: 350	BAS16070TT	BAS16070BL	BAS16070DG	BAS16070GG	£737
Shower Tray Slate texture 1600 x 800 mm	C: 600 D: 400	BAS16080TT	BAS16080BL	BAS16080DG	BAS16080GG	£804
Shower Tray Slate texture 1600 x 900 mm	C: 600 D: 450	BAS16090TT	BAS16090BL	BAS16090DG	BAS16090GG	£871
Shower Tray Slate texture 1700 x 700 mm	C: 600 D: 350	BAS17070TT	BAS17070BL	BAS17070DG	BAS17070GG	£793
Shower Tray Slate texture 1700 x 800 mm	C: 600 D: 400	BAS17080TT	BAS17080BL	BAS17080DG	BAS17080GG	£865
Shower Tray Slate texture 1700 x 900 mm	C: 600 D: 450	BAS17090TT	BAS17090BL	BAS17090DG	BAS17090GG	£939
Shower Tray Slate texture 1800 x 700 mm	C: 600 D: 350	BAS18070TT	BAS18070BL	BAS18070DG	BAS18070GG	£808
Shower Tray Slate texture 1800 x 800 mm	C: 600 D: 400	BAS18080TT	BAS18080BL	BAS18080DG	BAS18080GG	£879
Shower Tray Slate texture 1800 x 900 mm	C: 600 D: 450	BAS18090TT	BAS18090BL	BAS18090DG	BAS18090GG	£961
Shower Tray Slate texture 2000 x 700 mm	C: 600 D: 350	BAS20070TT	BAS20070BL	BAS20070DG	BAS20070GG	£1,007
Shower Tray Slate texture 2000 x 800 mm	C: 600 D: 400	BAS20080TT	BAS20080BL	BAS20080DG	BAS20080GG	£1,099
Shower Tray Slate texture 2000 x 900 mm	C: 600 D: 450	BAS20090TT	BAS20090BL	BAS20090DG	BAS20090GG	£1,159

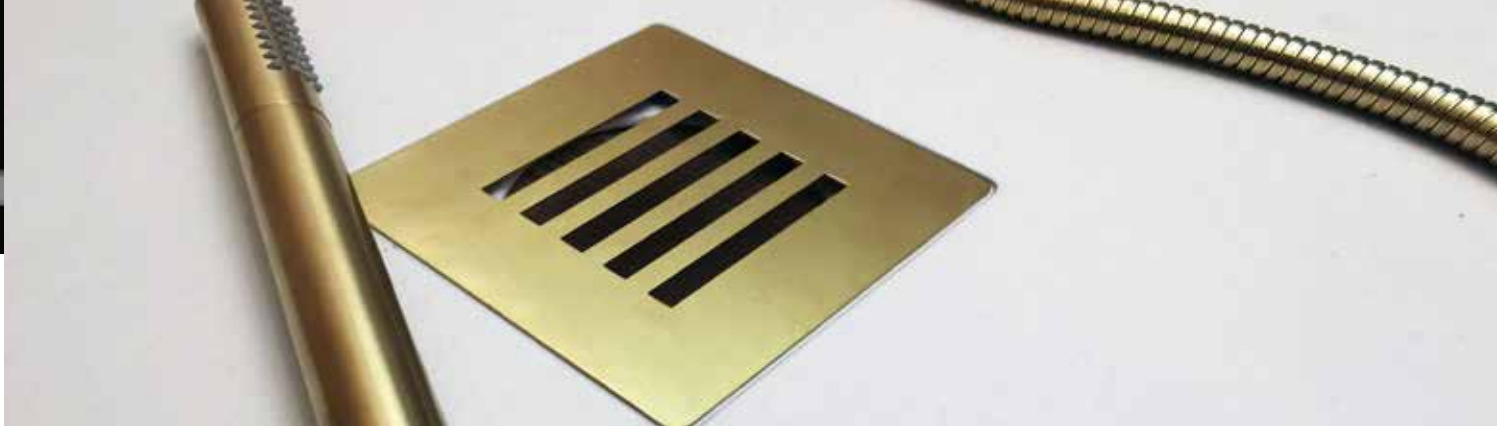

Standard Grating

Stainless steel grating
130 x 130 mm
Included in price.

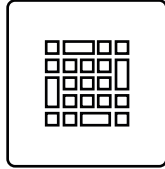

BASE Grating

Stainless steel grating
130 x 130 mm
Finish must be chosen
when ordering. Not included
on Shower tray price.

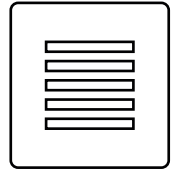

Grating is included on price of Shower tray.

Please select your colour/finish and add the code & price as per below:

MATTE Colour Grates

Item Description	Total White	Blanc	Dusty Grey	Graphite Grey	RRP Price Exc VAT
MATTE Colour matching Powder coated grate matching shower tray colour. Blanc, Total White, Dusty Grey & Graphite Grey.					£52
	BASGTTT	BASGTBL	BASGTDG	BASGTGG	

Metallic Finish Grates

Item Description	Brushed Brass	Brushed Steel	Dark Bronze	Light Bronze	RRP Price Exc VAT
Metallic Finish matching Metallic finish grate matching shower tray colour. Brushed Brass, Brushed Steel, Dark & Light Bronze.					£105
	BASGTBB	BASGTBS	BASGTDB	BASGTLB	



Installation Kit

An installation kit specifically designed for BASE Shower trays are available as per request. Installation kits includes:

- **CLASSI Seal Flexible waterproof** upstand to guarantee full watertight conditions between your tiles and the shower tray.
- **CT1 Multi-Purpose Sealant & Adhesive** 300 ml (2 tubes) for Shower tray installation.

Installation kit Available	Shower Tray installation kit including CLASSI Seal Flexible waterproof upstand & 2 PU Adhesive tubes 300 ml, SIKAFLEX	BASKIT	+£118
-----------------------------------	--	---------------	--------------

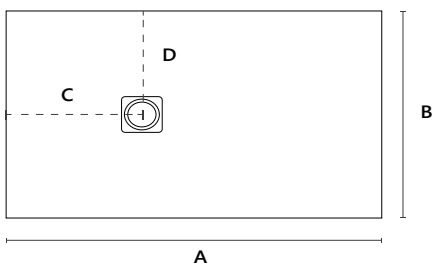

PLEASE NOTE

The waste position vary depending on the Shower tray dimensions. Please follow the drawing and dimensions specified on "Drain position" on previous page to check the position of your waste.

Waste position cannot be changed however Shower trays can be cut.
For Shower Tray BESPOKE CUTTING please add BASCUT +£ 99.00 to prices above.
For any further enquiry, please contact us sales@drenchshowers.co.uk

Bespoke Service

DRENCH prides itself on its bespoke approach, crafting each piece to perfection according to your specifications.

Whether it's a simple adjustment in dimensions or the creation of a complex shower enclosure, we're here to bring your vision to life.

Our cutting-edge manufacturing facilities in the UK enable us to offer a comprehensive made-to-measure service, ensuring prompt delivery without compromising on quality.

Explore the endless possibilities with DRENCH. From custom glass options to fabric interlayers, we provide a range of materials and finishes to suit your unique style and preferences.

Our catalogue not only inspires your design but also showcases our unmatched capabilities. In addition to standard offerings, we cater to specialized needs, including products suitable for steam rooms and other bespoke requirements.

Simply provide us with your specifications, and we'll create a bespoke quote and drawing tailored to your exact needs. Your satisfaction is our priority, and we're committed to delivering exceptional service every step of the way.

If the dimensions or configurations in our catalogue don't meet your requirements, don't hesitate to reach out to us and we'll work closely with you to customize a solution that exceeds your expectations. sales@drenchshowers.co.uk





***Crafting Dreams, Not Just products:
our made to measure philoshophy***



Accessories & Parts

At DRENCH, we're committed to ensuring your experience is hassle-free and user-friendly. Every item is meticulously crafted to include all necessary components, guaranteeing optimal performance and seamless installation.

All our products are proudly manufactured in the UK and dispatched from our premises in Hampshire, where we maintain rigorous traceability and quality control standards.

As part of our quality assurance process, we provide photographic documentation of each dispatched item, showcasing all components before final packaging.

We strongly advise checking all deliveries for damages or discrepancies within 48 hours of receipt. Each item is labelled with a unique SO number on both the front and side of the box for easy reference when contacting us for assistance.



This section is dedicated to assisting you with any after-sales issues, from missing components to dimensional discrepancies. Rest assured, our team is here to support you every step of the way, please contact us on sales@drenchshowers.co.uk.

Support Bars & Components

All DRENCH items are supplied with the necessary support bars specified in the item description within this catalogue. For additional support bars, please refer to the individual product listings or contact us at sales@drenchshowers.co.uk.

The table below outlines the compatibility of each support bar with different product configurations.

	Wall Fixed Panels	Wall Fixed Panels with Flipper	Free Standing Panels	Fixed Panel Combination	Single Doors & with Return	Door with Inline	Door hinged to Inline	Shower Enclosures	Bath Screens (Pivot & Fixed)
FXSBCRS Support Bar Access	✓ *For Units > 1000 mm width	✓	✓ *2 x FXSBCRS per panel	✗	✗	✗	✗	✓ *Only for Single Door + Return	✗
FXSBNGL 90° Angle Support Bar	✓ *From 400 to 500 mm width	✗	✗	✗	✗	✓ *For Units < 1000 mm width	✓ *For Units < 1000 mm width	✗	✓ *Optional for Fixed version
FXSBPRL Parallel Support Bar	✗	✗	✗	✗	✗	✓ *For Units > 1000 mm width	✓ *For Units > 1000 mm width	✗	✗
FXSDBDL Return Panel Support Bar	✗	✗	✗	✗	✗	✗	✗	✓ * For Door + Inline + Return	✗
FXSBTBAR T Shape Support Bar	✗	✗	✗	✓	✗	✗	✗	✗	✗

For EDGE Collection Semi-Frameless panels support bars FLS please check page 59.

Extension Profiles

DRENCH products always include the required profiles for installation. These profiles can also be purchased separately for instances where on-site dimensions require adjustments or when multiple panels need to be joined together. Please refer to the adjustment range specified in the catalogue before placing your order.

The adjustment range gives a minimum and a maximum point as per shown on illustration on the right. The adjustment range is basically the room you have to play on site. All panels and shower doors are designed to be used with shower trays so please note our standard mid point will never reach the full shower tray dimension. See illustration below:

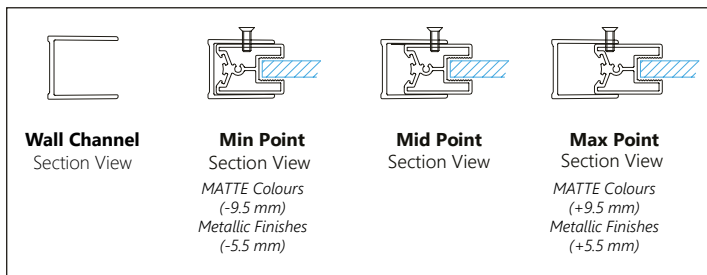

Adjustment range in a recess (1200 mm used as example)

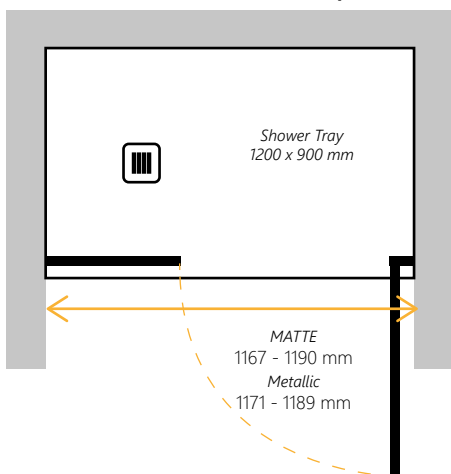

Adjustment range for enclosures (1200 x 900 mm used as example)

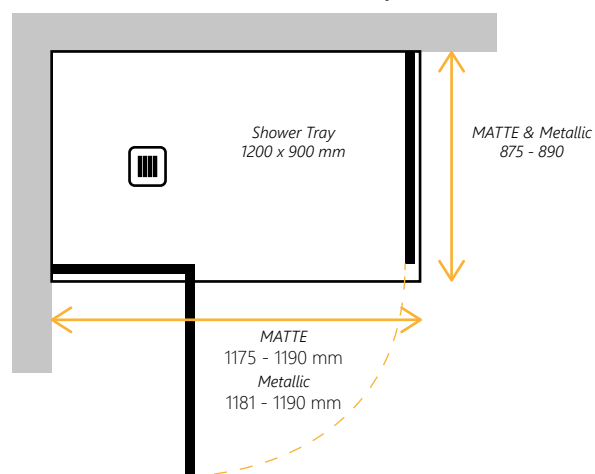

The below list of profiles are helpful when units on site do not fit due to wrong dimensions specified. Please add the 2 digits code for your finish and apply relevant %. Please contact us on sales@drenchshowers.co.uk so we can assist on the issue.

Item Code	Description	Specification	Basic Price EXC Vat
PREXT145..	Extended Wall Channel (+/- 14.5 mm Adjustment) Deeper wall channel to extend shower unit width.		£154
PREXT400..	Extended Wall Channel (+40 mm on width) Box Section to extend shower unit width.		£168
PR758..	Corner Channel Profile to combine for Walk In Shower panels & Shower Enclosures.		£137



Accessories & Parts

Shower Door Seals & Thresholds

To ensure a watertight installation, all DRENCH items come complete with the necessary seals and threshold components. It's essential to follow DRENCH assembly instructions to ensure proper functionality.

In the event of damage or loss during installation, seals and threshold bits are available for individual purchase. For any inquiries or assistance, please don't hesitate to contact us at sales@drenchshowers.co.uk

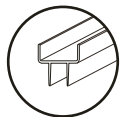

Seals



Item Code	Description	Basic Price EXC Vat
SEALBAT	Rubber Seal for Pivot Bath Screen **PLEASE SPECIFY VISIBLE GLASS BEFORE ORDERING**	£22
SEALFLIP	Rubber Seal for Flipper Panel **PLEASE SPECIFY VISIBLE GLASS BEFORE ORDERING**	£12
SEALDOR	Rubber Seal for Door (Single or paired with Inline panel) **PLEASE SPECIFY VISIBLE GLASS BEFORE ORDERING**	£22

✦ Installing DRENCH seals

Open your door, bath panel or flipper panel fully.

Underneath the bottom profile you should find 2 grooves that go from the closing post to the hinge profile.

Please click the seal into these grooves and make sure the whole piece is clicked in along the profile.

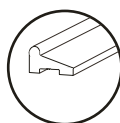
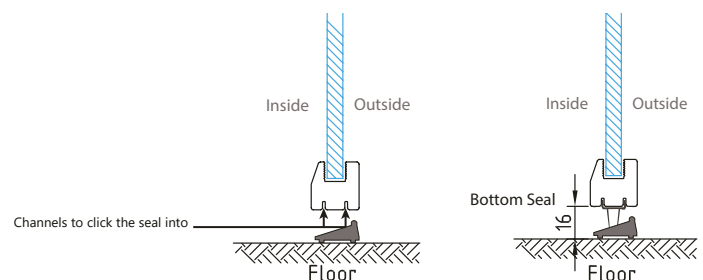

Threshold bit



Item Code	Description	Basic Price EXC Vat
THRL.. THRL..	Threshold for Shower door **PLEASE DOOW WITH AND HANDING (LH or RH) BEFORE ORDERING** Add 2 digits code for the colour/finish of your door	£57

DRENCH shower doors are equipped with threshold bits to prevent water leakage from the shower area. While these bits are included with every door, replacements are available for separate purchase in various colours and finishes to match your shower door. Simply provide the two-digit code for your desired colour/finish when ordering.

For further details or assistance, please contact us at sales@drenchshowers.co.uk.



Maintenance & Cleaning

Profiles & Aluminium Frames

The best method of cleaning is using a **mild detergent solution with warm water**. A sponge or soft cloth should be used and nothing should be harsher than natural bristle brushes.

Glass

There is an **Easy Clean coating** to the internal face of the glass only.

Please be advised that on occasions there may be mist to this face. This can be easily removed with a dry, lint free cloth. For daily cleaning we recommend to use a conventional glass cleaner and a squeegee, especially for the internal side.



We recommend regularly wiping your product with a lint free soft cloth.



You may like to use a squeegee to remove water splash.



Should you wish to use a bathroom cleaner, it should be a mild detergent only and ensure it is rinsed thoroughly with clean water.



Never use any solvents, abrasive cleaners or cloths or anything containing bleach.



Warranty Terms & Conditions

WARRANTY TERMS

DRENCH products have warranty against faulty materials or workmanship. Shower Panels, Doors and Enclosures in Metallic Finishes have lifetime warranty. Shower Trays and Shower Panels, Doors and Enclosures in Matte colours or RAL options have 5 years warranty.

The following rules apply:

- * Proof of purchase in the form a receipt or invoice is required in order to validate the guarantee. In the event that a product is faulty the defect must be notified to our technical department within 30 days of the fault happening. (sales@drenchshowers.co.uk)
- * The product has been purchased in one of our authorised stockist for normal domestic use and it was not purchased as ex-showroom display. The product has not been handled carelessly or misused and has not been wilfully damaged, neglected or used in abnormal conditions. The product has not been modified, altered or transformed in any way.

- * The guarantee will not apply in the event of any repair if DRENCH EUROPE LTD had not been informed accordingly and it was not carried out under DRENCH EUROPE LTD authorisation/supervision. The guarantee will not apply if installation, use and maintenance has not been carried out in accordance with DRENCH EUROPE LTD installation instructions. Damages and breakage of glass are not covered by the guarantee as all glass is used by DRENCH EUROPE LTD conforms to EN12150-1. Fair wear and tear of the product and lime scale and mildew are excluded from the guarantee.
- * Seals, subject to wear and tear are guaranteed only for a period of 12 months. Labour cost are not covered under guarantee unless specifically authorised in writing by DRENCH EUROPE LTD.
- * The benefit of this guarantee cannot be assigned.

- * The guarantee does not cover any further right than those expressed and it does not cover any claim for consequential loss or damage. This guarantee is offered as an extra benefit and does not affect your statutory right as a consumer in any way whatsoever. In the event of a claim under our guarantee, a site visit is required which will be chargeable. This will be refunded in the event that the product is defective or manufactured incorrectly. In the event that DRENCH products are used for Steam or sauna room installations, it must be specified at the point of ordering. Our products in these environments carry a 2 year warranty. In the event that a replacement product is required and the product is not longer available, DRENCH EUROPE LTD will replace it with the nearest available product.

TERMS & CONDITIONS

Definitions

1. "Company" means DRENCH EUROPE LTD.
2. "Customer" means customer of the Company.
3. "Conditions" means the below conditions of sale.
4. "Contract" means any contract entered into for the sale of goods by the Company to the Customer.
5. "Goods" means any Goods the subject of any contract and shall include any part or parts of them and materials incorporated in them.
6. "Standard Items" means any item included in this pricelist with an specific description of size, colour and configuration.
7. "Bespoke" or "Made to measure items" mean any item manufactured as per customer request. items in any specific RAL colour or a Glass option are considered "Bespoke" despite size or configuration.
8. "Carrier" the company person or persons with the object of delivering the Goods to the Customer.

TERMS & CONDITIONS OF SALE:

1. All orders are subject to these Conditions unless otherwise agreed. All goods are subject to availability. If you do not understand any of the following please email us at sales@drenchshowers.co.uk or telephone +44 (0) 2380274945.
2. These Conditions represent the entire Conditions of sale and nothing shall operate to in any way alter or vary the Conditions without the prior approval of DRENCH EUROPE LTD.
3. These conditions shall apply to all contracts to the exclusion of all other conditions express or implied by statute or otherwise to the extent as is permissible by law.
4. Acceptance of Goods by the Customer shall be conclusive evidence before any Court of Arbitrator that these Conditions apply. DRENCH EUROPE LTD reserves the right to change the Conditions without prior notice. Customers are advised to check for any variations to the Conditions before an order.

PRODUCTS:

1. All items sold are brand new products and are supplied complete with full manufacturers guarantee.
2. All items are delivered with fixings and instructions for installation.

3. It is very important that both installation and assembly of DRENCH products are performed by qualified professionals and according to instructions supplied. All images, specifications and advertising on our website are for the sole purpose of giving an approximate description of the goods. We advise customers to seek technical advice from qualified sources prior to ordering including any installation work that may be required.

PRICES:

All prices featured in this pricelist are Recommended Retail Prices excluding VAT. DRENCH EUROPE LTD does not accept liability for any mistake or calculation error made when drawing up a quotation.

ORDERS:

Orders may be placed via distributor, agent, sales representative or directly submitted to our Commercial Department. A written format may be required when placing an order. DRENCH EUROPE LTD do not accept orders via phone or any other means than email. DRENCH EUROPE LTD reserves the right to refuse any order. Orders are accepted on the basis the Customer has read and accepted these conditions.

CANCELLATIONS & MODIFICATIONS:

No order cancellation or modification will be accepted once the manufacturing process has started. In any event, there is a max period of 24 hours after receipt of order confirmation to ask for any cancellation or modification.

To exercise your right of cancellation within 24 hours you must give written notice by email giving details of goods ordered. Orders can only be cancelled once the Company confirms cancellation to the Customer.

DELIVERY:

Please check all deliveries for damages or discrepancies within 48 hours from receiving the goods. Claims for damaged goods must be notified to DRENCH EUROPE LTD by email stating any damages and/or defects of the goods received from the courier. Claims for damaged goods must be notified to DRENCH EUROPE LTD by email stating any damages and/or defects of the goods received from the courier.

Unless we have notification within this period, we have no claim against the courier and therefore we will not be liable for any claim made against our company. Please note that all items must be removed from the packaging and checked within the above time scale.

RETURN POLICY:

Should you wish to return any items to us, the return of the goods must be done subject to the following conditions:

1. The return of Goods will only be admitted when it has been accepted and communicated accordingly by the Company.
2. The return of Goods will only be admitted with the condition as new, in the packaging provided and all components supplied initially.
3. Bespoke and made to measure products as well as RAL colours and Glass Options are non returnable.
4. The Goods must not have been installed or attempted to be installed.
5. Customers are responsible for obtaining proof of delivery and receipt of returned goods. It is the Customer responsibility to ensure the goods reach us in good condition.

RETENTION OF TITLE:

1. The goods shall be at the Buyer's risk as from delivery. 1.2 In spite of delivery having been made, property of the Goods shall not pass from the Seller until:
1.2.1 the buyer shall have paid the Price in full; and
1.2.2 no other sums of any kind shall be due from the buyer to the seller.

PAYMENT CONDITIONS:

Payments can be made by BACS transfer according to sales terms agreed. In the event of outstanding payments, the Company will not dispatch any goods.

DIVISIBILITY CLAUSE:

This contract is divisible. Each delivery made hereunder; 1) shall be deemed to arise from a separate contract and 2) shall be invoiced separately and any invoice for a delivery shall be payable in full accordance with the terms of payments for herein without reference to and notwithstanding any defect of default in delivery of any other instalment.

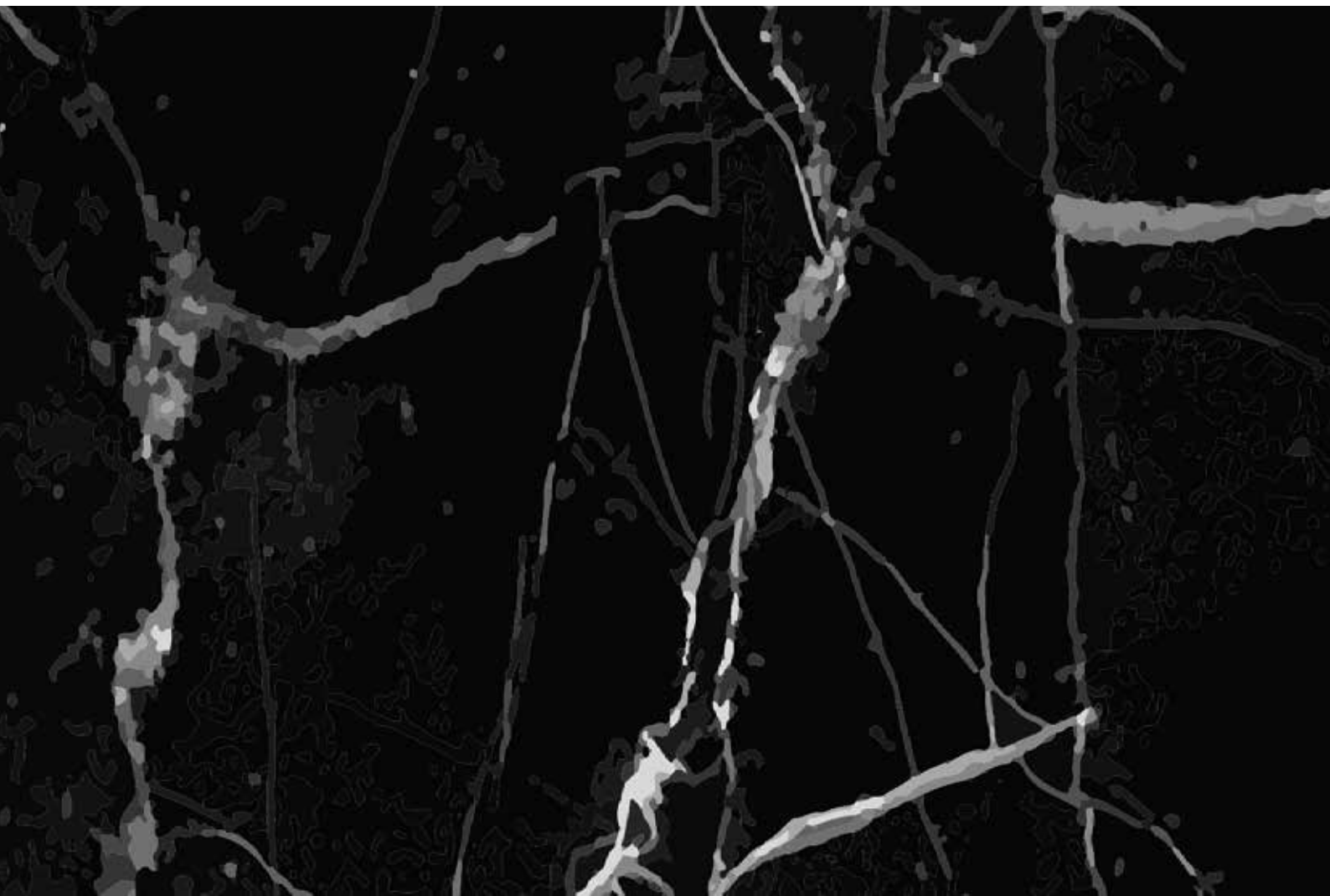

DRENCH

INSPIRE BY DESIGN

Units 5, 6 & 7 Deer Park Farm,
Hursley Road, Hursley, SO21 2LD

sales@drenchshowers.co.uk
+44 (0) 02380 274 945

@drenchshowers

