

INSPIRATIONAL

BATHROOM FURNITURE & SHOWER SPACES



Ab
ambiance bain



*10 years of guarantee on Furniture and 1 year for electrical items, mirrors, WC frames, cisterns, bath panels and ancillary items not manufactured by Ambiance Bain.



Ambiance Bain UK are offsetting our carbon footprint by planting trees. Why not join us on our journey.

Ecologi : <https://ecologi.com/ambiancebain>



This catalogue is available electronically on EQ Pricing and Virtual Worlds CAD design packages. To discover how Partner software can help you with Ambiance Bain product sales and pricing please contact each company directly.

EQ Pricing : 01827 839259
Virtual Worlds : 01908 663848

CONTENTS

THE MODULAR COLLECTION

AVISO	P 8
JOYA.....	P 12
SAXO.....	P 16
PANAME.....	P 20
PROVENÇAL.....	P 24
DOLCE.....	P 28
KETTY.....	P 32
SOLO.....	P 36
DELTA.....	P 38
YOKO.....	P 40
VENUS.....	P 42
BOSS.....	P 44
STAR.....	P 48
TILLI.....	P 52
MAMBO.....	P 54

FITTED COLLECTION P 56

SHOWER SPACES..... P 76

TECHNICAL SPECIFICATIONS..... P 90



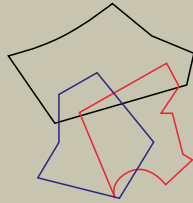

MADE IN
FRANCE

AMBIANCE BAIN

As a French family owned business since 1956, we manufacture inspirational bathroom furniture and shower spaces in our own French artisan factories. Our team of experts work tirelessly each day to create superior quality bathroom furniture and shower spaces without compromise.

66

YEARS OF EXPERIENCE

180

EMPLOYEES

1000

PIECES OF FURNITURE
HAND FINISHED EACH WEEK

2022



1956







MOD ULAR

COLLECTION





AVISO (Dimensions page 93)
 AVISO AVI1402VR double basin unit with SMO273 Pompadour basin and worktop, Matt Silver handgrip. Wall unit AVIH922515, OKA Shower Tray, ELEGANCE Wall Panels in SMO273 Pompadour.



AVISO (Dimensions page 93)

AVISO AVI105L 105cm reduced basin unit, Left Hand with AVICOL2F50 Wall Unit in F89 Cashmere, SMO267 Nougat Satin. Mirrors AVIMI105 width 105 cm.
ELEGANCE PLUS Shower Tray & ELEGANCE Wall Panels in SMO267 Nougat Satin.



AVISO

DESIGNER : C+B LEFEBVRE

10
11



DESIGNER : MATHILDE BRETILLOT

FJORD

JOYA (Dimensions page 94)

JOYA1612 basin unit Colours F65 Fjord, SMO lite™ SMO365 Fjord. ELEGANCE PLUS Shower Tray, ELEGANCE Wall Panels. Colour SMO365 Fjord. MIFORMH Mirror with Shelf 50cm wide.



JOYA (Dimensions page 94)

JOYA2112 double basin unit F35 Burano with 2x JOYALED105 lighting under

SMO267 Nougat Satin double basin and matching made to measure

UNIVERSAL PLUS Shower Tray and ELEGANCE Wall Panels.

JOYAMITBL105 & JOYAMITBR105 illuminated mirrors, 2 x JOYAA3335 tall units.



JOYA

14
15



SAXO (Dimensions page 94)

SAXO1402V SAXO double washbasin unit width 140 cm and tall unit SAXOA3336D. Colours F01 Gloss White, SMO214 Silver Galaxy Gloss. UNIVERSAL PLUS shower tray, ELEGANCE wall panels. Colour SMO214 Silver Galaxy Gloss.



SAXO

16
17



SAXO (Dimensions page 94)

SAXO100 basin unit F51 Sisal SMO200 Gloss White basin with mini upstand & matching made to measure ELEGANCE PLUS Shower Tray & ELEGANCE Wall Panels, SAXOM1100 back-lit mirror and 2 x SAXOA3336R tall units.



1000

SAXO



PANAME (Dimensions page 95)

PANA90T PANAME basin unit with PANADCOL35D low height unit in F65 Fjord, SMO201 Matt white. Mirror MIRADIUS90 width 90 cm. ELEGANCE PLUS Shower Tray, ELEGANCE Wall Panels. Colour SMO201 White Matt.



DESIGNER : ENTRE AUTRE

PANAME

20
21

www.ambiancebain.co.uk



VESUVIO



DESIGNER : ENTRE AUTRE

PANAME (Dimensions page 95)
PANAI75T2V PANAME double washbasin unit width 175 cm and
Tall Unit PANACOL35D. Colours F53 Vesuvio, SMO317 Kaolin Satin.
ELEGANCE PLUS Shower Tray, ELEGANCE wall panel.
Colour SMO317 Kaolin Satin.

PROVENCAL (Dimensions page 95)
PROV602DR 60 cm, 2 Drawer
PROVENCAL Unit in F78 Giverney
with white ceramic basin.
MIFORMH Mirror and PROV3335
PROVENCAL Tall Unit in F78 Giverney.
OKA Portrait Shower Tray and
ELEGANCE Wall Panels in SMO221
Lava.





PROVENÇAL

24
25





PROVENÇAL (Dimensions page 95)
 PROV802DR 80 cm, 2 Drawer
 PROVENÇAL Unit in F88 Cachou
 with white ceramic basin. ALTIMA
 Shower Tray with ALTIMAX Wall
 Panels in SMO315 Ivory satin.

DOLCE (Dimensions page 96)

DOLC600 Double washbasin unit, DOLCA Tall Unit & DOLCAWCWH2066 WC Unit Colours F01 Gloss White, SMO277 Safari. Mirrors MODCURMI. UNIVERSAL PLUS Shower Tray, ELEGANCE Wall Panels and ZSIED seat. Colours SMO277 Safari.





2028

DOLCE



DOLCE (Dimensions page 96)
DOLC500 double basin unit F74 Mistral,
SMO200 Gloss White double basin,
MODCURMIRGB126 RGB multi-coloured
LED lit mirror, DOLCWCWH2066 wall hung
WC unit.

30
31



KETTY (Dimensions page 97)
KETT1201V KETTY 120 cm unit and KETTCOL20L Tall Unit in F35 Burano,
SMO212 Artic Galaxy Gloss. MIFORMH Mirror with Shelf 50cm wide.
OKA Portrait Shower Tray with ELEGANCE Wall Panels in SMO212 Artic Galaxy Gloss.



32
33

KETTY



34
35

KETTY (Dimensions page 97)
KETT1202V Double Basin unit M793 Riga, SMO201 Matt White basin,
MINE120UK mirror, KMNI28179 Niche & KMCOLETMI1793320 Mirror Niche units.



SOLO (Dimensions page 98)
SOLO55 Basin unit F86 Pompadour, SMO200
Gloss White basin, MIDAV56 mirror with LED
lights, KOMBATH170 Bath panel, matching
made to measure airing cupboard doors.



36
37

SOLO



DELTA (Dimensions page 98)
DELTA2001 unit F79 Deauville under
SMO200 Gloss white basin, MIRON75DEP
illuminated mirror,
WCFL2060 WC unit, H8560 wall unit + colour
matched sides, KOMBATH170 Bath panel.



DELTA

38
39





YOKO (Dimensions page 98)
YOKO901 Basin unit F32 Catania, SMO200 Gloss White basin,
MITB55 Mirror.



42
43

VENUS (Dimensions page 99)
VENUS602DPRM Venus 2 Drawer Unit and white ceramic basin with
MODAWCWH2070PU WC unit & 280MAXTALLPM in M441 Santal.
MIFORMR Round Mirror.





BOSS (Dimensions page 100)
Boss BOSS1204DRPM double ceramic washbasin with MODAWCWH2070PU WC unit and KMNI28120 Open Niche in M705 Atoll. SQUARE120 Mirror. ALTIMA Shower Tray and Wall Panels in SMO245 Greige Satin





BOSS

46
47

BOSS (Dimensions page 100)
BOSS602DRPM basin unit F76 Astral, with BOSS 60cm
Ceramic White basin.
SQUARE60 Mirror and KOMBATH170 Matching F76 Astral
Bath Panel.



STAR (Dimensions page 101)

STAR1204DRPM Star unit in M737 Ebony with Staron® R010 Matt White worktop and 2 x VSORONCERNO Black sit on ceramic basins. 280MAXTALLPM Tall unit in M737 Ebony. ELEGANCE PLUS Shower Tray with ELEGANCE Wall Panels in SMO201 Matt White



50
51**STAR** (Dimensions page 101)

STAR1202DRPM Star Basin unit M721 Bosco with Staron® R811 Pebble Ice Solid Surface Worktop, 2 x VSQRECCERBL White Ceramic Sit on Basins, 2 x MITB55 Mirrors, ZBDEC90160 SMO™ Nougat Altima Shower Tray & 4 x ZPDEC24090 Wall Panels.



TILLI (Dimensions page 100)
TILLI601DR Basin unit F35 Burano, MITB55 Mirror & ECCLD Cloud light.

52
53





MAMBO (Dimensions page 102)
MAMBO Basin unit M765 MESSINA, SMO200 Gloss White
basin, MODWCWH2070 WC unit.

FIT

FURNITURE

TIED





FITTED FURNITURE

56
57

family bathrooms

Sleek and curvaceous basin design together with a mixture of unit colours in Olive and Pompadour and matching Pompadour Elegance Plus shower tray and Elegance wall panels.





555
9008





Provence door style, Front F84 Safari with a choice of SMO™, Staron® solid surface or Laminate worktops. P067 Toulon nickel handle.

compact unit
with spacious
washing area



Karla door style, Front F74 Mistral.
Basin, worktop, shower tray and wall panels
SMO234 Blizzard Galaxy Gloss. P070 Crystal
Chrome Handle. Mirror MIRON75DEP.





Karla door style, Front F65 Fjord, basin & worktop SMO200 Gloss White. Carcase inside M529 Silver, MIDAV70UK Star antimist mirror with vertical LED lights.

rounded front
basin unit design



64
65

ENSUITE & SHOWER ROOMS



space saving cut
back units



Provence Country Style Doors, F91 Regal with a choice of SMO™, Staron® solid surface or Laminate worktops. P066 Valence Chrome handle.





Lagoon door style,
Front 410 Gloss White with
P027 Long Crystal Bar Chrome
Handle & Slim Ceramic Basin.
Choice of Staron® or Laminate
worktops.

66
9000

ENSUITE & SHOWER ROOMS

new
inline basin





This slender integrated worktop and washbasin in SMO314 Glacier galaxy satin with 409 Cacao units lends itself beautifully to any small space, providing flexibility of installation options.

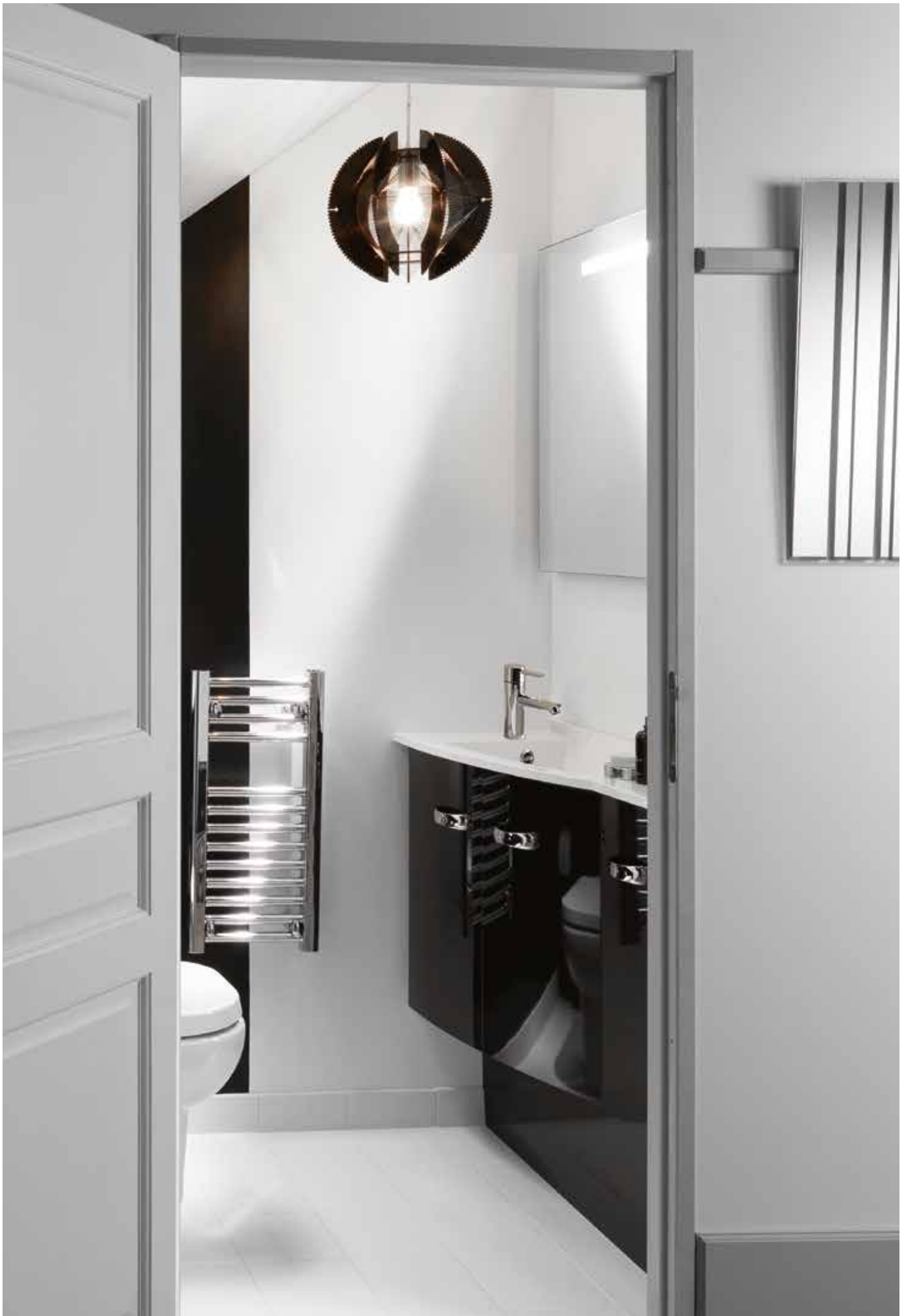

offset basin design



Karla door style, Front F50 Gloss black, basin and worktop SMO200 Gloss white. Handle P048 Sail chrome. Mirror MINE90UK. Reduced depth small offset basin unit with SMO™ worktop and bowl.



reduced depth
unit design



The wall hung WC unit provides cavernous storage capacity while concealing the wall hung WC support frame and cistern. Frames are tested to 60 stones weight.

SHO
SWER

SPACES



76
77



Oka Landscape Shower Tray and ELEGANCE Wall Panels.
Colour SMO273 Pompadour

78
79

OKA Portrait Shower Tray and ELEGANCE Wall Panels.
Colour SMO273 Pompadour



Made to measure ELEGANCE PLUS Shower Tray and ELEGANCE Wall Panels.
Colour SMO365 Fjord.



ELEGANCE PLUS



Made to measure UNIVERSAL PLUS Shower Tray and ELEGANCE Wall Panels. Colour SMO277 Safari.



8328

UNIVERSAL PLUS



ALTIMA Shower Tray and ALTIMAX Wall Panels.
Colour SMO221 Lava satin

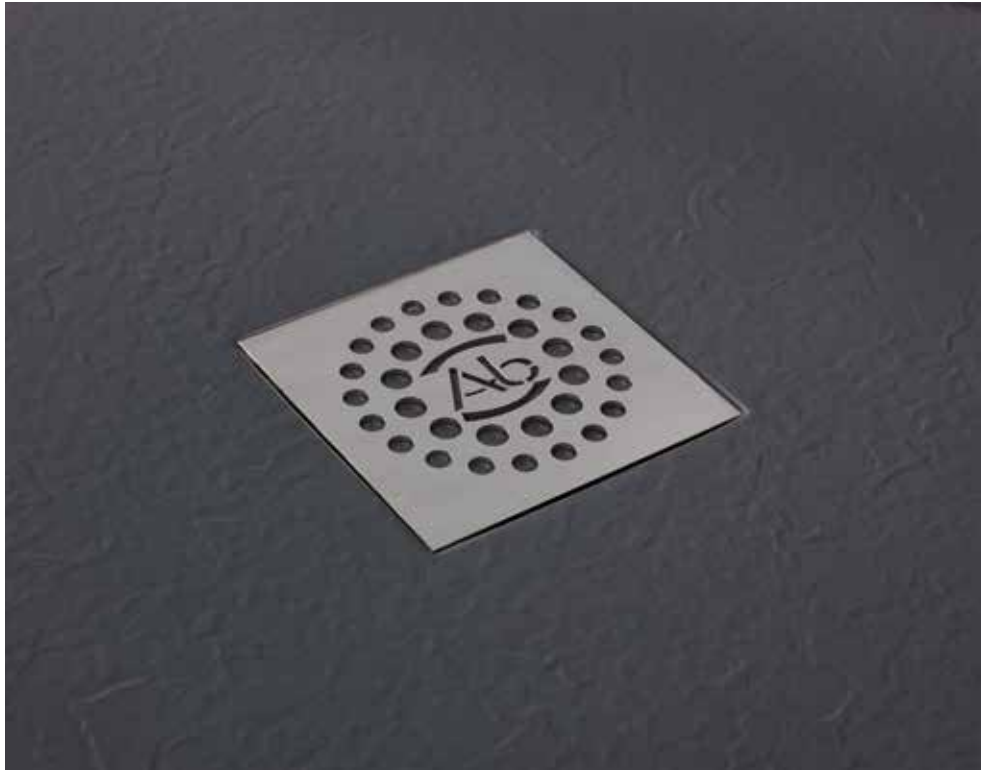

Altima is available in 5 popular colours and various standard sizes from UK stock for rapid delivery. Numerous other colours and sizes available on a longer lead time.

884
885





0800 7106

WALL PANELS & SEATS

AMBIANCE BAIN



Manufacturing inspirational bathroom furniture and shower spaces since 1956

Since the inception of Ambiance Bain, the head office and all the manufacturing facilities have been located in Guilhaumand-Granges, Southern France, a crossroads in the heart of Europe. Our team of professional experts are carefully recruited for their knowledge and skills from within close proximity of the headquarters, allowing a strong regional attachment for all the teams.

...and it's all about the family

Brothers Manuel and Stefan Ghirardello, are now running the company based on the family values inspired by their grandfather Jean Ghirardello. They are constantly modernising the production facilities to prepare the company for the ecological, energy and innovation challenges of the future.

We offer bold and aesthetic design solutions using experience and knowledge to create fabulous, state-of-the-art, functional collections.

The philosophy of our brand is to imagine and produce furniture, shower spaces and aesthetic solutions for optimising space and storage in the bathroom. A value supported by the fundamentals of design: form, colour and material.





Creative freedom thanks to our industrial independence, our creative design team and our innovative production facilities.

For more than 65 years, we have chosen to integrate all the design and production resources necessary for our industrial independence, offering us total freedom in the creation of our beautiful collections.

This independence has allowed us to design and deliver a total aesthetic and functional harmonisation of the bathroom with matching and contrasting bathroom furniture and shower spaces.



From the moment you place your order, we take care of your furniture

Each piece of your bespoke bathroom is made to order, delivered assembled and undergoes stringent quality control with perfect traceability at every step of the way. It is then carefully packaged and shipped.

Innovative technology combined with artisan demands

Digital cutting, laser finishing, nothing is left to chance, the attention to detail is the secret to flawless quality. All the units are assembled following traditional artisan methods with glue and dowels, then individually pressed to ensure their solid longevity.





TECHNICAL SPECIFICATIONS

MOD
ULAR
COLLECTION

MODULAR

90
91

1 CHOOSE A MODULE

Select from our extensive ranges and find the style that suits you best, then choose an individual module according to the available space and your storage requirements. Explore the numerous choices available.

2 SELECT A COLOUR

These fabulous ranges are all available in a beautiful array of the very latest finishes. Be inspired by our assortment of images to select the latest chic interior colour scheme, or completely fulfil your dreams and design your own. All of the available colours are detailed with each range.

3 ADD ANCILLARY UNITS

Add your personal touches by choosing a basin, mirror, tall storage or additional cabinets from those available in the individual range or matching items from our vast array of units from our fitted range to conclude the design of your new oasis.

4 NEED A SHOWER

With a comprehensive range of SMO™ shower trays and wall panels to choose from, Ambiance Bain offer you choice, style and co-ordination with your furniture. Take a look for yourself, there is an option for every style and size of bathroom.

5 FINISHING TOUCHES

Select a bathroom mirror in the same finish as your unit or you can create your own relaxation heaven by selecting remote controlled RGB multi-coloured LED lighting which will add coloured ambient lighting to your room from behind mirrors.





Choice of 3 Handgrip finishes :
Matt Silver, Matt Black or Matt Chrome

The offset options allow more space whilst still offering practical storage

Ultra Functional Interiors

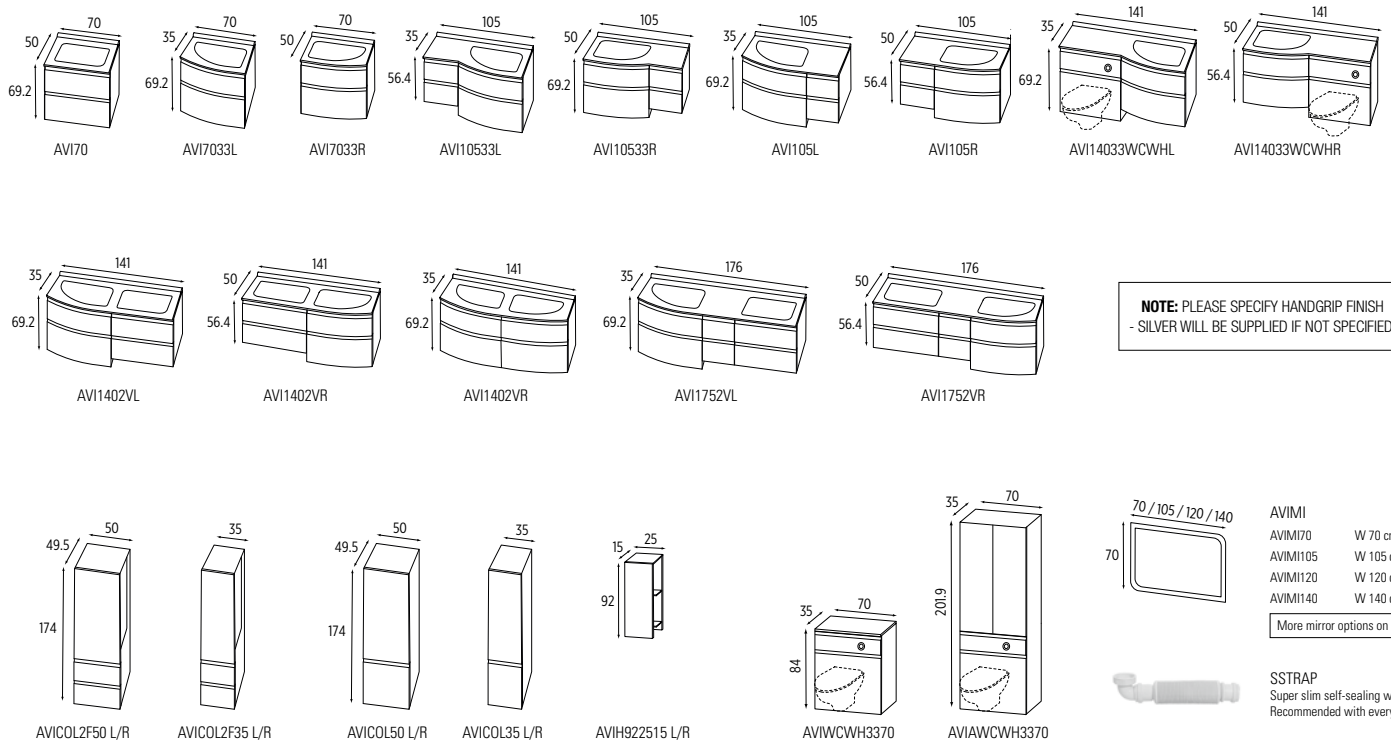

FOIL DOOR COLOURS

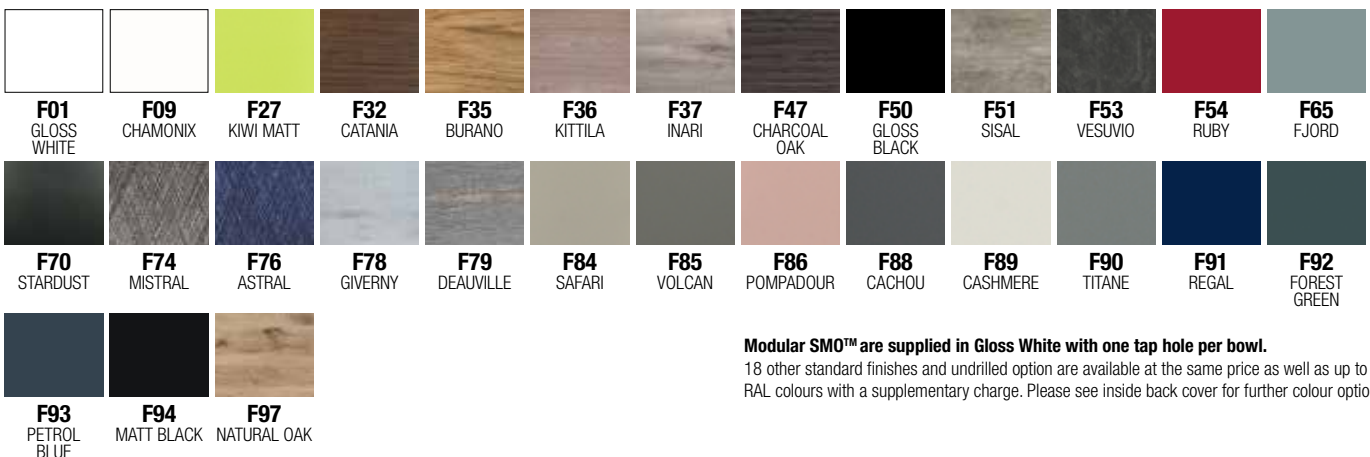

Modular SMO™ are supplied in Gloss White with one tap hole per bowl.

18 other standard finishes and undrilled option are available at the same price as well as up to 200 RAL colours with a supplementary charge. Please see inside back cover for further colour options.

JOYA DESIGNER: MATHILDE BRETILLOT



SMO lite™ Lightweight, Durable Worktop



Matching mirror with shelf



Optional LED Lighting Strip



Premium Drawer box with Glass sides

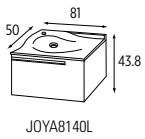

JOYA8140L



JOYA8140R

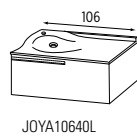

JOYA10640L

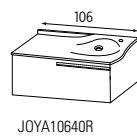

JOYA10640R

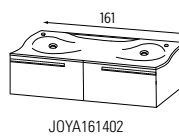

JOYA16140Z

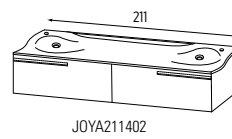

JOYA21140Z

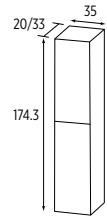

JOYAA20/3335PU L/R
(Push latch opening)

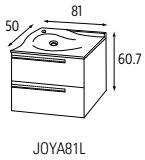

JOYA81L



JOYA81R

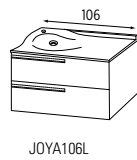

JOYA106L

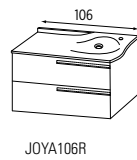

JOYA106R

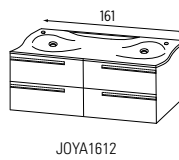

JOYA1612

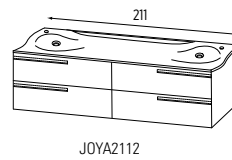

JOYA2112

JOYALED
Optional LED lighting strip
W 81 cm
W 106 cm

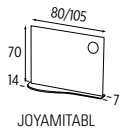

JOYAMITABL

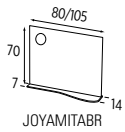

JOYAMITABR

JOYAMITAB L/R
Mirror & Shelf / H 70 cm
W 80 cm
W 105 cm

More mirror options on page 126



SSTRAP
Super slim self-sealing waste/trap
Recommended with every basin

* FOR HANDLESS PUSH LATCH PLEASE ADD SUFFIX **PU**
* FOR MATT BLACK HANDLES ADD SUFFIX **NO**

SAXO



Side grip opening highlighted by a LED strip



Premium metal sided drawer box with removable wooden drawer insert



Matching LED back lit mirror

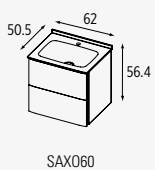

SAXO60



SAXO80

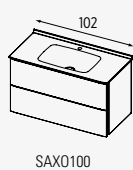

SAXO100

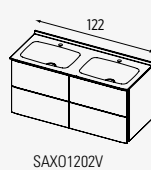

SAXO1202V

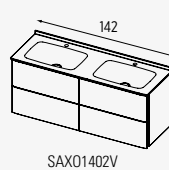

SAXO1402V

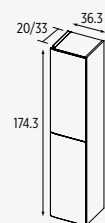

SAXOQA20/3336 L/R

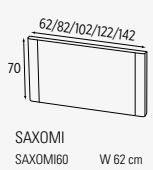

SAXOMI
SAXOMI60 W 62 cm
SAXOMI80 W 82 cm
SAXOMI100 W 102 cm
SAXOMI120 W 122 cm
SAXOMI140 W 142 cm

More mirror options on page 126



SSTRAP
Super slim self-sealing waste/trap
Recommended with every basin

PANAME

DESIGNER: ENTRE AUTRE



Large curved SMO™ basin and worktop, molded in one piece.

Metal grip opening available in 3 colours, Chrome, Matt Black or Copper Plated.



Silver grey sides and interior.

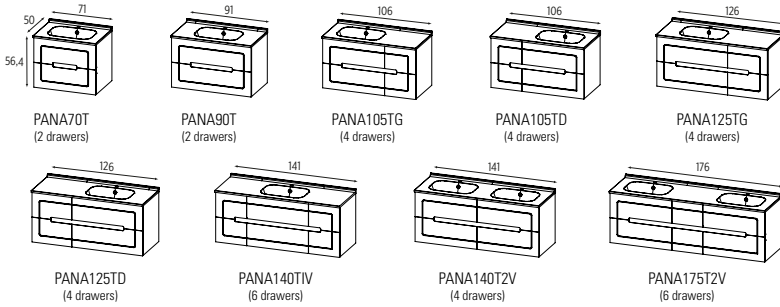

SSTRAP
Super slim self-sealing waste/trap
Recommended with every basin

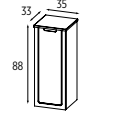
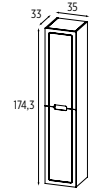

PROVENÇAL



Country style fascias and Grooved end panels.

Short projection ceramic basin

Valence chrome handle

CERAMIC BASIN

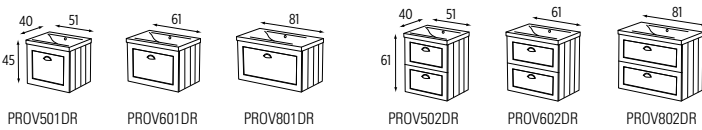

SSTRAP
Super slim self-sealing waste/trap
Recommended with every basin

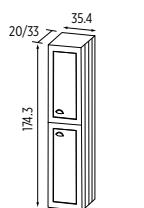
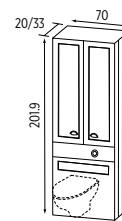
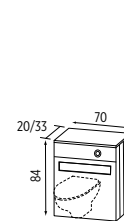

FOIL DOOR COLOURS

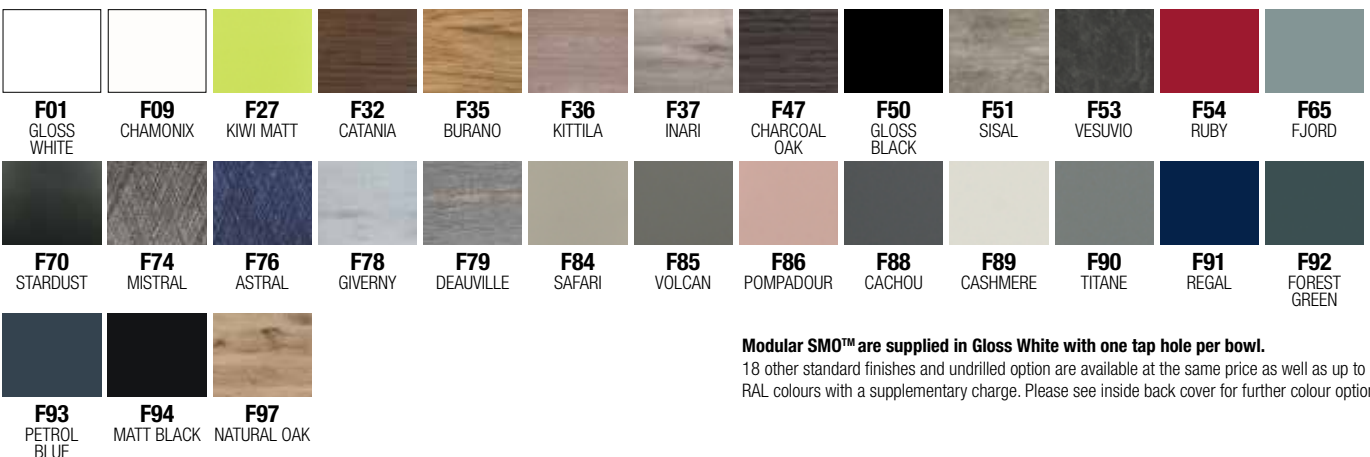

Modular SMO™ are supplied in Gloss White with one tap hole per bowl.

18 other standard finishes and undrilled option are available at the same price as well as up to 200 RAL colours with a supplementary charge. Please see inside back cover for further colour options.

DOLCE



Inset concealed hand grip



The side panels and SMO™ basin create a soft curved unit edge



Premium metal sided drawer box with removable wooden drawer insert

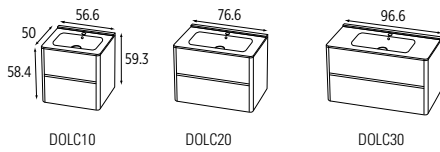

DOLC10

DOLC20

DOLC30

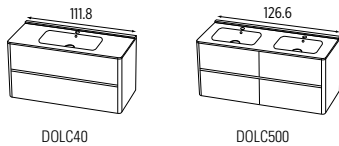

DOLC40

DOLC500



SSTRAP
Super slim self-sealing waste/trap
Recommended with every basin

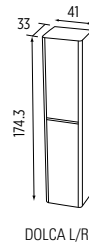

DOLCA L/R

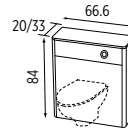

DOLCWCWH20/3366

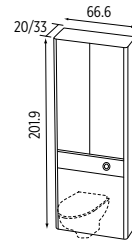

DOLCAWCWH20/3366

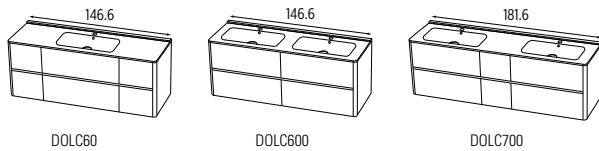

DOLC60

DOLC600

DOLC700

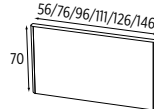

MODCURMI
H 70 cm
MODCURMI56 W 56 cm
MODCURMI76 W 76 cm
MODCURMI96 W 96 cm
MODCURMI111 W 111 cm
MODCURMI126 W 126 cm
MODCURMI146 W 146 cm

MODCURMIRGB
With RGB LEDs, H 70 cm
MODCURMIRGB56 W 56 cm
MODCURMIRGB76 W 76 cm
MODCURMIRGB96 W 96 cm
MODCURMIRGB111 W 111 cm
MODCURMIRGB126 W 126 cm
MODCURMIRGB146 W 146 cm

More mirror options on page 126

FOIL DOOR COLOURS



LAMINATE DOOR COLOURS



Modular SMO™ are supplied in Gloss White with one tap hole per bowl.
18 other standard finishes and undrilled option are available at the same price as well as up to 200 RAL colours with a supplementary charge. Please see inside back cover for further colour options.

KETTY



Add a touch of style and additional support with the optional KITPIED legs



Matching tall & open niche units



Discreet & stylish handgrip

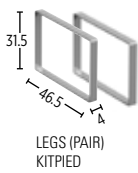
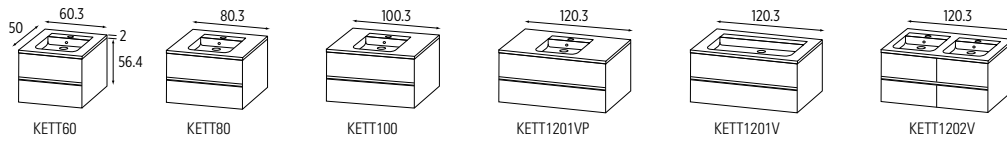

LEGS (PAIR)
KITPIED



SSTRAP
Super slim self-sealing waste/trap
Recommended with every basin

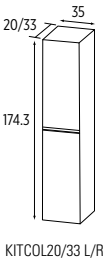

KITCOL20/33 L/R

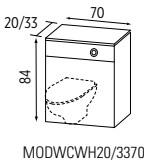

MODWCWH20/3370

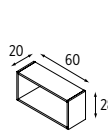

KMNI2860H

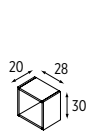

KMNI2830H

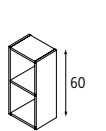

KMNI2860

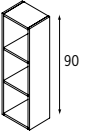

KMNI2890

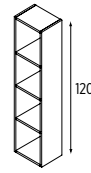

KMNI28120

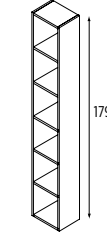

KMNI28179

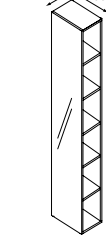

KMCOLETM11793320
Mirror niche

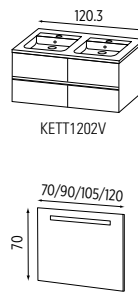

MINEUK
With horizontal frosted strip,
H 70 cm (ANTIMIST)

MINE70UK W 70 cm

MINE90UK W 90 cm

MINE105UK W 105 cm

MINE120UK W 120 cm

More mirror options on page 126

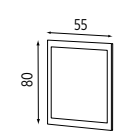

MITB55
W 55 x H 80 cm
Can be horizontal or vertical

More mirror options on page 126

Carcase colours
Side carcase colour visible by the handgrip

For foil fascia colours F01, F09, F78, F81

Carcase M411 Matt white

For foil fascia colours F27, F36, F37, F65, F74, F79, F84

Carcase M529 Silver

For all other foil fascia colours

Carcase M401 Matt black

FOIL DOOR COLOURS



MELAMINE DOOR COLOURS



Modular SMO™ are supplied in Gloss White with one tap hole per bowl.
18 other standard finishes and undrilled option are available at the same price as well as up to 200 RAL colours with a supplementary charge. Please see inside back cover for further colour options.

SOLO



Matching bath panel and made to measure airing cupboard doors

Compact curves - 70 cm unit

Compact curves - 50 cm unit

* FOR HANDLESS PUSH LATCH PLEASE ADD SUFFIX **PU**

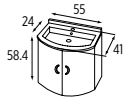

SOLO055*



SOLO070*



SSTRAP
Super slim self-sealing waste/trap
Recommended with every basin

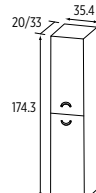

MODA20/3335* L/R

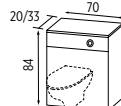

MODWCWH20/3370

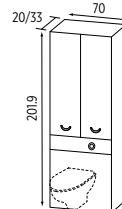

MODAWCWH20/3370*

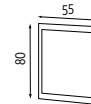

MITB55
W 55 x H 80 cm
Can be horizontal or vertical

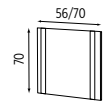

MIDAVUK
With Star LED, H 70 cm (ANTIMIST)
MIDAV56UK W 56 cm
MIDAV70UK W 70 cm

More mirror options on page 126

DELTA



The designer Delta basin slopes delicately into the bowl. Gentle curves are ideal for aesthetics and hygiene.

Both doors are curved in the shape of a wave

Matching tall or low level WC units

* FOR HANDLESS PUSH LATCH PLEASE ADD SUFFIX **PU**

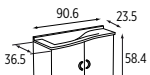

DELTA2001*



DELTA2010*



SSTRAP
Super slim self-sealing waste/trap
Recommended with every basin

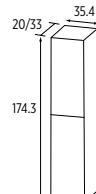

MODA20/3335* L/R

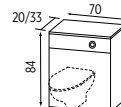

MODWCWH20/3370

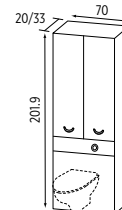

MODAWCWH20/3370*

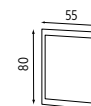

MITB55
W 55 x H 80 cm
Can be horizontal or vertical

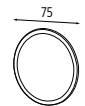

MIROND75 / MIRONDEP75
75 cm Diameter with Antimist, peripheral lighting, touch switch
(Choose with or without etched rim)

More mirror options on page 126

YOKO



Offset Design. Left or Right Hand versions

Ideal for small spaces. Yoko provides an ingenious solution for tight spaces.

Matching mirror

* FOR HANDLESS PUSH LATCH PLEASE ADD SUFFIX **PU**

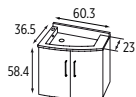

YOK0901*



YOK0910*



SSTRAP
Super slim self-sealing waste/trap
Recommended with every basin

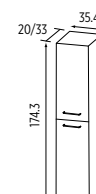

MODA20/3335* L/R

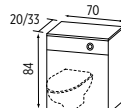

MODWCWH20/3370

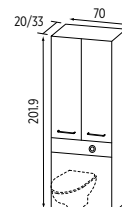

MODAWCWH20/3370*

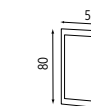

MITB55
W 55 x H 80 cm
Can be horizontal or vertical

More mirror options on page 126

VENUS



Large capacity square ceramic basin



Integrated pull grip opening



Stylish rounded edge units

CERAMIC BASIN

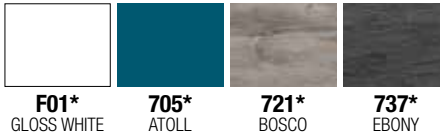

***COLOURS AVAILABLE FROM STOCK**
4 COLOURS OF VENUS BASIN UNITS
AVAILABLE FROM STOCK FOR QUICK DELIVERY

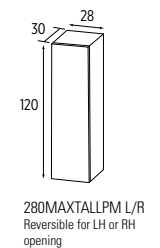
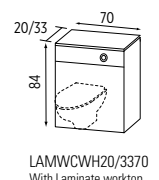
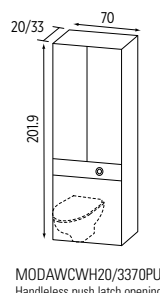
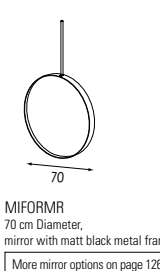
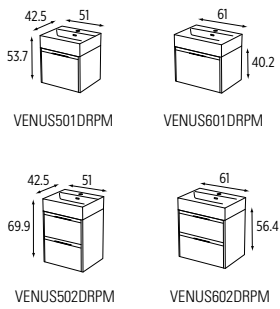

FOIL DOOR COLOURS



LAMINATE DOOR COLOURS



Modular SMO™ are supplied in Gloss White with one tap hole per bowl.

18 other standard finishes and undrilled option are available at the same price as well as up to 200 RAL colours with a supplementary charge. Please see inside back cover for further colour options.

BOSS



Integrated pull grip opening



Soft close BLUM® runners



Large capacity ceramic basin

CERAMIC BASIN

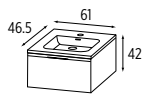

BOSS601DRPM

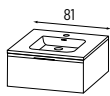

BOSS801DRPM

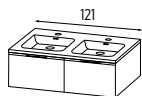

BOSS1202DRPM

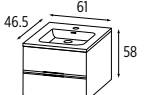

BOSS602DRPM

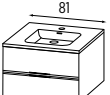

BOSS802DRPM

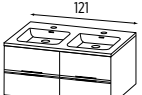

BOSS1204DRPM



SSTRAP
Super slim self-sealing waste/trap
Recommended with every basin

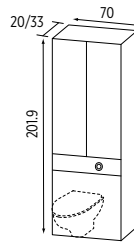

MODAWCWH20/3370PU
Handleless push latch opening

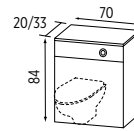

LAMWCWH20/3370
With Laminate worktop

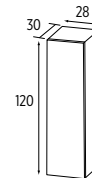

280MAXTALLPM L/R
Reversible for LH or RH opening

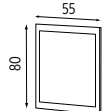

MITB55
W 55 x H 80 cm
Can be horizontal or vertical

More mirror options on page 126

TILLI



Short projection ceramic basin



Depth of only 40cm, perfect solution for small bathrooms with narrow spaces



Compact with storage spaces

CERAMIC BASIN

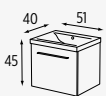

TILLI501DR

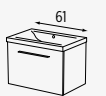

TILLI601DR

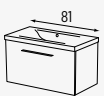

TILLI801DR

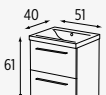

TILLI502DR



TILLI602DR



TILLI802DR

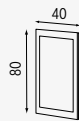

MITB40
W 40 x H 80 cm

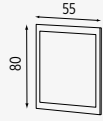

MITB55
W 55 x H 80 cm
Can be horizontal or vertical

More mirror options on page 126



ECCLD40
Cloud LED light Chrome or Black*
W 30 x H 4 cm
* Add **NO** to code for black



ECCLD50
Cloud LED light Chrome or Black*
W 30 x H 5 cm
* Add **NO** to code for black

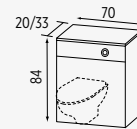

LAMWCWH20/3370
With Laminate worktop

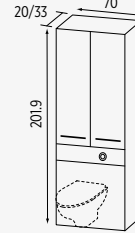

MODAWCWH20/3370

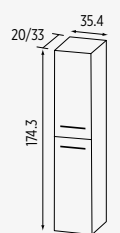

MODA20/3335 L/R

STAR



Sit on oval white & round white or matt black vanity basins



Staron® solid surface worktop



Integrated pull grip opening

STAR601DRPM

STAR801DRPM

STAR1202DRPM

VSQRECCERBL (white)

VSQRONCERBL (white)

VSQRONCERNO (black)

MITB55
W 55 x H 80 cm
Can be horizontal or vertical

SSTRAP
Super slim self-sealing waste/trap
Recommended with every basin

MODAWCWH20/3370PU
Handleless push latch opening

STARWCWH20/3370
With Staron® worktop

280MAXTALLPM L/R
Reversible for LH or RH opening

FFLOW65

FFLOW100

STAR602DRPM

STAR802DRPM

STAR1204DRPM

More mirror options on page 126

FOIL DOOR COLOURS

F01 GLOSS WHITE	F09 CHAMONIX	F27 KIWI MATT	F32 CATANIA	F35 BURANO	F36 KITTILA	F37 INARI
F50 GLOSS BLACK	F51 SISAL	F53 VESUVIO	F54 RUBY	F65 FJORD	F70 STARDUST	F74 MISTRAL
F76 ASTRAL	F78 GIVERNY	F79 DEAUVILLE	F84 SAFARI	F85 VOLCAN	F86 POMPADOUR	F88 CACHOU
F89 CASHMERE	F90 TITANE	F91 REGAL	F92 FOREST GREEN	F93 PETROL BLUE	F94 MATT BLACK	F97 NATURAL OAK

LAMINATE

446 GOLD MARBLE	448 TERRAZZO GREIGE
450 WHITE MARBLE	454 BLACK MARBLE
504 TRAVERTINE	584 OATMEAL
808 GLOSS GREY MIST	814 GLOSS SLATE

MELAMINE DOOR COLOURS

M431 OLIVE	M441 SANTAL	M598 BROWN OAK	M704 CASHMERE
M705 ATOLL	M712 QUERCY	M721 BOSCO	M728 ORME
M730 MATT BLACK	M731 MINT	M733 NEBRASKA	M737 EBONY
M747 CHARCOAL OAK	M765 MESSINA	M793 RIGA	

staron® SOLID SURFACE WORKTOP COLOURS

R010 MATT WHITE	R143 CREMA	R412 SNOW STORM	R420 GRIS	R423 COMET	R440 SAHARA	R811 PEBBLE ICE

F01* GLOSS WHITE	M705* ATOLL	M721* BOSCO	M737* EBONY

*COLOURS AVAILABLE FROM STOCK
4 COLOURS OF BOSS, TILLI & STAR BASIN UNITS
AVAILABLE FROM STOCK FOR QUICK DELIVERY

Staron® worksurfaces are 100% non-porous which makes them highly suitable for bathrooms, where hygiene is of the utmost importance. As it is non-porous, it means that bacteria and moulds are unable to grow on it, or to penetrate the surface.

MAMBO



Hide unsightly plumbing with the floor mounted basin unit



Deep bowl to prevent splashing.



Towel Rail Handle

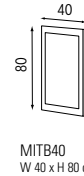
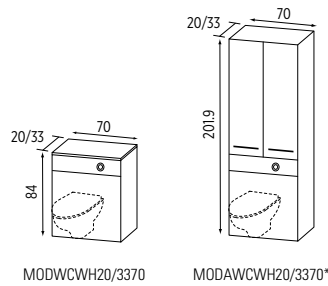
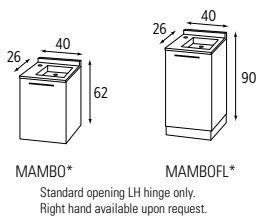

More mirror options on page 126

* FOR HANDLESS PUSH LATCH PLEASE ADD SUFFIX **PU**

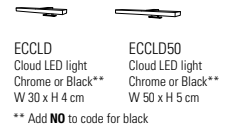

FOIL DOOR COLOURS



MELAMINE DOOR COLOURS



Modular SM0™ are supplied in Gloss White with one tap hole per bowl.
18 other standard finishes and undrilled option are available at the same price as well as up to 200 RAL colours with a supplementary charge. Please see inside back cover for further colour options.

***COLOURS AVAILABLE FROM STOCK**
4 COLOURS OF MAMBO BASIN UNITS
AVAILABLE FROM STOCK FOR QUICK DELIVERY

F01* GLOSS WHITE

M705* ATOLL

M721* BOSCO

M737* EBONY

WHY CHOOSE THE AB MODULAR COLLECTION



1



2



3



4



5



6



7



8



9

1. QUALITY BESPOKE PRODUCTS

All our furniture is delivered fully assembled and manufactured in our own workshops.

2. QUALITY FITTINGS

No matter how often you use them, all our soft close BLUM® hinges and drawer openings are high quality and will stand the test of time.

3. BUILT TO LAST

The high density particleboard panels used in the manufacture of our furniture are among the best quality available on the market.

4. ORIGINAL SHAPES

With complete industrial independence we have a skilled team designing our own original shapes.

5. EASY TO MAINTAIN

The SMO™ washbasins are cast in one seamless piece, including the upstands, making them easy to clean and more hygienic.

6. MAXIMUM STORAGE WITH MATCHING COLOURS

Colour match basin units, WC and wall units offering adaptability to fit in different bathroom configurations, enhancing and maximising storage solutions.

7. COMPLETE CO-ORDINATION

Choose from a wide selection of storage solutions, then add a finishing touch with a matching or co-ordinating mirror and light.

8. THE TOTAL LOOK

The entire bathroom can be colour coordinated. Even your shower tray and wall panels can be the same colour as your furniture, basin and worktop.

9. MATCHING SHOWER SPACE

Complete shower space with matching shower tray & wall panels. Manufactured from SMO™ making it simple to harmonise the colours of the worktop, and shower space.

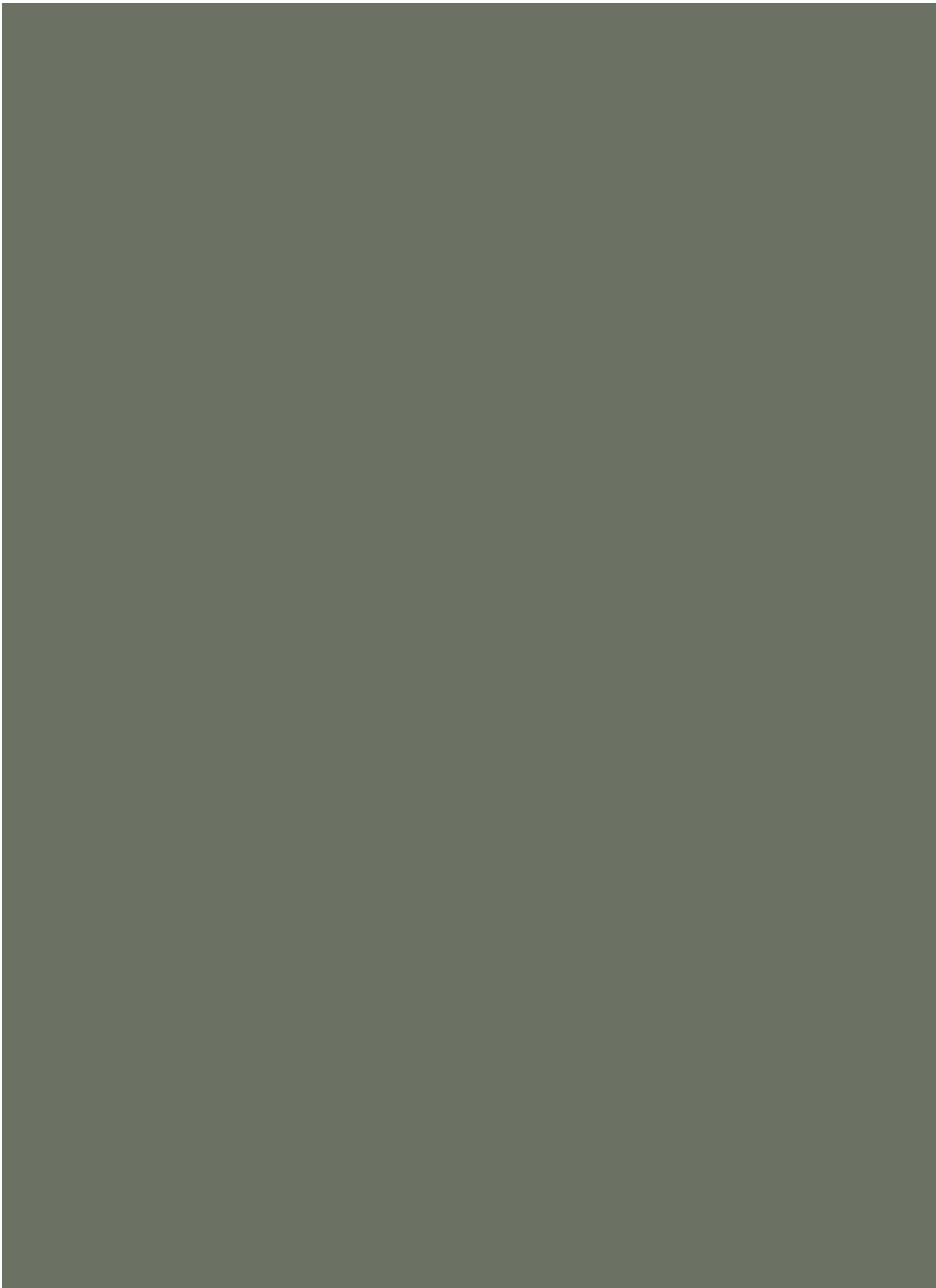

TECHNICAL SPECIFICATIONS

FITTED
FURNITURE
FITTED

FITTED

104
105

WHAT CAN YOU DO WITH FITTED?

Ensuite & Shower Rooms

Choose from the extensive Ambiance Bain range of fitted furniture options to create a stylish and sophisticated ensuite or shower room. Take inspiration from some of the style ideas we have created in an array of different colours to help you design your own personal space.



Family Bathrooms

Maximum storage with matching materials and co-ordinating colours can be used to create the perfect bathroom for all the family. Fun for the kids and a practical oasis for parents.

Cloakrooms & Small Bathrooms

Where space is premium, Ambiance Bain can offer inspirational design options suitable for any size of cloakroom or small bathroom. When you're designing your space, we can offer fantastic space saving ideas to maximise your storage so you can have the beautiful bathroom of your dreams in an array of colours to suit your mood.



1 PLAN YOUR LAYOUT

Draw a plan of your room including doors, windows and existing plumbing then position your units in the available space. Adding large mirrors will enhance the feeling of space in small rooms. Seek inspiration from our catalogue or website and if you need some help, contact your local retailer.

2 SELECT A DOORSTYLE

Whether you are looking for contemporary, classic or country style, Ambiance Bain have an option for you.



3 CHOOSE YOUR WORKTOP MATERIAL

Solid Surface SMO™, Staron® or Laminate, the choice is yours. SMO™ is moulded in a single piece with an integrated basin and is available with or without upstand to help reduce water ingress. StaronR offers a super slim, matt finish to which you can add a ceramic basin of your choice. Laminate is the most affordable option, but is still extremely durable being manufactured from water resistant particle board.



4 HANDLES OR PUSH LATCH

There are many beautiful handles to choose from or if you prefer most of our units are available with a handle-less push latch opening option.

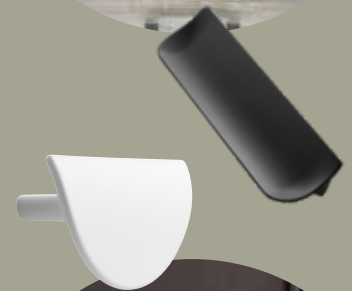

5 NEED A SHOWER ?

With a comprehensive range of adjustable or made to measure SMO™ shower trays and wall panels to choose from, Ambiance Bain offer you choice, style and co-ordination with your worktops and furniture.



4 DESIGN OPTIONS FOR THE SAME BATHROOM



This simple solution hides all plumbing and waste pipework as well as concealing your toilet cistern whilst providing ample worktop space and additional storage. A matching bath panel enhances the design.

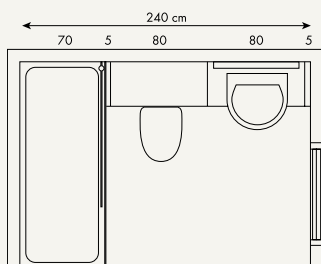

By reducing the WC unit and basin sizes you can add a toilet roll unit with spare roll storage and a large tall unit to house all of your bathroom cosmetics. The addition of a one piece SMO™ basin and worktop combination with moulded upstand creates an easy clean seamless solution.

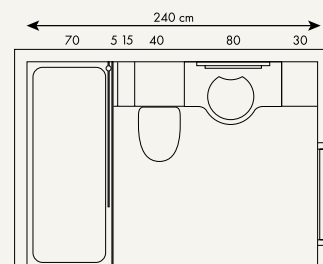

From a simple design to hide all unsightly pipework to a sculpted designer layout which maximises the storage possibilities, and from co-ordinating decorative mirrors to large panoramic versions with illuminated LED lighting pelmets the options are endless. Ambiance Bain have numerous door styles and colour options to choose from.

See the back of the brochure to choose the hues and tones that suit your taste. Your local Ambiance Bain specialist has vast experience in designing both beautiful and practical bathrooms and will be more than happy to help you create your own individual design within your own personal budget.



Introducing an offset curved basin unit with designer shaped bowl adds to the opulence and storage capacity, whilst the large panoramic mirrors and illuminated LED lighting pelmet increase the feeling of light and space within the room.

Adding a tall WC unit brings a different feel but adds cavernous storage above the toilet. Combined with the large offset basin unit there is copious amounts of space to accommodate your health care and toiletry products.

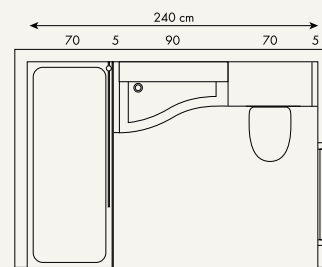
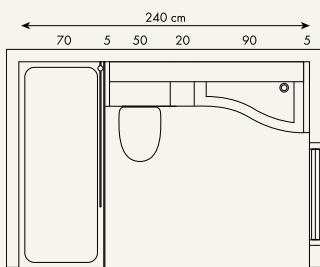

ENSUITE & SHOWER ROOM

SAVE SPACE WITH CUT BACK UNITS

Country style doors with a choice of SMO™, Staron® or Laminate Worktops.

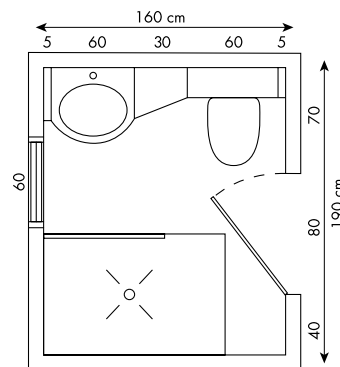

INSPIRATION PAGE 66

1. Wall units
2. New Semi Recessed SMO™ worktop and basin
3. Provence Country style doors
4. Cut back unit adds space in your bathroom
5. SMO™ Splash back
6. Tongue & groove detailing on end panels
7. Laminate worktop
8. Staron® solid surface worktop



PROVENCE DOOR STYLE



VALENCE

chrome handle
see page 127 for full options.



AVAILABLE COLOURS
see page 128-130

ENSUITE & SHOWER ROOM

SHORT PROJECTION BASIN & UNIT

Slim ceramic basin and unit with just a 40cm projection. Ideal for small bathrooms.

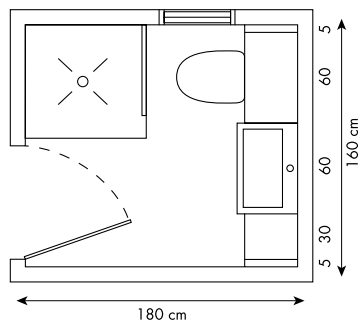

INSPIRATION PAGE 68

1. Round mirror with peripheral LED lighting & optional etched border
2. Slim ceramic basin and unit with 40cm projection
3. Co-ordinating SMO™ shower tray & wall panels
4. Laminate worktop
5. Staron® solid surface worktop

LAGOON DOOR STYLE



LONG CRYSTAL BAR

chrome handle
see page 127 for full options.



AVAILABLE COLOURS
see page 128-130

ENSUITE & SHOWER ROOM

ROUNDED FRONT BASIN UNIT DESIGN

With a choice of 55 or 70cm wide curved basin and reduced depth unit to maximise space.

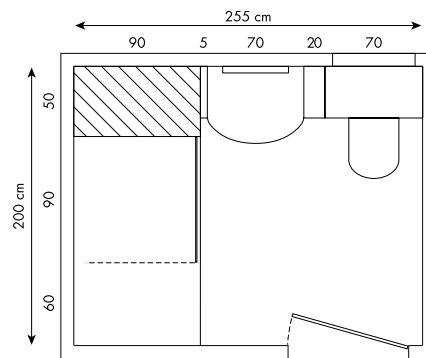

INSPIRATION PAGE 64

1. Mirror fitted with 2 LED lighting strips on either side.
2. Discreet toilet roll unit.
3. Reduced Depth Basin 70cm
4. Reduced Depth Basin 55cm
5. Window sill in matching SMOTM material.
6. Mini upstand prevents water infiltration.
7. Handleless push-latch opening design.

KARLA DOOR STYLE



HANDLE-LESS PUSH-LATCH OPENING DESIGN



AVAILABLE COLOURS
see page 128-130



ENSUITE & SHOWER ROOM

90CM OFFSET BASIN UNIT WITH MINI UPSTAND

Compact unit with spacious washing area, the worktop flows into the basin for a hygienic and stylish look.

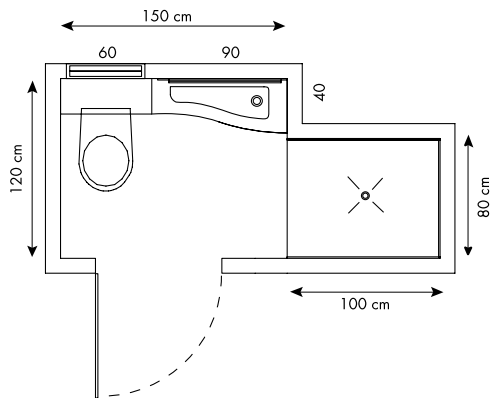

INSPIRATION PAGE 62

1. Reduced depth 90cm offset basin unit
2. matching SMO™ window sill
3. matching SMO™ shower tray & shower wall panels
4. SMO™ worktop, mini upstand and dedicated bowl

KARLA DOOR STYLE



CRYSTAL

chrome handle
see page 127 for full options.



AVAILABLE COLOURS

see page 128-130



FAMILY BATHROOMS

EXTRA DEEP SQUARE OR OVAL BASIN DESIGN

Full depth units are available with extra deep 50 or 60cm worktops adding practical worktop space & large washbasins.

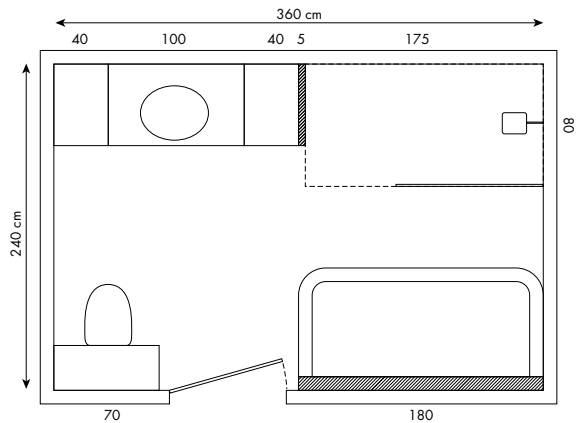

1. Super storage for all the family's toiletries
2. Practical worktop space
3. Square Bowl Design
4. Oval bowl design
5. Matching SMO™ bath tap ledge
6. Matching SMO™ worktop

PURA DOOR STYLE



INTEGRATED CHROME TRIM HANDLE



AVAILABLE COLOURS
see page 128-130

FAMILY BATHROOMS

CURVED OFFSET BASIN & UNIT

Offset basin with 30cm rounded end unit and special curved plinth aesthetically pleasing whilst maximising storage.

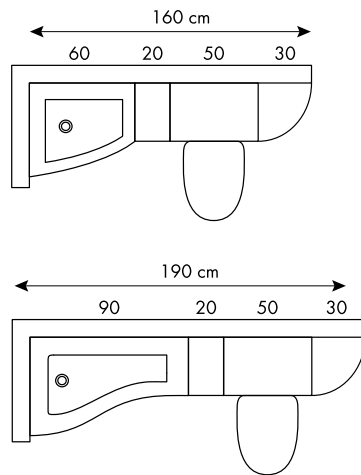

1. 30cm rounded end unit and special curved plinth.
2. The pull-out unit features 2 storage baskets.
3. 60cm offset basin and unit.
4. 90 cm offset basin and unit.



LAGOON DOOR STYLE



CRYSTAL
chrome handle
see page 127 for full options.



AVAILABLE COLOURS
see page 128-130

FAMILY BATHROOMS

SPACE SAVING TOILET DESIGN

Compact 40cm toilet unit, special airing cupboard doors and matching bath panel for a complete, co-ordinated solution.

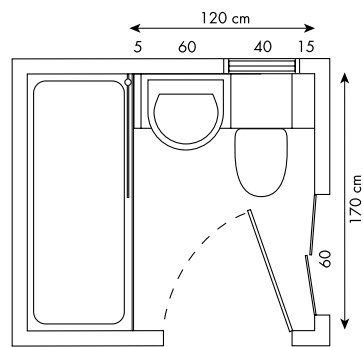

1. Co-ordinating bath panel
2. Compact 40cm toilet unit, same size as a toilet pan
3. Lift up storage for spare loo rolls and sanitary items
4. Special airing cupboard doors
5. The bath filler unit is specifically designed to butt a run of furniture against the bath and prevent water infiltration



NATIVE DOOR STYLE



RETRO

chrome handle
see page 127 for full options.



AVAILABLE COLOURS
see page 128-130

FAMILY BATHROOMS



HI LINE MULTIPLE DRAWER DESIGN

Large storage capacity with numerous drawers which can be opened to their full depth.

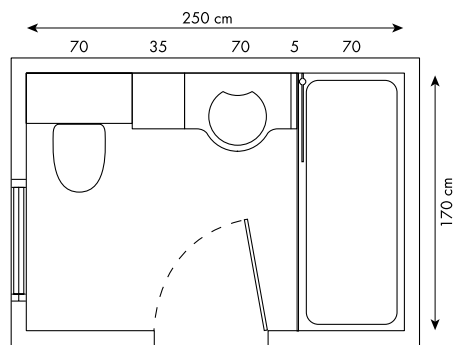

1. Matching basin worktop and wall panelling
2. Large storage capacity. The numerous drawers can be opened to their full depth and are easy to reach, providing unmatched storage capacity



KARLA DOOR STYLE



BENT BAR

chrome handle
see page 127 for full options.



AVAILABLE COLOURS
see page 128-130

FAMILY BATHROOMS

COUNTRY STYLING WITH A CHOICE OF WORKTOPS

Use a curved end unit to allow more door opening space, then choose from a cost effective laminate or more durable solid surface worktop.

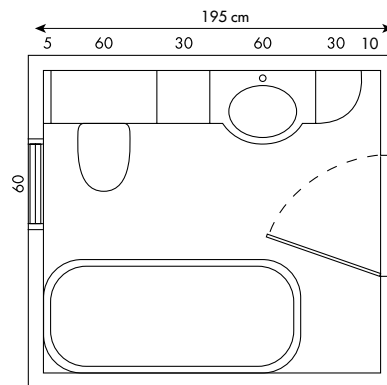

INSPIRATION PAGE 60

1. Round mirror with peripheral LED lighting & optional etched rim
2. Provence Country style doors
3. Curved end unit allows for door opening in tight spaces
4. SMO™ moulded worktop and basin
5. Staron® solid surface worktop
6. Laminate worktop



PROVENCE DOOR STYLE



TOULON

chrome handle
see page 127 for full options.



AVAILABLE COLOURS

see page 128-130

FAMILY BATHROOMS



L SHAPED DESIGN WITH EXTRA CORNER STORAGE

Laminate worktops featuring curved ends and cut backs with waterproof upstands provide an affordable solution when combined with a ceramic semi-countertop basin.

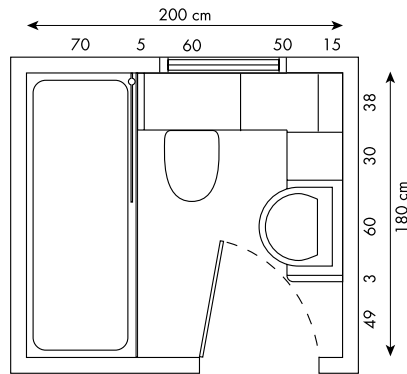

1. Pre-prepared factory worktop joint
2. Corner unit utilises corner void space for extra storage
3. Laminate worktops
4. Optional softly curved end panel creates a striking design whilst softening units end

LAGOON DOOR STYLE



LONG CRYSTAL BAR

chrome handle
see page 127 for full options.



AVAILABLE COLOURS
see page 128-130

FAMILY BATHROOMS

SIMPLE, STYLISH, ONE PIECE SEMI RECESSED BASIN & WORKTOP

Compact units with ample washing space and lots of hidden storage. The SMO™ worktop and basin is moulded in a single piece for a hygienic finish.

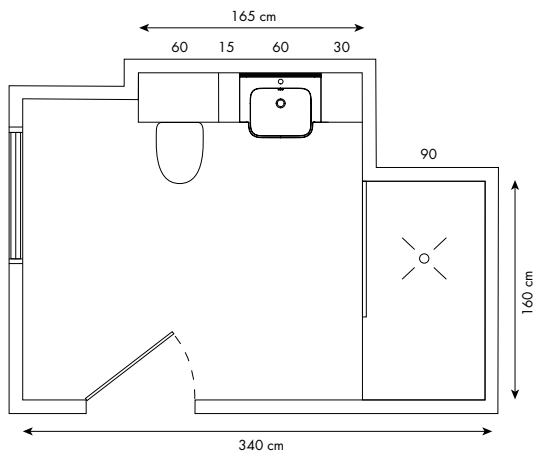

INSPIRATION PAGE 58

1. Stylsh semi-recessed basin
2. Integrated toilet roll holder & storage
3. Basin unit with double doors
4. Matching shower tray and wall panels
5. Easy to clean moulded basin and worktop
6. Wall hung WC unit complete with wall frame and cistern

KARLA DOOR STYLE



RIDGE

chrome handle
see page 127 for full options.



AVAILABLE COLOURS
see page 128-130



CLOAKROOMS & SMALL BATHROOMS



PRACTICAL STORAGE IDEAL FOR SMALL SPACES

The inline basin with integrated worktop fits neatly into any bathroom, but is particularly suitable for bathrooms with limited space. The mini basin upstand helps prevent splashing.

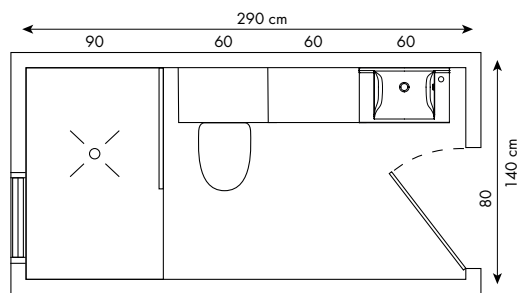

INSPIRATION PAGE 70

1. Compact 60cm wide basin drawer unit
2. Tall WC unit including Geberit fixing frame & cistern
3. Altima Shower Tray with Altimax Wall Panels
4. Colour match sides
5. Hygienic, single piece SMO™ Inline basin and worktop



KARLA DOOR STYLE



SUMIKO

chrome handle
see page 127 for full options.



AVAILABLE COLOURS

see page 128-130

CLOAKROOMS & SMALL BATHROOMS

OFFSET BASIN DESIGN

Reduced depth units to fit in even the smallest rooms.



INSPIRATION PAGE 72

1. Reduced depth units will fit into the smallest of cloakrooms.
2. SMO™ Moulded one piece basin and worktop creates larger bowl.

SAIL

chrome handle
see page 127 for full options.

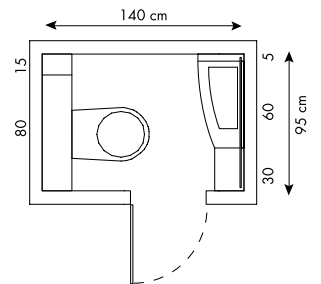

REDUCED DEPTH UNIT DESIGN

New semi recessed SMO™ basin & worktop with large bowl and 40cm projection units.



INSPIRATION PAGE 74

1. Matching filler panels
2. Matching mirror
3. Matching unit carcass
4. Moulded upstand protects the wall and removes the need for silicon seal
5. Large bowl with limited 40cm projection
6. Small double door unit opens fully without impacting toilet

RIDGE

chrome handle
see page 127 for full options.

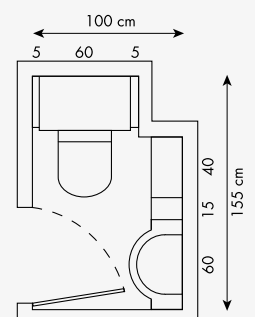

WHY CHOOSE AB FITTED FURNITURE



1



2



3



4



5



6



7



8



9

1. MIRROR

Secured by aluminium rails for increased safety and easier installation. 6mm thick to add depth, brightness, and reflection without distortion. Available with optional heated antimist pads.

4. CARCASES

Manufactured with solid backs in high-density melamine (650kg/m³) and meets EN312 standard. Available in numerous colours to co-ordinate with your fascias.

7. ANTIMIST

Many of our mirrors come complete with or may be fitted with our ANTIMIST heated pads. These prevent an area of your mirror from steaming up with condensation in your bathroom.

2. LIGHTING PELMET

Fitted with concealed transformer, drivers and wiring to support built-in natural white (4100K) LED low voltage spotlights. With Class II electric shock protection.

5. DRAWERS

Open fully for easy access and feature easy to clean rounded inside edges. Dynamic load: 30kg (no sagging). Smooth gliding for guaranteed comfort. Blumatic soft-close action. Three-way adjustable, quick clip-on fittings for perfect fascia alignment.

8. HINGES

Clip-on for easy installation. Soft close dampers, 110° opening and 3 way adjustable for better accessibility.

3. CONCEALED CISTERNS AND WALL HUNG TOILET FRAMES

Every WC unit comes complete with a GEBERIT dual flush push button cistern (Macdee cistern in 40cm WC unit). All cistern components are accessible and replaceable through the removable top fascia panel. Wall hung toilet units include a GEBERIT super strong steel frame (tested to over 400kg/60 stones) with multiple fixing points to support the toilet.

6. WATER-RESISTANT WORKTOPS

Ambiance Bain offer 3 types of worktops. SMO™ and Staron® solid surface or laminate, the choice is yours.

9. MIRRORED SHELVING UNITS

Fitted with mirrored back, these are durable, UV-bonded 10mm glass shelves that add a sleek touch to your bathroom.

FINISHING TOUCHES



LAGOON door style 814, SM0218 basin & worktop.

At Ambiance Bain we can even supply our many manufacturing materials so that your installer can finish your bathroom to that perfect level and with great detail.



1. MADE TO MEASURE SPECIAL DOORS

Many standard sizes or even made-to-measure doors and panels are available to match your furniture and conceal your airing cupboard, boiler or any other space.

Ask your Ambiance Bain specialist for more details.

FINISHING TOUCHES



2.

LAMINATE SHELVES

18mm thick laminated shelves can be used to create window sills, dwarf wall cappings and bath decks.

TOPS 1/2 round edged 18mm shelving
(10 - 40cm deep)

SMO™ SHELVES

20mm thick SMO™ shelves can be used to create window sills, dwarf wall cappings and bath decks.

ZTAB23 23.5 cm deep
ZTAB36 36.5 cm deep
ZTAB50 50.0 cm deep
ZTAB60 60.0 cm deep

staron® SOLID SURFACE

12mm Staron® countertops are non-porous and hygienic. Ideal for window sills, and other finishing touches.

STARTAB23 23.5 cm deep
STARTAB36 35.5 cm deep
STARTAB50 50.0 cm deep
STARTAB60 59.0 cm deep

3. MADE TO MEASURE PANELS

Complementary panels of fully edged melamine or laminated and foil wrapped boards can be supplied to box in unsightly plumbing, soil pipes or other services

PAMEL16 Melamine board
PASTR1 Laminated or foil wrapped board



4. BATH PANELS

Bath panels are available in various sizes, styles and all colours and finishes to blend beautifully with your bathroom furniture. The plinth and panel are adjustable from behind to allow installation to standard bath heights up to 58cm. For unusually high baths an additional higher plinth can be supplied to increase the height by up to 12cm.

STANDARD BATH PANEL With adjustable plinth (58 cm maximum height)
PROVENCE BATH PANEL With adjustable plinth (58 cm maximum height)
HIGH BATH PANEL with adjustable plinth (68cm maximum height)



TO VIEW FURTHER DETAILS
 VISIT OUR WEBSITE
WWW.AMBIANCEBAIN.CO.UK/FINISHING-TOUCHES



MIRRORS



LED-LIT MIRRORS
H 45 cm
(Can be fitted vertically or horizontally)

MILDH45UK : W 45 cm
MILDH70UK : W 70 cm
MILDH90UK : W 90 cm
MILDH105UK : W 105 cm
MILDH120UK : W 120 cm
MILDH140UK : W 140 cm



OVAL LED MIRROR
H 70 cm (Can be fitted vertically or horizontally)
MIRADIUS90 : W 90 cm



ROUND PERIPHERAL LED LIT MIRROR
D 75 cm
MIROND75 : round mirror plain
MIRONDEP75 : round mirror etched border



ESQUIRE LED ILLUMINATED MIRROR
H 55 cm
SQUARE60 : W 60 cm
SQUARE90 : W 90 cm
SQUARE120 : W 120 cm



RECTANGULAR MIRROR WITH MATT BLACK METAL FRAME
Rectangular with shelf W 31.5 cm Prof. 10 cm.
(Delivered with removable telescopic tube
Diameter 16mm Length max 55cm, min 35cm)

MIFORMH : W 50 cm, H 100 cm



ROUND MIRROR WITH MATT BLACK METAL FRAME
D 70 cm
(Delivered with removable telescopic tube
Diameter 16mm Length max 55cm, min 35cm)

MIFORMR : W 70 cm



MOOD MIRROR
H 80 cm (Can be fitted vertically or horizontally)
MITB40 : W 40 cm
MITB55 : W 55 cm



MODULAR HANDLES



Each modular unit includes the specified handles. For alternative, spare & modular handles on fitted units, order undrilled and choose from the chargeable handles below.



TILLI/MAMBO
PO36 : L 33.2 cm



JOYA
PO79 : L 65 cm
For Matt Black Joya Handles add suffix **NO**

FITTED HANDLES

Each Fitted unit includes Fitted handles. The position shown is indicative, but may be different according to the door style or units chosen. Check with the sales office for exact orientation of handles on each unit or order undrilled and fix to clients specification during installation.



P039
WAVE
CHROME



P067
TOULON
NICKEL



P068
RETRO
CHROME



P070
CRYSTAL
CHROME



P037
LUNA CHROME
(HORIZONTAL)



P048
SAIL CHROME
(HORIZONTAL)



P066
VALENCE
CHROME



P053
BENT BAR
CHROME
(HORIZONTAL)



P055
RIDGE
(HORIZONTAL)



P271
SUMIKO
CHROME
(HORIZONTAL)



P273
SUMIKO
MATT BLACK
(HORIZONTAL)



P275
SUMIKO
MATT GOLD
(HORIZONTAL)



P035
LOOP
CHROME
(HORIZONTAL)



P027
LONG CRYSTAL
BAR CHROME
(HORIZONTAL)



P195
SLOPE
MATT BLACK
(HORIZONTAL)



P197
HORIZON SMALL
MATT WHITE
(HORIZONTAL)



P198
HORIZON SMALL
MATT BLACK
(HORIZONTAL)

FOIL DOOR COLOURS



KARLA
Price group 1
SQUARE EDGE



PROVENCE
Price Group 2
COUNTRY STYLE



PURA
Price group 3
INTEGRATED CHROME HANDLE

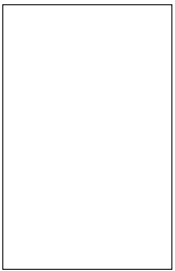

F01
GLOSS WHITE



F09
CHAMONIX

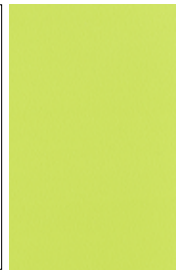

F27
KIWI MATT



F32
CATANIA



F35
BURANO



F36
KITTILA



F37
INARI

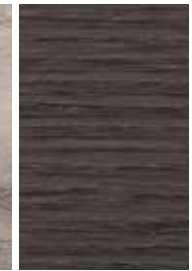

F47
CHARCOAL OAK

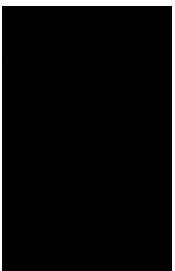

F50
GLOSS BLACK



F51
SISAL



F53
VESUVIO



F54
RUBY



F65
FJORD

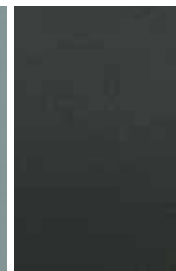

F70
STARDUST



F74
MISTRAL



F76
ASTRAL



F78
GIVERNY



F79
DEAUVILLE



F84
SAFARI

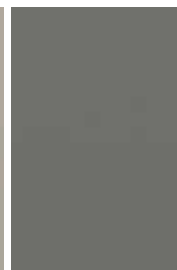

F85
VOLCAN



F86
POMPADOUR

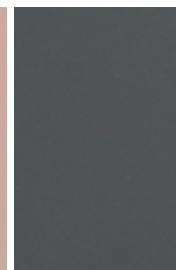

F88
CACHOU

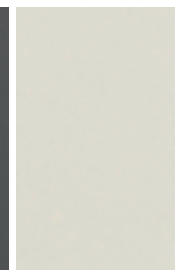

F89
CASHMERE



F90
TITANE



F91
REGAL



F92
FOREST GREEN

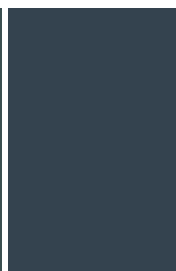

F93
PETROL BLUE



F94
MATT BLACK



F97
NATURAL OAK

MELAMINE DOOR & CARCASE COLOURS



NATIVE

Price group 0
SQUARE EDGE



M410
GLOSS WHITE

M411 (CARCASE ONLY)
MATT WHITE

M431
OLIVE

M441
SANTAL

M529 (CARCASE ONLY)
SILVER

M598
BROWN OAK

M704
CASHMERE

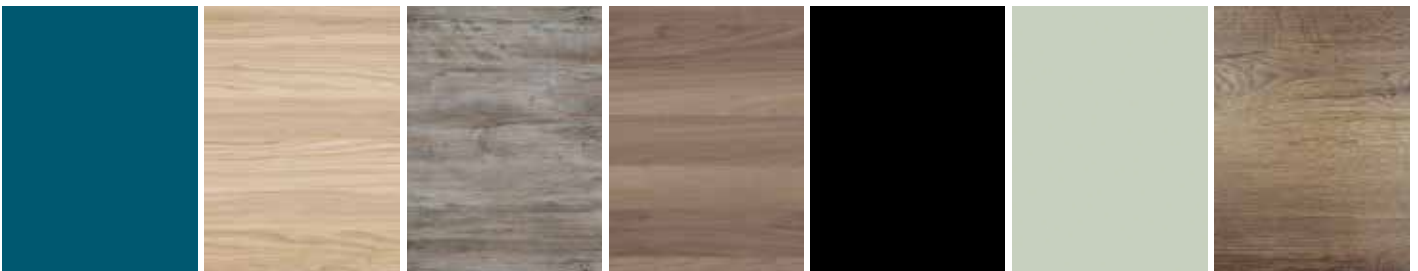

M705
ATOLL

M712
QUERCY

M721
BOSCO

M728
ORME

M730
MATT BLACK

M731
MINT

M733
NEBRASKA



M737
EBONY

M747
CHARCOAL OAK

M765
MESSINA

M771 (CARCASE ONLY)
URBAN

M793
RIGA

LAMINATE DOOR & WORKTOP COLOURS



LAGOON

Price group 1

SQUARE EDGE



410
GLOSS WHITE



430
GLOSS BLACK



431
OLIVE

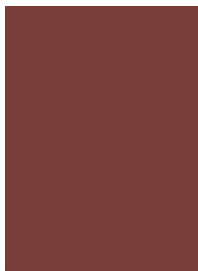

441
SANTAL



446
GOLD MARBLE



448
TERRAZZO GREIGE



450
WHITE MARBLE



454
BLACK MARBLE



504
TRAVERTINE

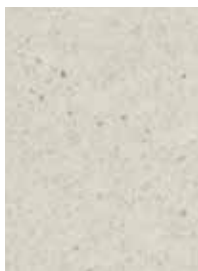

584
OATMEAL



705
ATOLL



721
BOSCO



737
EBONY



765
MESSINA



793
RIGA

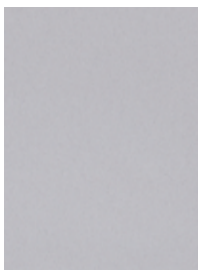

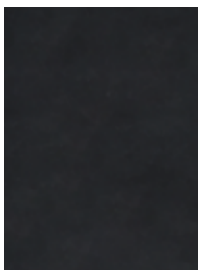

808
GLOSS GREY
MIST







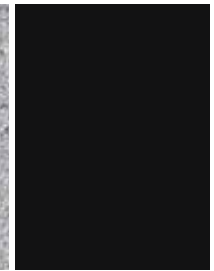

814
GLOSS SLATE

Ambiance Bain furniture is manufactured from several different board and foil materials, which are sourced from varying eco friendly European suppliers. Whilst every effort is made to find materials with matching colour and grain patterns it is inevitable that there will be some shade and pattern differences between different materials advertised as the same colour. Wood grain pattern orientations may differ on niches, tall units, fillers, bath panels and plinths due to the dimensional limitations of the raw materials used. All doors, drawers and fascias are made independently. No grain patterns or designs continue from one fascia to another, in any direction, on any Ambiance Bain units. Curved laminate doors, fascias and some worktops will have a visible hand finished "joint line" where the 2 opposing sheets of laminate meet at the top and bottom edge. This is part of the normal manufacturing process. Every Ambiance Bain retailer has samples of all material finishes available for perusal and approval. Please ensure that you and your clients are happy with any and all colour, grain and shade matches prior to ordering any furniture.

SMO™ WORKTOPS, BASINS & SHOWERS COLOURS

						
200 GLOSS WHITE	201 MATT WHITE	206 MULBERRY GALAXY GLOSS	212 ARTIC GALAXY GLOSS	214 SILVER GALAXY GLOSS	218 PLATINUM GALAXY GLOSS	221 (SHOWERS ONLY) LAVA
						
226 NOUGAT GALAXY GLOSS	234 BLIZZARD GALAXY GLOSS	245 GREIGE SATIN	258 GRANITE GALAXY GLOSS	267 NOUGAT SATIN	268 NOUGAT GLOSS	273 POMPADOUR
						
277 SAFARI	294 COGNAC GALAXY GLOSS	304 SONORA GALAXY GLOSS	314 GLACIER GALAXY SATIN	315 IVORY SATIN	316 PEWTER GALAXY SATIN	317 KAOLIN SATIN
				<p>Check website for RAL colour chart</p> 		
365 FJORD	T231 (SHOWERS ONLY) POLARIS	T233 (SHOWERS ONLY) ATLAS	RAL Allow an additional 3 weeks delivery +30%			

staron® SOLID SURFACE WORKTOP COLOURS

						
R010 MATT WHITE	R143 CREMA	R412 SNOW STORM	R420 GRIS	R423 COMET	R440 SAHARA	R811 PEBBLE ICE



Ab
ambiance bain

www.ambiancebain.co.uk

Ambiance Bain
15 Cranford Court - Hardwick Grange
Woolston - Warrington - WA1 4RX
Tel: 01925 852675 - sales@ambiancebain.com